

Stays strong when things get tight.

LR 11000

Raupenkran • Crawler Crane
Grue sur chenilles • Gru cingolata
Grúa sobre cadenas • Гусеничный кран

LIEBHERR

Mobile and Crawler Cranes



1000 t



168 m



108 m +
114 m



250 t



130 t



450 t



9,2 m



Technische Daten

Technical Data · Caractéristiques technique · Dati tecnici · Datos técnicos · Технические данные

Technische Beschreibung

Technical description · Description technique · Descrizione tecnica · Descripción técnica · Технические данные 4–9

Maße

Dimensions · Encombrement · Dimensioni · Dimensiones · Габариты крана 10–14

Krandaten

Crane data · Dates de la grue · Dati gru · Características · Технические характеристики крана 15

Transportplan

Transportation plan · Plan de transport · Piano di trasporto · Esquema de transporte · Транспортна 16–17

Auslegersysteme

Boom/jib combinations · Configurations de flèche · Sistema braccio · Sistemas de pluma

Стреловые системы 18–25

SL 26–27

S2 28–29

SDB/SDBV/SDBW 30–32

SL2DB/SL2DB2/SL2DBW 33–35

S2DB/S2DB2/S2DBW 36–37

PDB/PDBW 38–39

SW1 40–45

SDWB/SDWBV/SDWBW 46–71

PDW3B/PDW3BW 72–92

SL8F2 93–97

SL10DF2B/BV 98–101

SL9 102–103

SL11DB/BV 104–105

Symbolerklärung

Description of symbols · Explication des symboles · Legenda simboli

Descripción de los símbolos · Объяснение символов 106

Anmerkungen

Remarks · Remarques · Note · Observaciones · Примечани 107

Customer Service 108

Ausstattung

Max. Tragkraft	1000 t bei 11 m Ausladung. SDBW – System mit S 42 m und D 36 m.
Max. Lastmoment	15.171 tm – 471,1 t bei 32 m Ausladung. SL2DBW – System mit S 66 m und D 42 m.

Raupenfahrwerk

Fahrwerk	Liebherr-Raupenfahrwerk, bestehend aus einem Mittelstück und zwei Raupenträgern mit Raupenplatten 2 m (optional 2,4 m) und 4-fach Antrieb.
Zentralballast	2 Konsolen à 5 t. 8 Ballastplatten à 10 t. Gesamtzentralballast 90 t (optional 130 t).



Kranoberwagen

Drehbühnenrahmen	Liebherr-Drehbühnenrahmen, bestehend aus Drehbühne mit Winde IV und abnehmbaren SA-Bock und Rollendrehverbindung.
Kranmotor	Liebherr 8-Zylinder-Diesel, wassergekühlt, Leistung 500 kW (680 PS), max. Drehmoment 3165 Nm. Kraftstoffbehälter: ca. 1500 l. Abgasemissionen entsprechend Richtlinien 97/68/EG und EPA/CARB.
Winde I	Standard Hubwinde, hydraulisch angetrieben mit Axialkolben-Verstellpumpen mit integriertem Planetengetriebe.
Winde IV	Einziehwerk.
Einscherwinde	Hilfswinde zum Einscheren der Seile.
Drehwerk	2 Drehwerke, hydraulisch angetrieben durch Axialkolben-Verstellpumpen mit integriertem Planetengetriebe.
Krankabine	Klimatisierte Krankabine nach hinten neigbar mit Sicherheitsverglasung, wärmedämmendes Glas, Dachfenster mit Panzerglas, genormte Steuereinheiten ergonomisch angeordnet. Thermostatisch geregelte Warmwasser-Zusatzheizung.
Kransteuerung	Alle Kranbewegungen werden durch zwei 4-Wege Meisterschalter sowie zwei 2-Wege Hand-/Fußhebel gesteuert. Alle Arbeitsbewegungen können unabhängig voneinander angesteuert werden.
Sicherheitseinrichtungen	Hubendschalter, Sicherheitsventile gegen Schlauch- und Rohrbruch. Seiltrommel-Endschaltung mit 3 Sicherheitswindungen. Windwarnanlage. Elektronische Neigungsanzeige. Flugwarnleuchte.
Kamera-Überwachung	2 Farbmonitore, 3 Kameras für Winden- und Heckbereich.
Gegengewicht	2 Konsolen mit je 5 t. Gesamtgegengewicht 250 t. 24 Ballastplatten à 10 t (Option).



Auslegersysteme

Hauptausleger S	System S3228 mit Kopfstück für max. Tragkraft von 1000 t. Auslegerlänge SDB 42 m – 108 m mit Derricksystem.
Hauptausleger S2	System S3228 mit Kopfstück für max. Tragkraft von 650 t. Auslegerlänge S218 m – 102 m. Auslegerlänge S2DB 42 m – 156 m mit Derricksystem.
Hauptausleger P	System L2722/S3228 mit Kopfstück für max. Tragkraft von 1000 t. Auslegerlänge PDB 48 m – 138 m. Auslegerlänge PDB2/BW 48 m – 150 m.
Hauptausleger SL	System S3228/L2722 mit Kopfstück für max. Tragkraft von 650 t. Auslegerlänge SL18 m – 114 m.
Hauptausleger SL2	System S3228/L2722 mit Kopfstück für max. Tragkraft von 650 t. Auslegerlänge SL2DB 42 m – 156 m.
Hauptausleger SL8	System S3228/L2722 mit fester Gitterspitze F2. Auslegerlänge SL8 84 m – 108 m Auslegerlänge SL8 102 m – 132 m.
Hauptausleger SL9	System S3228/L2722 mit Kopfstück für max. Tragkraft von 650 t. Auslegerlänge SL9 78 m – 102 m Auslegerlänge SL9D 96 m – 126 m.
Hauptausleger SL10	System S3228/L2722 mit fester Gitterspitze F2. Auslegerlänge SL10 72 m – 168 m.
Hauptausleger SL11	System S3228/L2722 mit Kopfstück für max. Tragkraft von 650 t. Auslegerlänge SL11D 66 m – 162 m.
Feste Gitterspitze F2	Für maximale Traglast von 253 t und integrierter Mastnase, anbaubar unter 10°, 15°, 20° Auslegerlänge F 12 m – F 39 m.
Wippbare Gitterspitze W	System S3228/L2722 mit Kopfstück für max. Tragkraft von 650 t. Wippspitzenlängen 30 m – 114 m.
Derricksystem D	System 2825 einschließlich Abspannstangen.
Ballastpalette B	Für max. Derrickballast von 450 t und stufenlos variable Radien von 12 m – 20 m. Max. Radius von 30 m nur mit Führungsrahmen (B2).
V-Frame BV	Für max. Derrickballast von 450 t und stufenlos variable Radien von 13 m – 30 m.
Ballastwagen BW	Für max. Derrickballast von 450 t bei max. Radius von 30 m, für stufenlos variable Radien von 13 m – 18 m, 17 m – 22 m, 21 m – 26 m, 25 m – 30 m.
Derrickballast	Ballastpalette mit VarioTray (Option). 10 t Gegengewichtsplatten für ein Gesamtgewicht von 450 t.
Winde II	2. Hubwinde.
Winde III	Verstellung Hauptausleger/Derrickbetrieb.
Winde V	Verstellung wippbare Gitterspitze.
Winde VI	Hilfshubwerk.
Mastnase 32 t	Zum Anbau am S oder L-Kopf.

Zusatzausrüstung

Mech. Zusatzabstützung	Zum Aufrichten von langen Auslegerkombinationen ohne Derricksystem.
Hydr. Montageabstützung	Anheben des Grundgeräts zum Auf-/Abbau. Bestehend aus 4 Abstützylindern einschließlich Abstützplatten, angebaut am Mittelstück.
Hydr. Montagezylinder	Zur Selbstmontage/Demontage des Raupenfahrwerks.
Bolzenzieheinrichtung	Einschließlich mobilem Hydraulikaggregat. Zur Montage/Demontage der Bolzen am Raupenfahrwerk und Mittelstück sowie der Ausleger-Zwischenstücke.

Weitere Zusatzausrüstungen auf Anfrage. Serienausrüstung und Optionen entsprechend aktueller Preisliste.

Equipment

Max. capacity	1000 t at 11 m radius SDBW – System with S 42 m and D 36 m.
Max. load moment	15.171 tm – 471.1 t at 32 m radius. SL2DBW – System with S 66 m and D 42 m.

Crawler travel gear

Crawler chassis	Liebherr crawler chassis consisting of one centre section and two crawler carriers with crawler plates 2 m (optional 2.4 m) and quadruple drive.
Central ballast	2 brackets 5 t each. 8 ballast plates 10 t each. Total central ballast 90 t (optional 130 t).



Crane superstructure

Superstructure frame	Liebherr slewing platform frame, consisting of the slewing platform with winch IV and removable SA frame and roller turning connection.
Crane engine	8-cylinder diesel engine, make Liebherr, watercooled, rated power 500 kW (680 h.p.), max torque 3165 Nm. Fuel tank approx. 1500 l, exhaust emission according to directive 97/68/EG and EPA/CARB.
Winch I	Standard hoist drum, hydraulically driven by axial-piston swivel pumps with integrated planetary gear.
Winch IV	Boom hoist.
Reeving winch	Auxiliary winch for the reeving of ropes.
Slewing gear	2 slewing gears, hydraulically powered by axial-piston swivel pump, with integrated planetary gear.
Crane cabin	Air conditioned crane cabin tiltable to the rear with safety glazing, heat insulating glass, roof window with bullet proof glass, standardized control units ergonomically positioned. Additional thermostatically controlled hot water heating.
Crane control	All crane movements are initiated by means of two 4-way joystick hand levers and two 2-way hand/foot levers. All working movements are independently controllable.
Safety devices	Hoist limit switch. Safety valves against hose and pipe rupture. Drum switch limit at 3 rest layers. Wind speed gauge. Electronic inclination indicator. Aircraft warning control light.
Camera observation	2 colour-screens, 3 cameras for winches and rear area.
Counterweight	2 brackets 5 t each. Total counterweight at superstructure 250 t. 24 ballast plates 10 t each (option).



Boom system

Main boom S	System S3228 with head section for max. 1000 t load capacity. Boom length SDB 42 m – 108 m with derrick system.
Main boom S2	System S3228 with head section for max. 650 t load capacity. Boom length S2 18 m – 102 m. Boom length S2DB 42 m – 156 m with derrick system.
Main boom P	System L2722/S3228 with head section for max. 1000 t load capacity. Boom length PDB 48 m – 138 m. Boom length PDB2/BW 48 m – 150 m.
Main boom SL	System S3228/L2722 with head section for max. 650 t load capacity. Boom length SDB 18 m – 114 m.
Main boom SL2	System S3228/L2722 with head section for max. 650 t load capacity. Boom length SL2DB 42 m – 156 m.
Main boom SL8	System S3228/L2722 with fixed lattice jib F2, boom length SL8 84 m – 108 m, boom length SL8 102 m – 132 m.
Main boom SL9	System S3228/L2722 with head section for maximum lifting capacity of 650 t. Boom length of SL9 78 m – 102 m boom length of SL9D 96 m – 126 m.
Main boom SL10	System S3228/L2722 with fixed lattice jib F2, boom length SL10 72 m – 168 m
Main boom SL11	System S3228/L2722 with head section for maximum lifting capacity of 650 t. Boom length of SL11D 66 m – 162 m.
Fixed lattice fly jib F2	For maximum lifting capacity of 253 t and integral runner, can be attached at angles of 10°, 15° and 20°, boom length F 12 m – F 39 m.
Lattice type luffing fly jib W	System S3228/L2722 with head section for max. 650 t load capacity. Luffing jib lengths 30 m – 114 m.
Derrick system D	System 2825 including guy rods.
Counterweight frame B	For max. derrick counterweight of 450 t, for infinitely variable radius from 12 m – 20 m. Max. radius of 30 m only with guiding frame (B2).
V-frame BV	For max. derrick ballast of 450 t and infinitely variable radii from 13 m – 30 m.
Counterweight trailer BW	For maximum derrick ballast of 450 t with a maximum radius of 30 m, for infinitely variable radii of 13 m – 18 m, 17 m – 22 m, 21 m – 26 m, 25 m – 30 m.
Derrick-Counterweight	Ballast pallet with VarioTray (option). 10 t counterweight slabs for a total weight of 450 t.
Winch II	Second hoist winch.
Winch III	Reeving main boom / Derrick operation.
Winch V	Luffing for W-jib configuration.
Winch VI	Auxiliary hoist gear.
Whip line 32 t	For attaching to the S or L head.

Additional equipment

Mechanical outriggers	For erecting long boom combinations without derrick system.
Hydraulic assembly jacks	Lifting of the basic machine for assembly/disassembly. Consisting of 4 lifting cylinders with supporting plates, installed on the centre part.
Hydraulic assembly cylinder	For assembly/disassembly of the crawler carrier by the crane itself.
Pin pulling device	Including mobile hydraulic aggregate. For assembly/disassembly of the pins at the crawler chassis and centre part as well as the boom sections.

Other items of equipment available on request. Standard equipment and options according to effective price list.

Équipement

Capacité max.	1000 t pour une portée de 11 m. Système SDBW avec S 42 m et D 36 m.
Couple de charge max.	15.171 tm – 471,1 t pour une portée de 32 m. Système SL2DBW avec S 66 m et D 42 m.

Train de chenilles

Mécanisme de translation Le train de chenilles Liebherr est composé d'une partie centrale et de deux longerons avec patins de chenilles 2 m (en option 2,4 m) et un entraînement à 4 positions.

Contrepoids central 2 consoles de 5 t. 8 plaques de lest de 10 t. Contrepoids central total 90 t (en option 130 t).



Partie tournante

Cadre de la partie tournante	Châssis de plate-forme tournante Liebherr, composé d'une plate-forme tournante avec treuil IV, chevalet SA amovible et couronne d'orientation à rouleaux.
Moteur de la grue	Diesel Liebherr 8 cylindres, refroidissement par eau, puissance 500 kW (680 ch), couple de rotation max. 3165 Nm. Réservoir de carburant: env. 1500 l. Emissions polluantes conformes aux normes 97/68/EG et EPA/CARB.
Treuil I	Treuil de levage standard, il est entraîné hydrauliquement par des pompes à débit variable à pistons axiaux avec réducteur planétaire intégré.
Treuil IV	Mécanisme de relevage.
Treuil de mouflage	Treuil auxiliaire pour le mouflage des câbles.
Mécanisme d'orientation	Deux mécanismes d'orientation, il est entraîné hydrauliquement par des pompes à débit variable à pistons axiaux avec réducteur planétaire intégré.
Cabine du grutier	La cabine du grutier est climatisée, inclinable vers l'arrière, possède un vitrage de sécurité, un vitrage isolant thermiquement, une fenêtre de toit en verre blindé, des unités de commande normalisées disposées de façon ergonomique. Chauffage d'appoint et chauffage de l'eau régulé thermostatiquement.
Commande de la grue	Tous les mouvements de la grue sont commandés par deux manipulateurs à 4 voies et deux pédale/levier à 2 voies. Tous les mouvements de travail peuvent être commandés indépendamment.
Dispositifs de sécurité	Interrupteur de fin de course. Clapets de sécurité contre les ruptures de tuyaux et de flexibles. Coupure de fin de course du tambour avec 3 enroulements de sécurité. Anémomètre de sécurité. Inclinomètre électronique. Balise aérienne.
Contrôle vidéo	2 écrans couleur, 3 caméras pour la zone de treuils et la partie arrière.
Contrepoids	2 consoles de 5 t chacune. Contrepoids total 250 t. 24 plaques de lest à 10 t (option).



Système de flèche

Flèche principale S	Système S3228 avec élément de tête pour une capacité max. de 1000 t. Longueur de la flèche SDB 42 m – 108 m avec système derrick.
Flèche principale S2	Système S3228 avec élément de tête pour une capacité max. de 650 t. Longueur de la flèche S2DB 42 m – 156 m avec système derrick.
Flèche principale P	Système L2722/S3228 avec élément de tête pour une capacité max. de 1000 t. Longueur de la flèche PDB 48 m – 138 m. Longueur de la flèche PDB2/BW 48 m – 150 m.
Flèche principale SL	Système S3228/L2722 avec élément de tête pour une capacité max. de 650 t. Longueur de la flèche SL 18 m – 114 m.
Flèche principale SL2	Système S3228/L2722 avec élément de tête pour une capacité max. de 650 t. Longueur de la flèche SL2DB 42 m – 156 m.
Flèche principale SL8	Système S3228/L2722 avec pointe de flèche en treillis fixe F2. Longueur de flèche SL8 84 m – 108 m, longueur de flèche SL8 102 m – 132 m.
Flèche principale SL9	Système S3228/L2722 avec élément de tête pour une capacité de charge de 650 t. Longueur de flèche SL9 78 m – 102 m. Longueur de flèche SL9D 96 m – 126 m.
Flèche principale SL10	Système S3228/L2722 avec pointe de flèche en treillis fixe F2. Longueur de flèche SL10 72 m – 168 m.
Flèche principale SL11	Système S3228/L2722 avec élément de tête pour une capacité de charge de 650 t. Longueur de flèche SL11D 66 m – 162 m.
Fléchette treillis fixe F2	Pour capacité de charge maximale de 253 t et extrémité de mât intégrée, montage possible sous 10°, 15°, 20°, longueur de flèche F 12 m – F 39 m.
Fléchette treillis à volée variable W	Système S3228/L2722 avec élément de tête pour une capacité max. de 650 t. Longueurs de flèche treillis 30 m – 114 m.
Système derrick D	Le système 2825 comprend des tirants.
PaLETTE de lest B	Pour un contrepoids derrick max. de 450 t et rayons variables progressivement de 12 m – 20 m. Rayon max. de 30 m uniquement avec cadre de guidage (B2).
V-Frame BV	Pour un contrepoids derrick de 450 t max. et des rayons variables progressivement de 13 m – 30 m.
Remorque à contrepoids BW	Pour un contrepoids derrick de 450 t avec un rayon de 30 m, pour des rayons variables progressivement de 13 m – 18 m, 17 m – 22 m, 21 m – 26 m, 25 m – 30 m.
Contrepoids derrick	Plaque lest avec VarioTray (Option). 10 t de plaques de contrepoids pour un poids total de 450 t.
Treuil II	2. treuil de levage.
Treuil III	Réglage flèche principale/mode derrick.
Treuil V	Réglage fléchette treillis à volée variable.
Treuil VI	Treuil de levage auxiliaire.
Poules en extrémité de mât 32t	Pour le montage sur la tête S ou L.

Équipement additionnel

Stab. additionnel mécanique Pour le relevage de longues combinaisons de flèches sans système de derrick.

Stabilisateurs hydrauliques de montage Ils soulèvent l'engin de base pour le montage/démontage. Ils sont constitués de 4 vérins de calage dont les patins de calage montés sur l'élément central.

Vérin hydraulique de montage Pour le montage autonome/démontage du train de chenilles.

Dispositif d'extraction des axes Il est constitué du composant hydraulique mobile. Pour le montage/démontage des goujons au niveau des chenilles et de l'élément central ainsi que pour celui des pièces intermédiaires de la flèche.

D'autres équipements additionnels sont disponibles sur demande. Les équipements de série et les options correspondent à la liste de prix actuelle.

Equipaggiamento

Capacità max.	1000 t a 11 m di raggio di lavoro Sistema SDBW con S 42 m e D 36 m.
Momento di carico max.	15.171 tm - 471,1 t a 32 m di raggio di lavoro. Sistema SL2DBW con S 66 m e D 42 m.

Carro cingolato

Carro	Carro cingolato Liebherr, costituito da una sezione centrale, due traverse con cingoli da 2 m (optional 2,4 m) e 4 motori di traslazione.
Zavorra centrale	2 piastre da 5 t cadauna. 8 piastre zavorra da 10 t cadauna. Zavorra centrale totale 90 t (optional 130 t).



Torretta

Telaio ralla di rotazione	Telaio piattaforma girevole Liebherr, composto da piattaforma girevole con verricello IV e telaio ad SA e ralla a rulli rimovibili.
Motore gru	Motore diesel 8 cilindri Liebherr, raffreddamento ad acqua, 500 kW (680 CV), coppia max. 3165 Nm. Serbatoio carburante ca. 1500 l. Emissioni gas di scarico in base alle direttive CE 97/68 e EPA/CARB.
Argano I	Argano standard, azionamento idraulico con pompe a cilindrata variabile a pistoncini assiali con riduttore epicicloidale integrato.
Argano IV	Argano per impennamento del braccio.
Verricello per armare le funi	Verricello ausiliario per armamento funi.
Motore di rotazione	Due motori di rotazione, azionamento idraulico con pompe a cilindrata variabile a pistoncini assiali con riduttore epicicloidale integrato.
Cabina gru	Cabina gru climatizzata, reclinabile con vetratura di sicurezza, vetri a isolamento termico, tettuccio con vetro di sicurezza, unità comandi standard e ergonomiche. Riscaldamento addizionale ad acqua regolabile termostaticamente.
Comandi gru	Tutte le movimentazioni gru vengono comandate da due manipolatori principali a 4 movimenti e due pedali a 2 movimenti. Tutte le movimentazioni di lavoro possono essere eseguiti indipendentemente.
Dispositivi di sicurezza	Interruttore fine corsa. Valvola di sicurezza per evitare rottura dei tubi. 3 avvolgimenti di sicurezza della fune sui tamburi argani. Anemometro. Indicatori elettronici di inclinazione. Dispositivo segnalazione luci aeree.
Telecamera controllo	2 telecamere con monitor a colori. 3 telecamere per gli argani e per la parte posteriore.
Contrappeso	2 piastre da 5 t cadauna. Contrappeso totale 250 t. 24 piastre zavorra da 10 t cadauna (optional).



Sistemi braccio

Braccio principale S	Sistema S3228 con testa braccio per portata max. 1000 t. Lunghezza braccio SDB 42 m - 108 m con sistema Derrick.
Braccio principale S2	Sistema S3228 con testa braccio per portata max. 650 t. Lunghezza braccio S2 18 m - 102 m. Lunghezza braccio S2DB 42 m - 156 m con sistema Derrick.
Braccio principale P	Sistema L2722/S3228 con testa braccio per portata max. 1000 t. Lunghezza braccio PDB 48 m - 138 m. Lunghezza braccio PDB2/BW 48 m - 150 m.
Braccio principale SL	Sistema S3228/L2722 con testa braccio per portata max. 650 t. Lunghezza braccio SL 18 m - 114 m.
Braccio principale SL2	Sistema S3228/L2722 con testa braccio per portata max. 650 t. Lunghezza braccio SL2DB 42 m - 156 m.
Braccio principale SL8	Sistema S3228/L2722 con punta a griglia fissa F2. Lunghezza braccio SL8 84 m - 108 m Lunghezza braccio SL8 102 m - 132 m.
Braccio principale SL9	Sistema S3228/L2722 con testata per una portata massima di 650 t. Lunghezza braccio SL9 78 m - 102 m Lunghezza braccio SL9D 96 m - 126 m.
Braccio principale SL10	Sistema S3228/L2722 con punta a griglia fissa F2. Lunghezza braccio SL10 72 m - 168 m.
Braccio principale SL11	Sistema S3228/L2722 con testata per una portata massima di 650 t. Lunghezza braccio SL11D 66 m - 162 m.
Falcone fisso F2	Per una portata massima di 253 t e naso del palo integrato, applicabile sotto 10°, 15°, 20° lunghezza braccio F 12 m - F 39 m.
Falcone variabile W	Sistema S3228/L2722 con testa braccio per portata max. 650 t. Lunghezza braccio 30 m - 114 m.
Sistema Derrick D	Sistema 2825 inclusi gli stralli.
Telaio per contrappeso B	Per max. 450 t di zavorra Derrick e raggi variabili da 12 m a 20 m. Raggio max di 30 m solo con telaio guida (B2).
V-Frame BV	Per contrappeso Derrick max di 450 t e raggi infinitamente variabili di 13 m - 30 m.
Carrello contrappeso BW	Per zavorra Derrick max di 450 t con raggio max di 30 m, per raggi infinitamente variabili 13 m - 18 m, 17 m - 22 m, 21 m - 26 m, 25 m - 30 m.
Zavorra Derrick	Telaio per contrappeso con VarioTray (Option). Piastre contrappeso da 10 t per totali 450 t.
Argano II	2. argano.
Argano III	Regolazione braccio principale/utilizzo Derrick.
Argano V	Regolazione falcone variabile.
Argano VI	Argano ausiliario.
Puleggia 32 t	Per montaggio su testa braccio S o L.

Equipaggiamento addizionale

Stabilizzazione meccanica addizionale	Per la realizzazione di combinazioni di bracci lunghe senza sistema derrick
Stabilizzazione montaggio idraulico	Sollevamento della macchina base per montaggio e smontaggio. Consiste in 4 cilindri stabilizzatori incl. piatti di stabilizzazione, montati sulla sezione centrale.
Cilindro di montaggio idraulico	Per montaggio/smontaggio automatico del carro cingolato.
Dispositivo per estrazione perni	Compresi idraulica cellulare aggregato. Per blocco e sblocco perni del carro cingolato, della sezione centrale e degli elementi intermedi braccio.

Ulteriore equipaggiamento su richiesta. Equipaggiamento di serie e optionals conforme al listino prezzi attuale.

Equipamiento

Máx. capacidad de carga	1000 t para 11 m de radio de trabajo. Sistema SDBW – con 42 m de S y 36 m de D.
Momento de carga máx.	15.171 tm – 471,1 t para 32 m de radio de trabajo. Sistema SL2DBW – con 66 m de S y 42 m de D.

Chasis sobre cadenas

Mecanismo de traslación	Sistema de traslación de Liebherr, compuesto por una estructura central, dos vigas centrales, y porta orugas con tejas de 2 m (opcional 2,4 m) y 4 motores de traslación.
Contrapeso central	2 consolas de 5 t. 8 placas de contrapeso de 10 t cada una. Contrapeso total 90 t (opcional 130 t).



Superestructura

Bastidor de superestructura	Bastidor de plataforma de giro de Liebherr, formado por la plataforma de giro con torno IV, el caballete SA y el rodamiento de giro desmontables.
Motor de grúa	Diesel de 8 cilindros, Fabricante Liebherr, refrigerado por agua, potencia 500 kW (680 CV), par de giro máx. 3165 Nm. Depósito de combustible alrededor 1500 l. Emisiones Co2 según normativa 97/68/EG y EPA/CARB.
Cabrestante I	Cabrestante estándar, accionado hidráulicamente, con bombas variables con pistones axiales con caja de transferencia integrada.
Cabrestante IV	Sistema de elevación.
Cabrestante de reenvíos	Cabrestante auxiliar para reenvíos.
Mecanismo de giro	Dos mecanismos de giro, accionados hidráulicamente con bomba variable de pistones axiales con caja de transferencia integrada.
Cabina de grúa	Cabina de grúa climatizada inclinable hacia atrás con acristalamiento de seguridad, cristal con sistema de reducción de calor, cristal antichoque en techo de grúa, sistema de mando normalizado y ergonómico. Calefacción adicional regulada con termostato.
Pilotaje de grúa	Todos los movimientos se efectúan a través de dos joysticks de 4 movimientos así como también dos movimientos son accionables desde el mando o pedal. Todos los movimientos de trabajo son accionables de forma independiente.
Dispositivos de seguridad	Interruptor de fin de carrera de elevación, válvulas de seguridad contra rotura de tuberías y latiguillos. Final de carrera de cabrestante, con 3 vueltas de seguridad. Anemómetro. Dispositivo de inclinación electrónico. Baliza aérea.
Supervisión por cámara	2 monitores a color, 3 cámaras para zona de cabrestante y parte trasera.
Contrapeso	2 consolas con cada una de 5 t. Contrapeso total de 250 t. 24 placas de contrapeso a 10 t cada una (opción).



Sistemas de pluma

Pluma principal S	Sistema S3228 con cabezal para máx. capacidad de carga de 1000 t. Longitud de pluma SDB 42 m – 108 m con sistema Derrick.
Pluma principal S2	Sistema S3228 con cabezal para máx. capacidad de carga de 650 t. Longitud de pluma S2 18 m – 102 m. Longitud de la pluma S2DB 42 m – 156 m con sistema Derrick.
Pluma principal P	Sistema L2722/S3228 con cabezal para máx. capacidad de carga de 1000 t. Longitud de la pluma PDB 48 m – 138 m. Longitud de la pluma PDB2/BW 48 m – 150 m.
Pluma principal SL	Sistema S3228/L2722 con cabezal para máx. capacidad de carga de 650 t. Longitud de pluma SL 18 m – 114 m.
Pluma principal SL2	Sistema S3228/L2722 con cabezal para máx. capacidad de carga de 650 t. Longitud de pluma SL2DB 42 m – 156 m.
Pluma principal SL8	Sistema S3228/L2722 con plumín de celosía fijo F2. Largo de pluma SL8 de 84 m a 108 m. Largo de pluma SL8 de 102 m a 132 m.
Pluma principal SL9	Sistema S3228/L2722 con cabezal para una capacidad de carga máxima de 650 t. Largo de pluma SL9 de 78 m a 102 m. Largo de pluma SL9D de 96 m a 126 m.
Pluma principal SL10	Sistema S3228/L2722 con plumín de celosía fijo F2. Largo de pluma SL10 de 72 m a 168 m.
Pluma principal SL11	Sistema S3228/L2722 con cabezal para una capacidad de carga máxima de 650 t. Largo de pluma SL11D de 66 m a 162 m.
Plumín fijo F2	Para una capacidad de carga máxima de 253 t y mástil saliente integrado, se puede montar en 10°, 15°, 20°. Largo de pluma de F 12 m a F 39 m.
Plumín abatible W	Sistema S3228/L2722 con cabezal para capacidad de carga máx. de 650 t. Longitud del plumín abatible 30 m – 114 m.
Sistema Derrick D	Sistema 2825 incluidos tirantes de sujeción.
Bandeja de contrapeso B	Para un contrapeso máx. Derrick de 450 t con radios variables escalonados de 12 m – 20 m. Radio de 30 m sólo con guía de celosía al bastidor (B2).
V-Frame BV	Para un lastre Derrick máximo de 450 t y radios de variación continua entre 13 m y 30 m.
Carro de contrapeso BW	Para un lastre Derrick máximo de 450 t con el radio máximo de 30 m, con radios de variación continua entre 13 m y 18 m, 17 m y 22 m, 21 m y 26 m y 25 m y 30 m.
Contrapeso Derrick	Plataforma de lastre con VarioTray (opcional). Placas de contrapeso de 10 t para un peso total de 450 t.
Cabrestante II	Cabrestante II.
Cabrestante III	Abatimiento de la pluma principal / servicio Derrick.
Cabrestante V	Abatimiento del plumín abatible.
Cabrestante VI	Cabrestante auxiliar.
Narices 32 t	Para el montaje en cabezal S o L.

Equipamiento adicional

Apoyos adicionales mecánicos	Para montaje de plumas largas combinadas sin contrapeso Derrick.
Apoyos de montaje hidráulicos	Para elevar la grúa para su montaje/desmontaje. Compuesto por 4 cilindros de apoyo, incluidas placas de apoyo, montadas en el chasis central.
Cilindro hidráulico de montaje	Para el automontaje/desmontaje del chasis.
Dispositivo para embulonamiento	Incluido dispositivo hidráulico. Para el montaje y desmontaje de los bulones de las orugas y chasis central, así como para los tramos intermedios de celosía.

Otro equipamiento adicional bajo sugerencia. Equipamiento de serie y opciones correspondientes al listado de precios actual.

Оснащение

Макс. грузоподъемность	1000 т при вылете 11 м. SDBW – система с S 42 м и D 36 м.
Макс. грузовой момент	15.171 тм – 471,1 т при вылете 32 м. SL2DBW-система с S 66 м и D 42 м.

Гусеничный механизм передвижения

Механизм передвижения Гусеничный механизм передвижения Либхерр, состоящий из гусеничной тележки и двух гусеничных двигателей с траками 2 м (2,4 м опция) и 4-мя приводами.

Центральный балласт 2 консоли по 5 т. 8 плит балласта по 10 т. Общий балласт 90 т (130 т опция).



Поворотная платформа крана

Рама поворотной платформы	Рама поворотной платформы Liebherr, состоящая из поворотной платформы с лебедкой IV, съемной SA-образной рамы и роликового опорно-поворотного устройства.
Двигатель крана	8-цилиндровый дизель, производство Либхерр, водяное охлаждение, мощность 500 кВт (680 л.с.), макс. крутящий момент 3165 нм. Топливный бак: прим. 1500 л. Выброс ОГ в соответствии с директивами по 97/68/EG и EPA/CARB.
Лебедка I	Стандартная грузовая лебедка, гидравлический привод от аксиально-поршневых регулируемых насосов со встроенным планетарным редуктором.
Лебедка IV	Механизм натяжения.
Запасовочная лебедка	Вспомогательная лебедка для запасовки канатов.
Механизм поворота	Два механизма поворота, гидравлический привод от аксиально-поршневых регулируемых насосов со встроенным планетарным редуктором.
Кабина крана	Кабина крана с климат-контролем; отклоняется назад; защитное остекление, детермальное стекло, потолочное окно с броневым стеклом, стандартные устройства управления с эргономичным размещением. Дополнительное отопление горячей водой с управлением от термостата.
Управление крана	Всеми движениями крана можно управлять при помощи двух 4-ходовых командо-контроллеров, а также двух 2-ходовых рычагов ручного или ногового управления. Всеми движениями крана можно управлять независимо друг от друга.
Приборы безопасности	Концевой выключатель подъема, предохранительные клапаны против разрывов труб и шлангов. Отключение по конечному положению канатного барабана с 3-мя предохранительными витками. Предупредительная ветровая сигнализация. Электронная индикация наклона. Сигнальные маяки для самолетов.
Контроль через видеокамеру	2 цветных монитора, 3 камеры заднего вида и контроля лебедок.
Противовес	2 консоли по 5 т. Общий вес противовеса 250 т. 24 плит балласта по 10 т (опция).



Стреловые системы

Основная стрела S	Система S3228 с головной секцией для макс. грузоподъемности 1000 т. Длина стрелы SDB 42 м – 108 м с деррик-системой.
Основная стрела S2	Система S3228 с головной секцией для макс. грузоподъемности 650 т. Длина стрелы S2 18 м – 102 м. Длина стрелы S2DB 42 м – 156 м с деррик-системой.
Основная стрела P	Система L2722/S3228 с оголовком для макс. грузоподъемности 1000 т. Длина стрелы PDB 48 м – 138 м. Длина стрелы PDB2/BW 48 м – 150 м.
Основная стрела SL	Система S3228/L2722 с головной секцией для макс. грузоподъемности 650 т. Длина стрелы SL 18 м – 114 м с деррик-системой.
Основная стрела SL2	Система S3228/L2722 с головной секцией для макс. грузоподъемности 650 т. Длина стрелы SL2DB 42 м – 156 м.
Основная стрела SL8	Система S3228/L2722 с неподвижным решетчатым удлинителем F2. Длина стрелы SL8: 84 – 108 м. Длина стрелы SL8: 102 – 132 м.
Основная стрела SL9	Система S3228/L2722, с насадкой, макс. грузоподъемность 650 т. Длина стрелы SL9: 78 – 102 м. Длина стрелы SL9D: 96 – 126 м.
Основная стрела SL10	Система S3228/L2722 с неподвижным решетчатым удлинителем F2. Длина стрелы SL10: 72 – 168 м.
Основная стрела SL11	Система S3228/L2722, с насадкой, макс. грузоподъемность 650 т. Длина стрелы SL11D: 66 – 162 м.
Жесткомонтируемый решетчатый удлинитель F2	Для максимальной грузоподъемности 253 т и встроенного гуська, монтируемого под углами 10°, 15°, 20°. Длина стрелы F: 12 – 39 м.
Качающийся решетчатый удлинитель W	Система S3228/L2722 с головной секцией для макс. грузоподъемности 650 т. Длина удлинителя с изменяемым вылетом 30 м – 114 м.
Деррик-система D	Система 2825, включая штанги расчала.
Основание противовеса B	Для макс. деррик-балласта 450 т и плавного изменения радиуса 12 м – 20 м. Макс. радиус 30 м – только с направляющей рамой (B2).
V-образная рама BV	Для макс. балласта крана 450 т и плавно варьируемых радиусов 13 – 30 м.
Балластная тележка BW	Для системы балласта макс. 450 т при макс. радиусе 30 м, для плавной регулировки радиусов в диапазоне 13 – 18 м, 17 – 22 м, 21 – 26 м, 25 – 30 м.
Деррик-балласт	Балластный поддон с концепцией Variotray (опция). 10 т плиты противовеса для общей массы противовеса в 450 т.
Лебедка II	2-я грузовая лебедка.
Лебедка III	Наклон главной стрелы / режим деррика.
Лебедка V	Наклон качающегося решетчатого удлинителя.
Лебедка VI	Вспомогательный механизм подъема.
Мачтовый наконечник 32 т	Для установки на оголовке S или L.

Дополнительное оборудование

Механическая дополнительная установка на опоры	Для установки комбинаций стрелы большой длины без системы балласта.
Гидравлические монтажные опоры	Подъем базовой машины для монтажа / демонтажа. Состоит из 4 опорных цилиндров, включая опорные плиты, установленные гусеничной тележке.
Гидравлический монтажный цилиндр	Для самостоятельного монтажа / демонтажа гусеничного механизма передвижения.
Устройство для вытягивания пальцев	Включая мобильный гидравлический агрегат. Для монтажа/демонтажа пальцев на гусеничной тележке и центральной части поворотной платформы, а также секций стрелы.

Другое дополнительное оборудование – по запросу. Серийное оснащение и опции – в соответствии с текущим прайс-листом.

Maße

Dimensions • Encombrement • Dimensioni • Dimensiones • Габариты крана

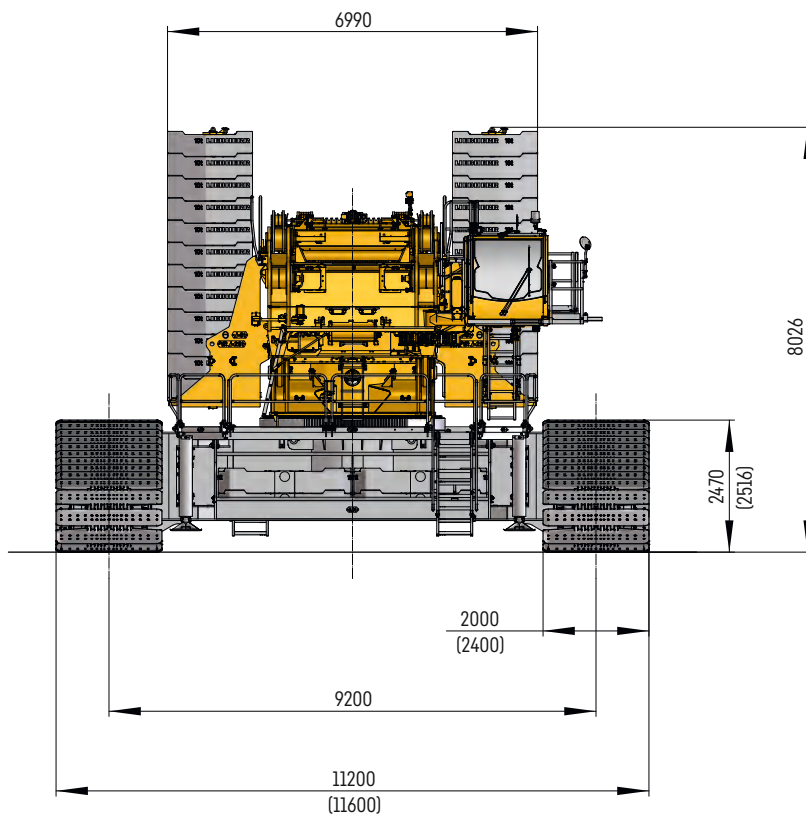
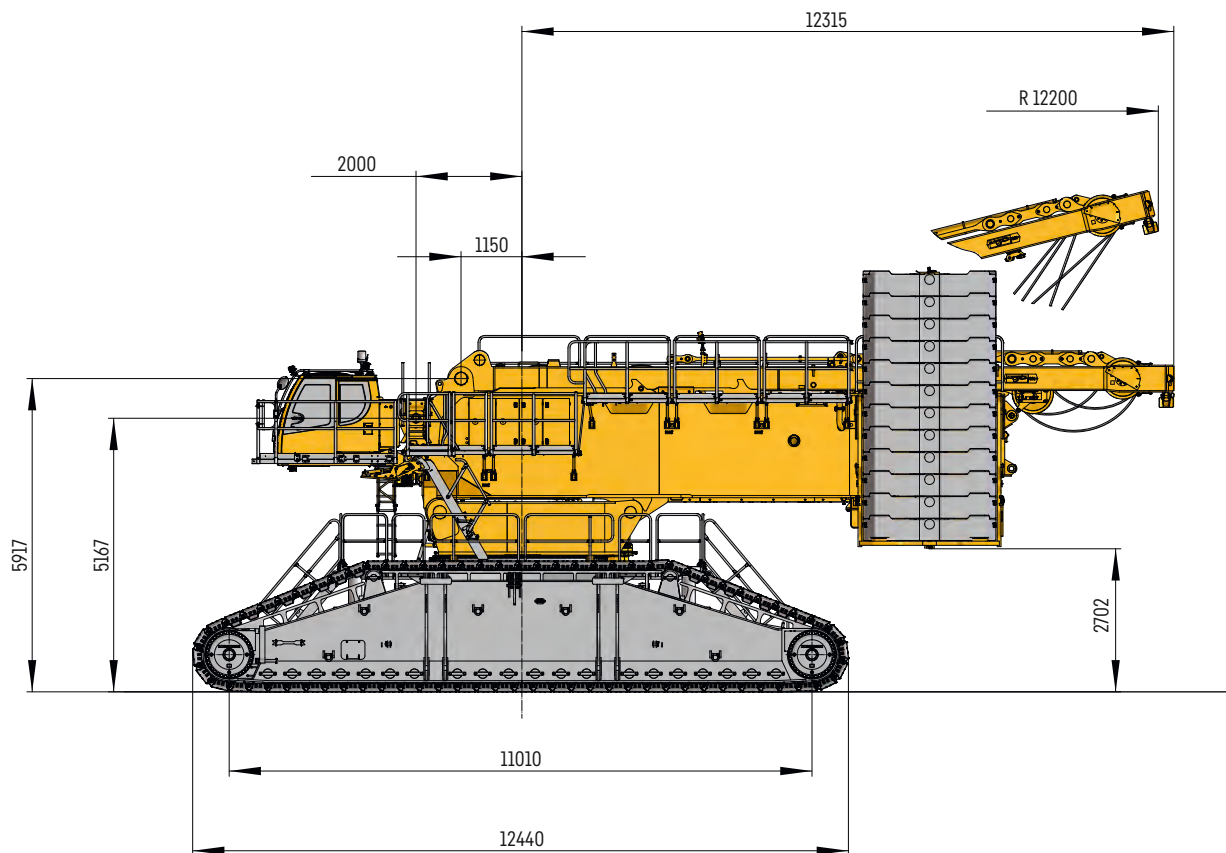

S235-0001-00

Maße

Dimensions • Encombrement • Dimensioni • Dimensiones • Габариты крана

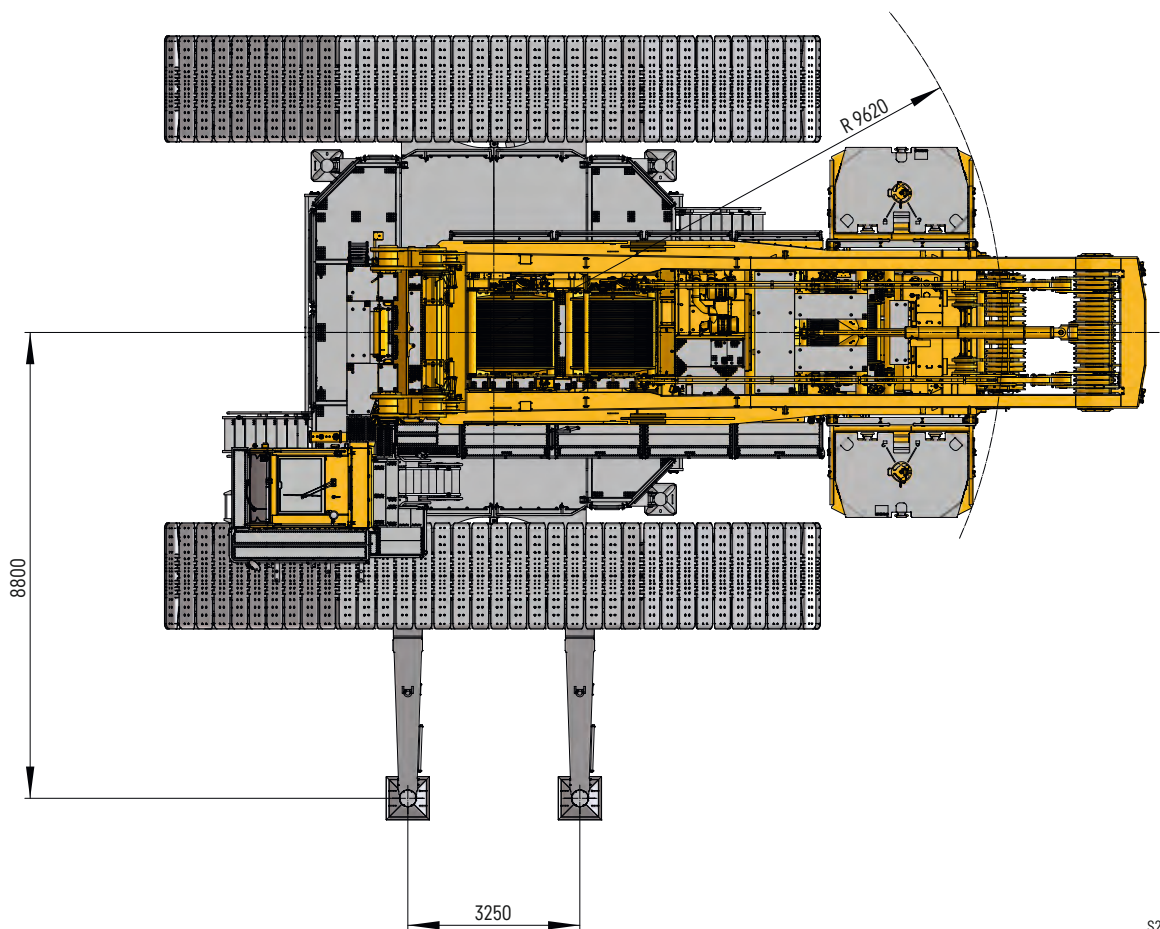

S235-0001-00

Maße

Dimensions • Encombrement • Dimensioni • Dimensiones • Габариты крана

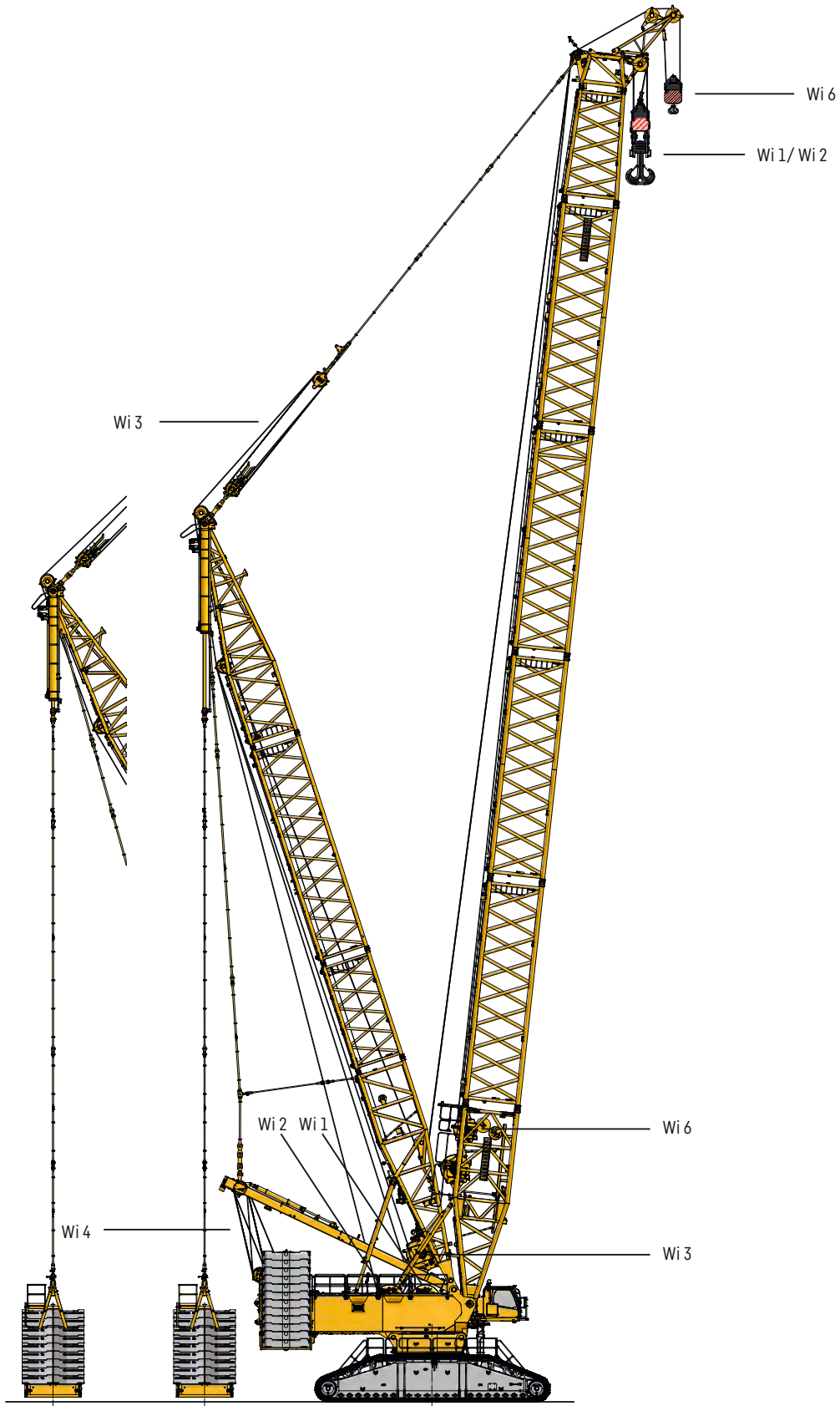

S235-0016-00

Maße

Dimensions • Encombrement • Dimensioni • Dimensiones • Габариты крана

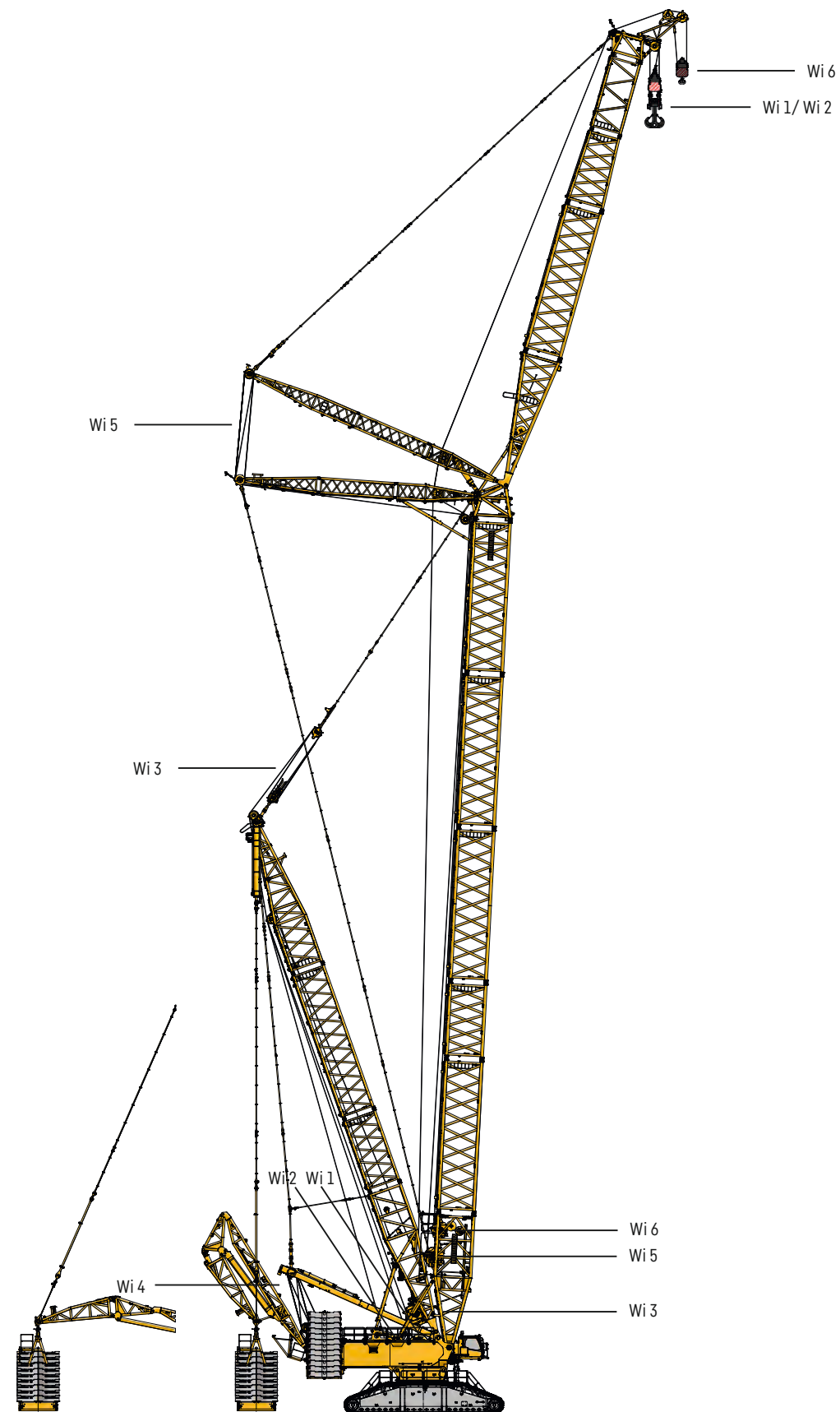

S235-0017-00

Maße

Dimensions • Encombrement • Dimensioni • Dimensiones • Габариты крана



12 m - 20 m

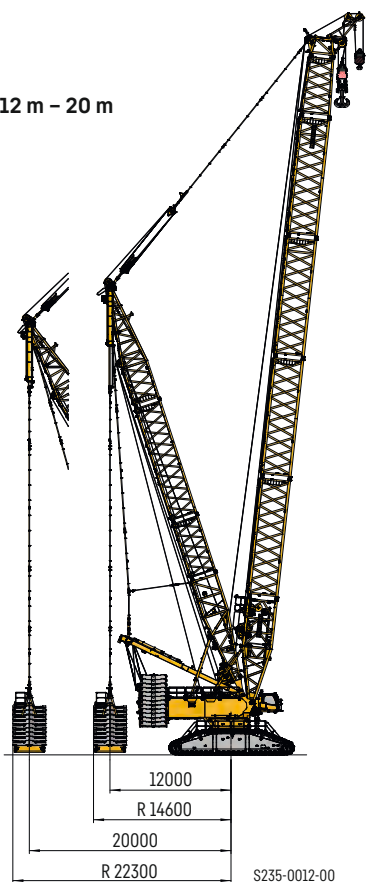

S235-0012-00



13 m - 30 m

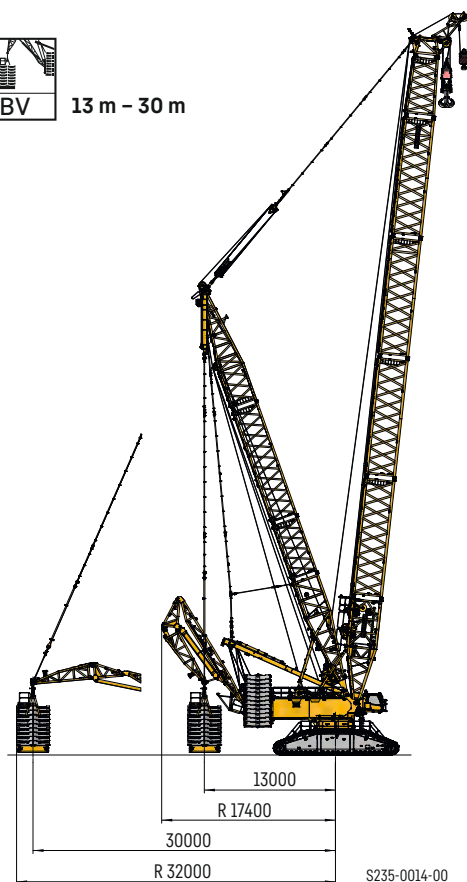

S235-0014-00



20 m, 25 m, 30 m



S235-0013-00



13 m - 30 m







S235-0015-00

Krandaten

Crane data · Dates de la grue · Dati gru · Características · Технические характеристики крана



Winden

Winches · Treuils · Argani · Cabrestantes · Лебедки

	V _{m/min}	 F	 Ø	
1	0 - 120 m/min	230 kN	32 mm	1450 m
2	0 - 120 m/min	230 kN	32 mm	1450 m
3	0 - 115 m/min	-	-	-
4	0 - 2 x 60 m/min	-	-	-
5	0 - 105 m/min	-	-	-
6	0 - 118 m/min	160 kN	28 mm	600 m







Geschwindigkeiten

Working speeds Vitesses · Velocità · Velocidades · Скорости

	Drehgeschwindigkeiten · Slewing speeds · Vitesses d'orientation Velocità di rotazione · Velocidades de giro · Скорости вращения	0 - 0,89 $\frac{\text{min}^{-1}}{\text{min}}$
	Fahrgeschwindigkeiten · Travel speeds · Vitesses de translation Velocità di trasferimento · Velocidades de traslación · Скорости хода	0 - 1,41 km/h

Hakenflaschen



Hook blocks · Moufles à crochet · Bozzello · Pastecas · Крюковые подвески



					
1000 / 550 t (M)	1000 t	32 mm	2 x 13	2 x 25	28,4 / 21,5 t
950 / 480 t	1000 t	32 mm	2 x 11	2 x 23	25,5 - 29,5 / 19,5 - 23,5 t
800 / 400 t	800 t	32 mm	2 x 9	2 x 19	16 - 26 / 12 - 22 t
650 / 325 t	650 t	32 mm	2 x 7	2 x 15	14 - 22 / 10 - 18 t
310 / 155 t	320 t	32 mm	2 x 3	2 x 7	4,7-12,7 / 3,4-11,4 t
240 t	250 t	32 mm	5	11	3 - 11 t
160 t	160 t	32 mm	3	7	2,5 - 8,5 t
68 t	80 t	32 mm	1	3	2,5 - 4,5 t
23 t	25 t	32 mm	-	1	1,5 t

(M) = **Modulflasche** · Module block · Moufle modulaire · Blocco del modulo · Polipasto modular · Модульная обойма полипаста

Einscherplan

Reeving chart · Tableau de mouflage · Piano per armatura funi · Esquema de reenvíos · Схема запасовки

	1	2	3	4	5	6	7	8	9	10	11	12	13	14	15	16	17	18	19	20	21	22	23	24	25	26	27
	23	46	68	91	113	135	157	179	200	221	242	263	284	304	324	344	364	384	403	422	441	460	479	497	515	533	551
23 t																											
68 t																											
160 t																											
240 t																											
325 t																											
400 t																											
480 t																											
550 t																											

	2 x 4	2 x 5	2 x 6	2 x 7	2 x 8	2 x 9	2 x 10	2 x 11	2 x 12	2 x 13	2 x 14	2 x 15	2 x 16	2 x 17	2 x 18	2 x 19	2 x 20	2 x 21	2 x 22	2 x 23	2 x 24	2 x 25	
	182	226	270	314	358	400	442	484	526	568	608	648	688	728	768	806	844	882	920	958	994	1000	
310 t																							
650 t																							
800 t																							
950 t																							
1000 t (M)																							

(M) = **Modulflasche** · Module block · Moufle modulaire · Blocco del modulo · Polipasto modular · Модульная обойма полипаста

Transportplan

Transportation plan · Plan de transport · Piano di trasporto · Esquema de transporte · Транспортна

Raupenmittelteil mit Dreheinrichtung (3 Drehwerke), Breite 3,5 m

Crawler middle section with rotating (3 slewing gears), width 3.5 m

Partie centrale des chenilles avec système de rotation (3 mécanismes d'orientation), largeur 3,5 m

Sezione cingolo centrale con motore di rotazione (3 ralle), larghezza 3,5 m

Chasis de las cadenas con sistema giratorio (3 reductores de giro), anchura 3,5 m

Гусеничная тележка с поворотным устройством (3 механизма поворота), ширина 3,5 м

27,2 t*

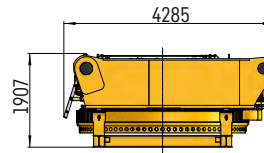

60 t (66,5 t*)

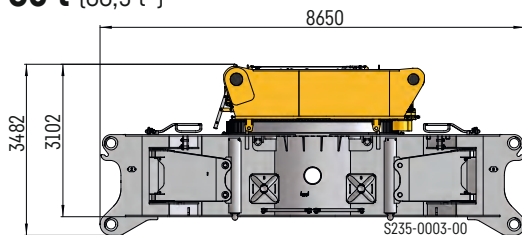

40 t*

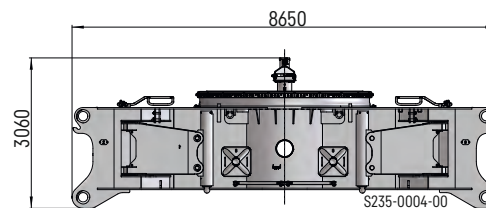

* Option mit Quick Connection / optional with quick connection / en option avec quick connection / optional con connessione rapida / opcional con conexiones rápidas / по заказу с быстрозастывающим соединением

Raupenträger mit 2 Fahrtrieben

Crawler incl. 2 driving gears

Longeron avec 2 mécanismes de translation

Cingoli con 2 motori di trazione

Cadenas - incluidos 2 motores de traslación

Гусеничный движитель с 2-мя ходовыми приводами

2 x 60 t (2 x 67 t)

2,0 m (2,4 m) Breite · width · largeur · larghezza · anchura · ширина

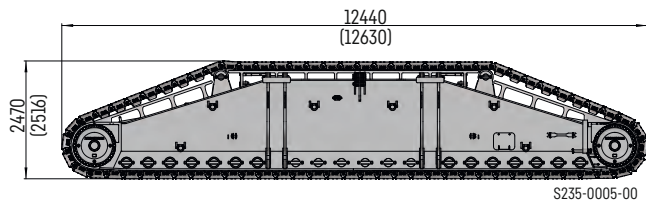

2 x 31 t

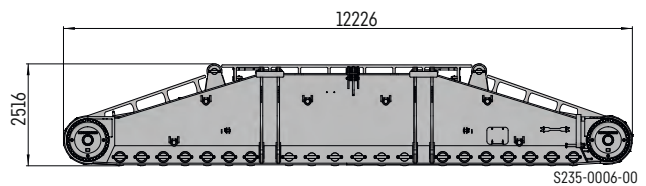

Winde 1/2

Winch 1/2

Treuil 1/2

Argano 1/2

Cabrestante 1/2

Лебедка 1/2

14 t

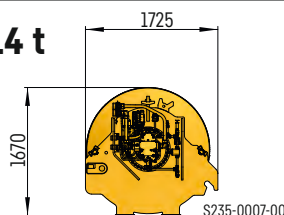

14 t

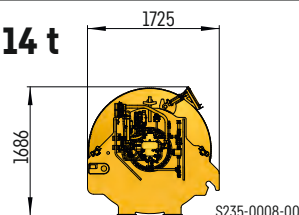

2,12 m Breite · width · largeur · larghezza · anchura · ширина

Transportplan

Transportation plan · Plan de transport · Piano di trasporto · Esquema de transporte · Транспортна

Drehbühne mit SA-Bock, Winde 4 · Superstructure with SA-frame, winch 4, width

Partie tournante avec chevalet SA, treuil 4, largeur · Ralla di rotazione con cavalletto SA, argano 4, larghezza

Superestructura con caballete SA, cabrestante 4, anchura · Поворотная платформа с SA-стойкой, лебедка 4, ширина

78 t

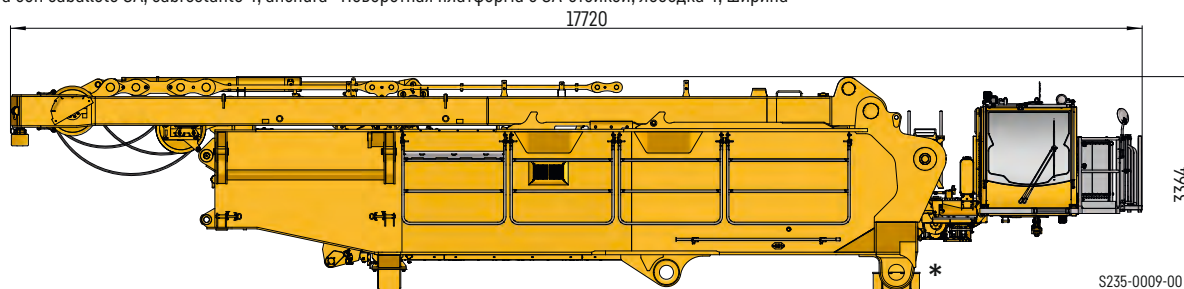

3,5 m Breite · width · largeur · larghezza · anchura · ширина

* + **0,9 t Transportablage** · transport support · t pour le support de transport · ripiano per trasporto · de superficie de transporte · транспортная опора грузоподъемностью

Drehbühne ohne SA-Bock · Superstructure without SA-frame

Partie tournante sans chevalet SA · Ralla di rotazione senza cavalletto SA

Superestructura sin caballete SA · Поворотная платформа без SA-стойкой

46 t

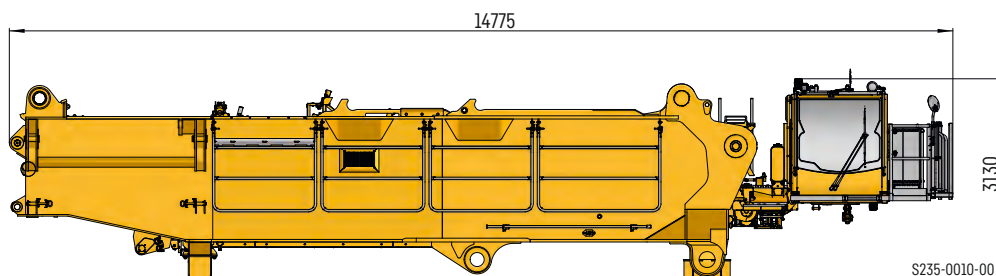

3,5 m Breite · width · largeur · larghezza · anchura · ширина

* + **0,9 t Transportablage** · transport support · t pour le support de transport · ripiano per trasporto · de superficie de transporte · транспортная опора грузоподъемностью

SA-Bock, Winde 4 inkl. Seil und Rollensatz · SA-frame, winch 4 incl. rope and pulley block

Chevalet SA, treuil 4 incl. câble et bloc de poulies · Cavalletto SA, argano 4. incl., fune e set pulegge

Caballete SA, cabrestante 4 incl. cable y juego de poleas · SA-стойка, лебедка 4, включая канат и канатный блок

33 t

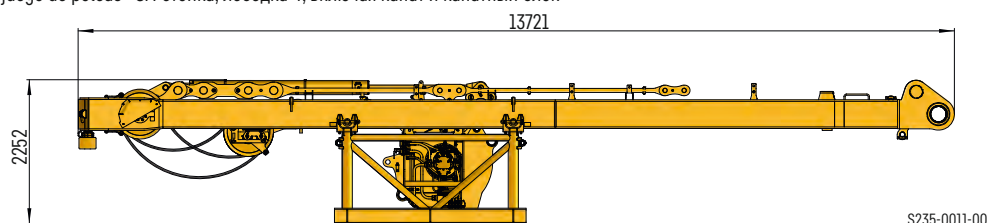

3,1 m Breite · width · largeur · larghezza · anchura · ширина

* + **0,9 t Transportablage** · transport support · t pour le support de transport · ripiano per trasporto · de superficie de transporte · транспортная опора грузоподъемностью

Standard Auslegersysteme

96 + 84

Standard boom system • Systèmes de flèche standards • Sistemi braccio standard
 Sistema estándar de plumas • Стандартные, стреловые системы

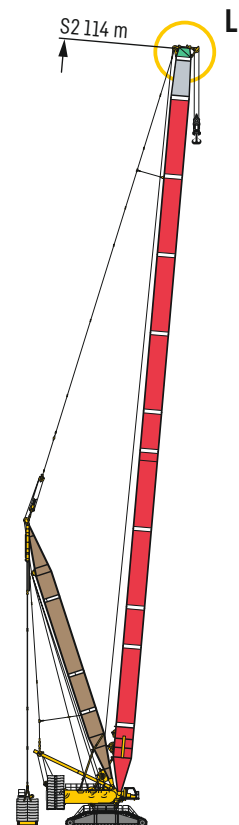
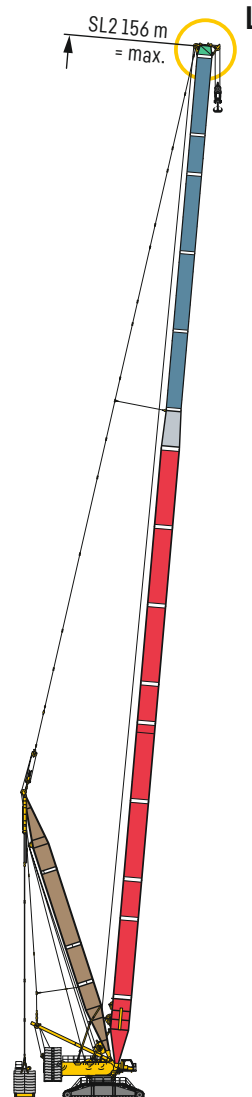
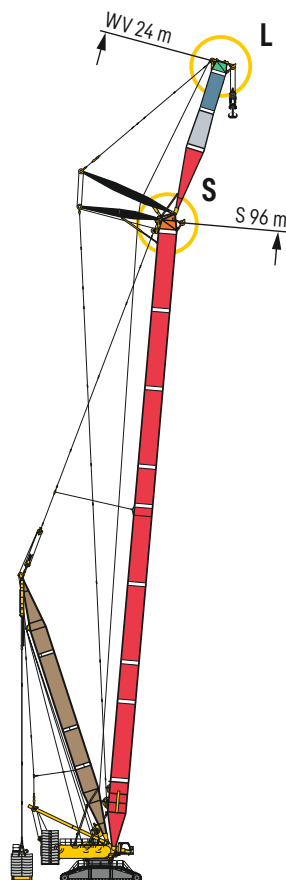
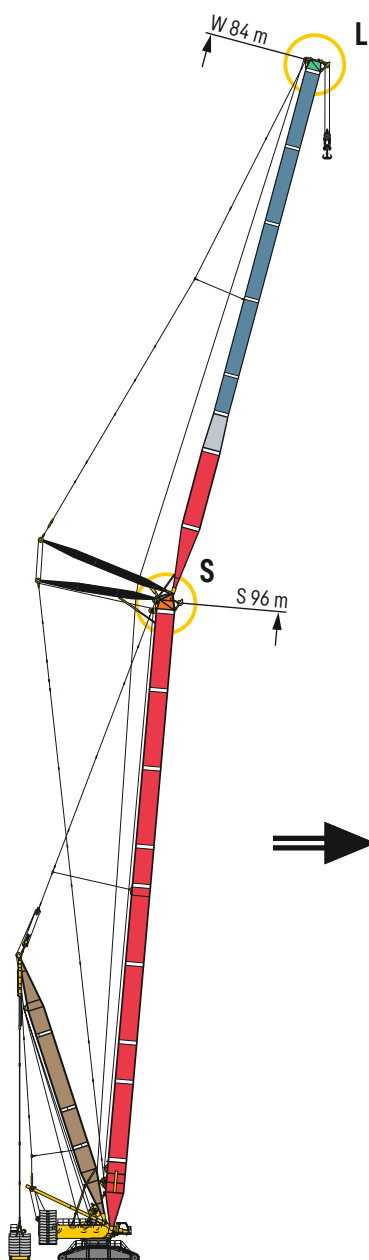
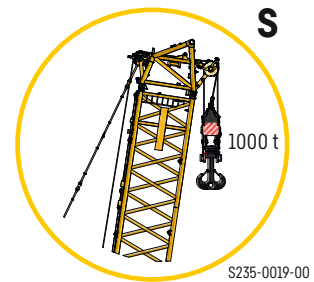
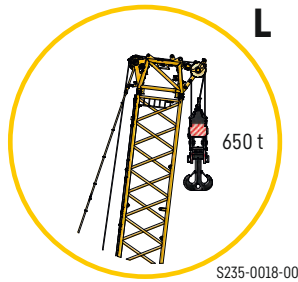
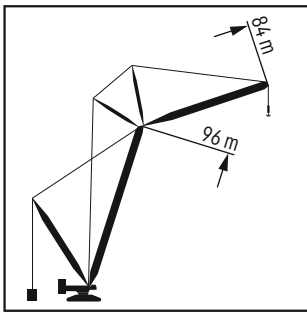

SDWB/BV/BW

S 42 m - 108 m
 W 18 m - 114 m
 D 36 m - 42 m

SDWVB/BV/BW

S 42 m - 108 m
 W 18 m - 24 m
 D 36 m - 42 m

SL2DB/BV/BW

SL2 42 m - 156 m
 D 36 m - 42 m

S2DB/BW

S2 42 m - 156 m
 D 36 m - 42 m

Standard Auslegersysteme

96 + 84

Standard boom system · Systèmes de flèche standards · Sistemi braccio standard
Sistema estándar de plumas · Стандартные, стреловые системы

S Hauptausleger, schwer
Main boom, heavy
Flèche principale, lourde
Braccio principale, per carichi pesanti
Pluma principal, pesada
Основная стрела, тяжелая

D Derrickauleger
Derrick
Flèche derrick
Braccio Derrick
Pluma Derrick
Деррик-стрела

B/B2 Schwebeballast
Suspended ballast
Lest suspendu
Zavorra sospesa
Contrapeso flotante
Подвесной противовес

S Hauptausleger, schwer/leicht
Main boom, heavy/light
Flèche principale, lourde/légère
Braccio principale,
per carichi pesanti/leggeri
Pluma principal, pesada / ligera
Основная стрела, тяжелая/ле"кая

W Wipbare Gitterspitze, schwer
Luffing fly jib, heavy
Flèche, lourde
Falcone tralicciato a volata
variabile, per carichi pesanti
Pluma abatible, pesada
Качающийся решетчатый
удлинитель, тяжелый

P PowerBoom

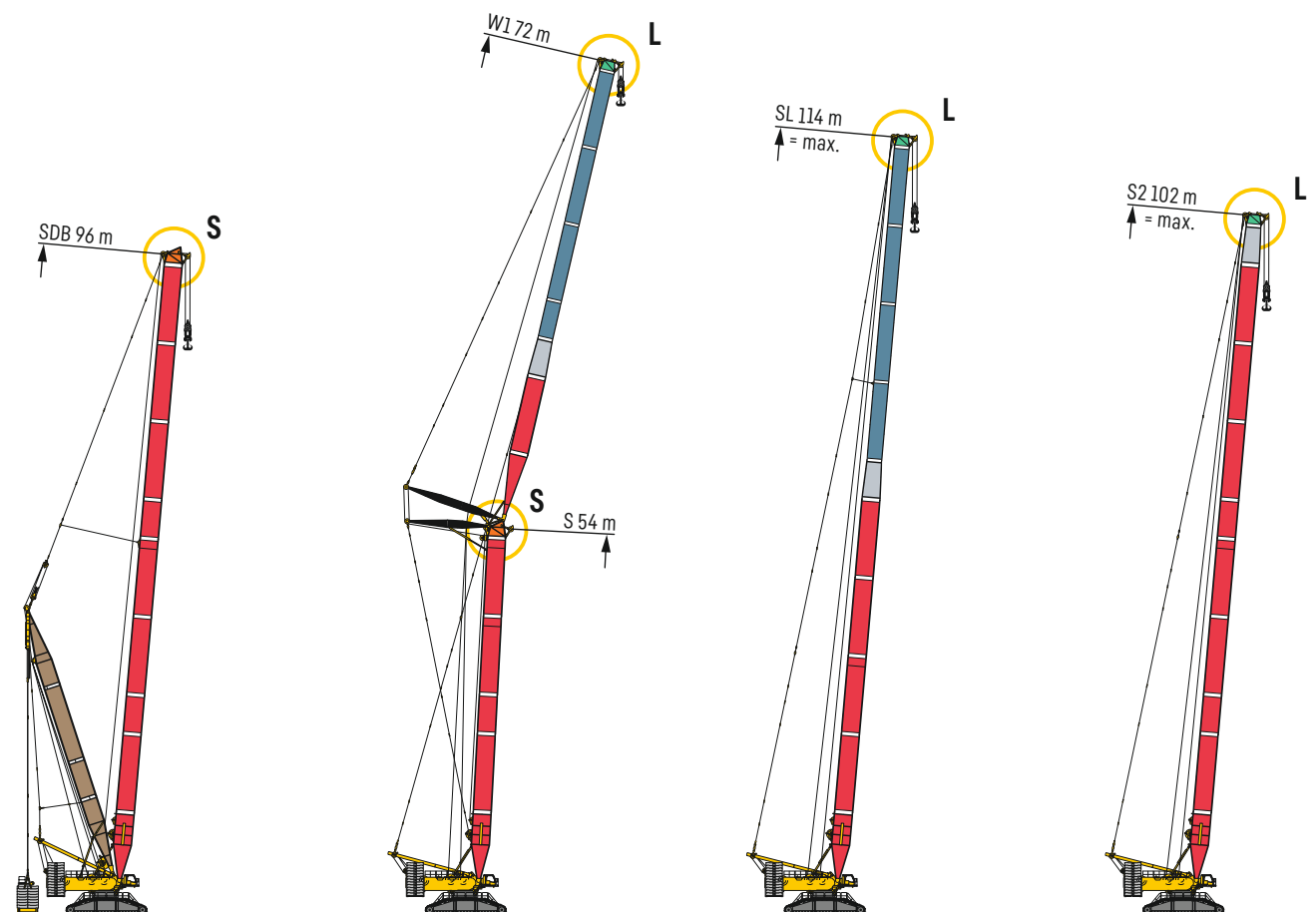

SDB/BV/BW
S 42 m - 108 m
D 42 m

SW1
S 42 m - 60 m
W1 18 m - 84 m

SL
SL 18 m - 114 m

S2
S2 18 m - 102 m

S2799.01

Erweiterte Auslegersysteme

108 + 114

Extended boom system • Systèmes de flèche étendus • Sistemi braccio lunghi
 Amplio sistema de plumas • Удлиненные стреловые системы

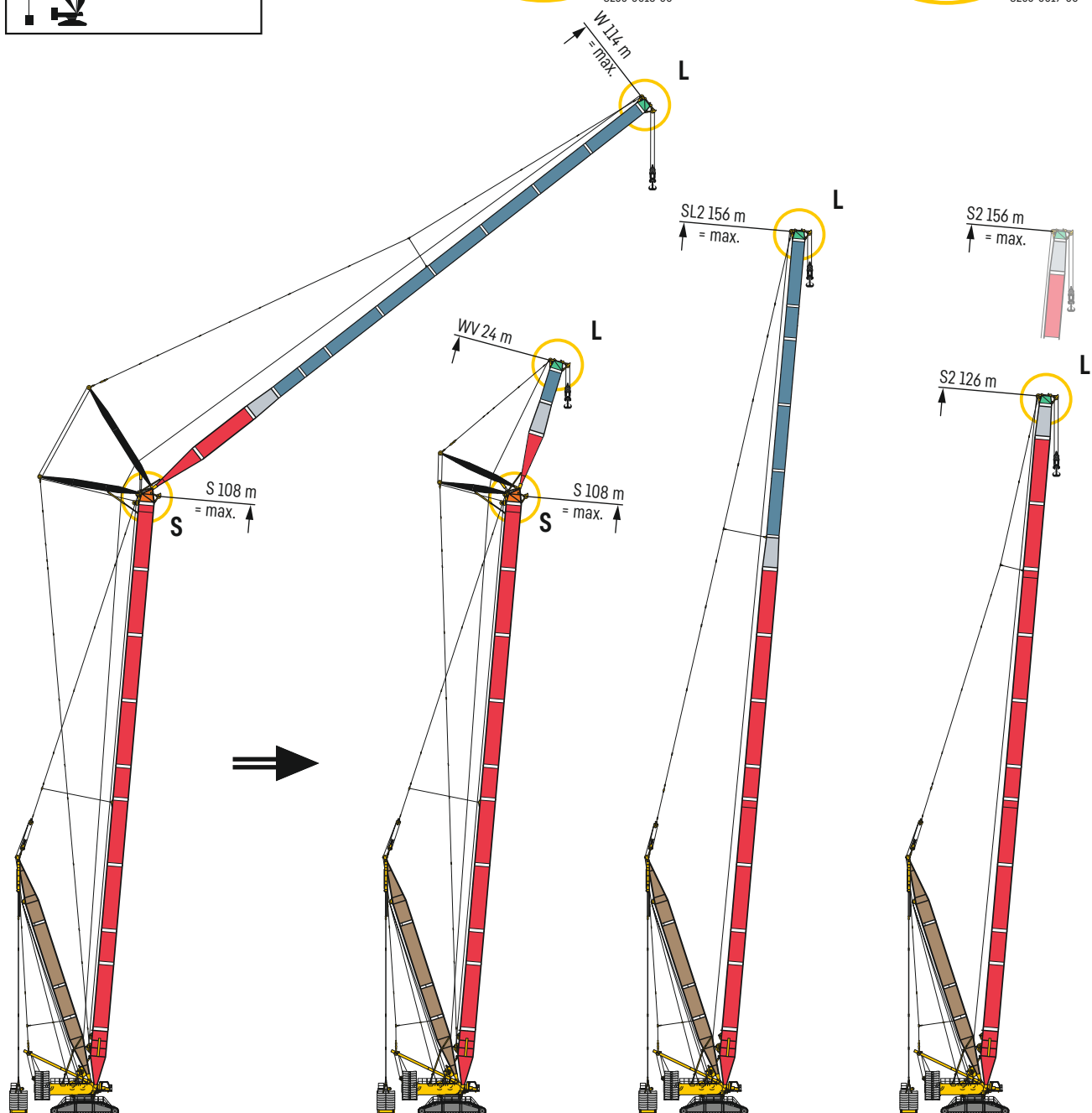
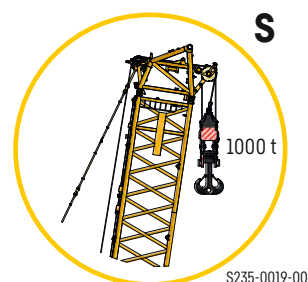
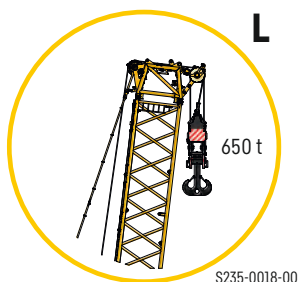
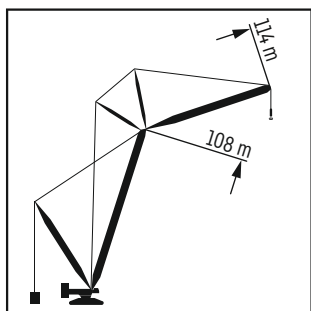

SDWB/BV/BW

S 42 m - 108 m
 W 18 m - 114 m
 D 36 m - 42 m

SDWVB/BV/BW

S 42 m - 108 m
 W 18 m - 24 m
 D 36 m - 42 m

SL2DB/BV/BW

SL2 42 m - 156 m
 D 36 m - 42 m

S2DB/BW

S2 42 m - 156 m
 D 36 m - 42 m

Erweiterte Auslegersysteme

108 + 114

Extended boom system • Systèmes de flèche étendus • Sistemi braccio lunghi
 Amplio sistema de plumas • Удлиненные стреловые системы

S 9 t - 17 t

L 7 t - 9 t

S + L 16 t - 26 t

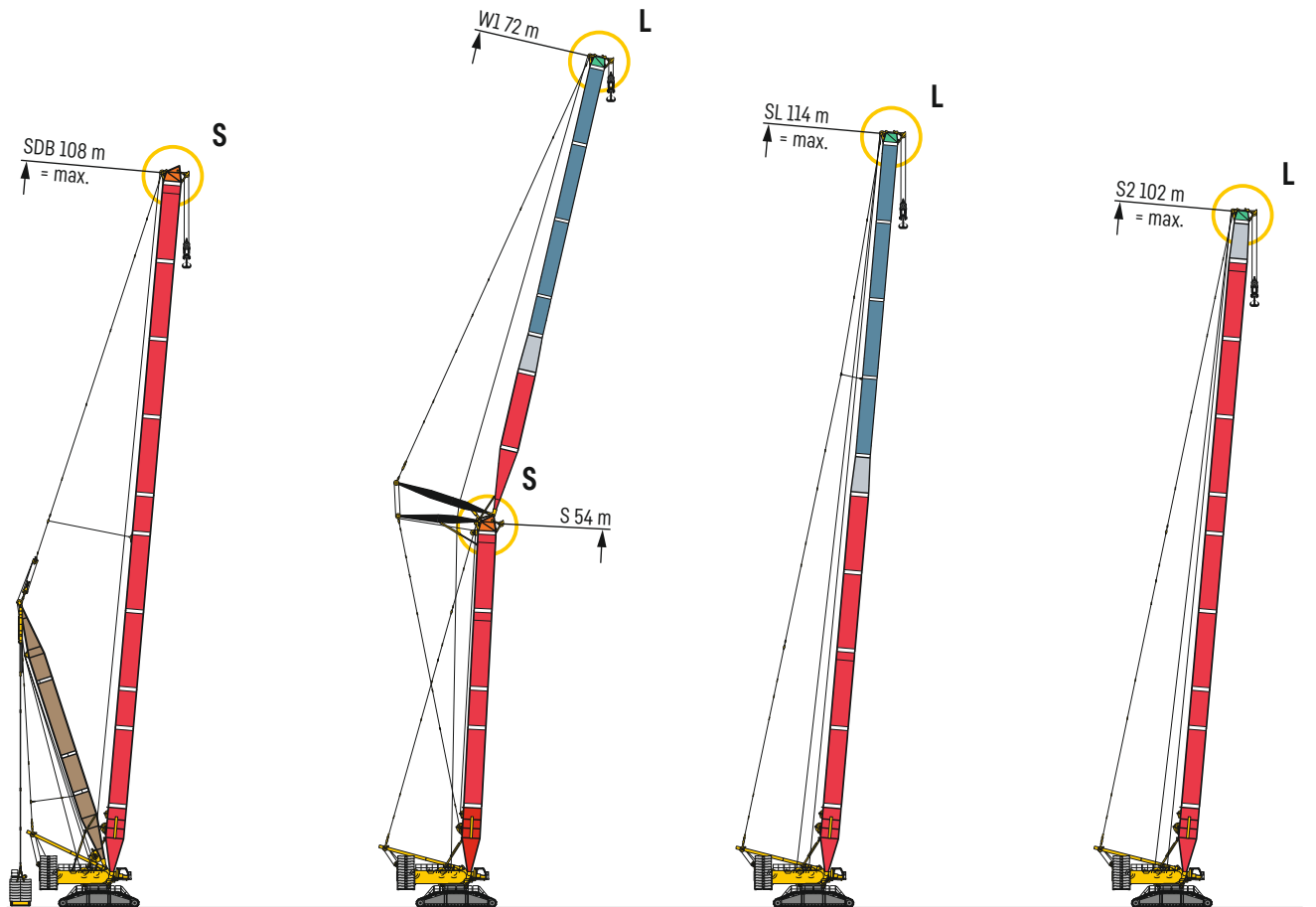
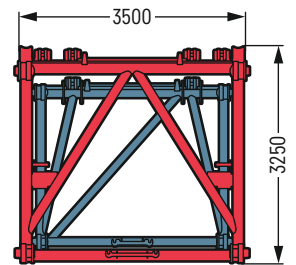
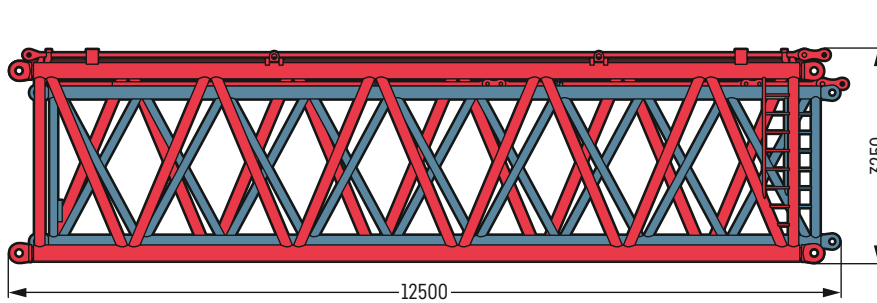

SDB/BV/BW
 S 42 m - 108 m
 D 36 m - 42 m

SW1
 S 42 m - 60 m
 W1 18 m - 84 m

SL
 SL 18 m - 114 m

S2
 S2 18 m - 102 m

S2800.01

PowerBoom Auslegersysteme

PowerBoom system • Systèmes de flèche PowerBoom • Sistemi braccio con PowerBoom
 Sistemas de plumas PowerBoom • Стреловые системы с мощной сдвоенной стрелой „P“

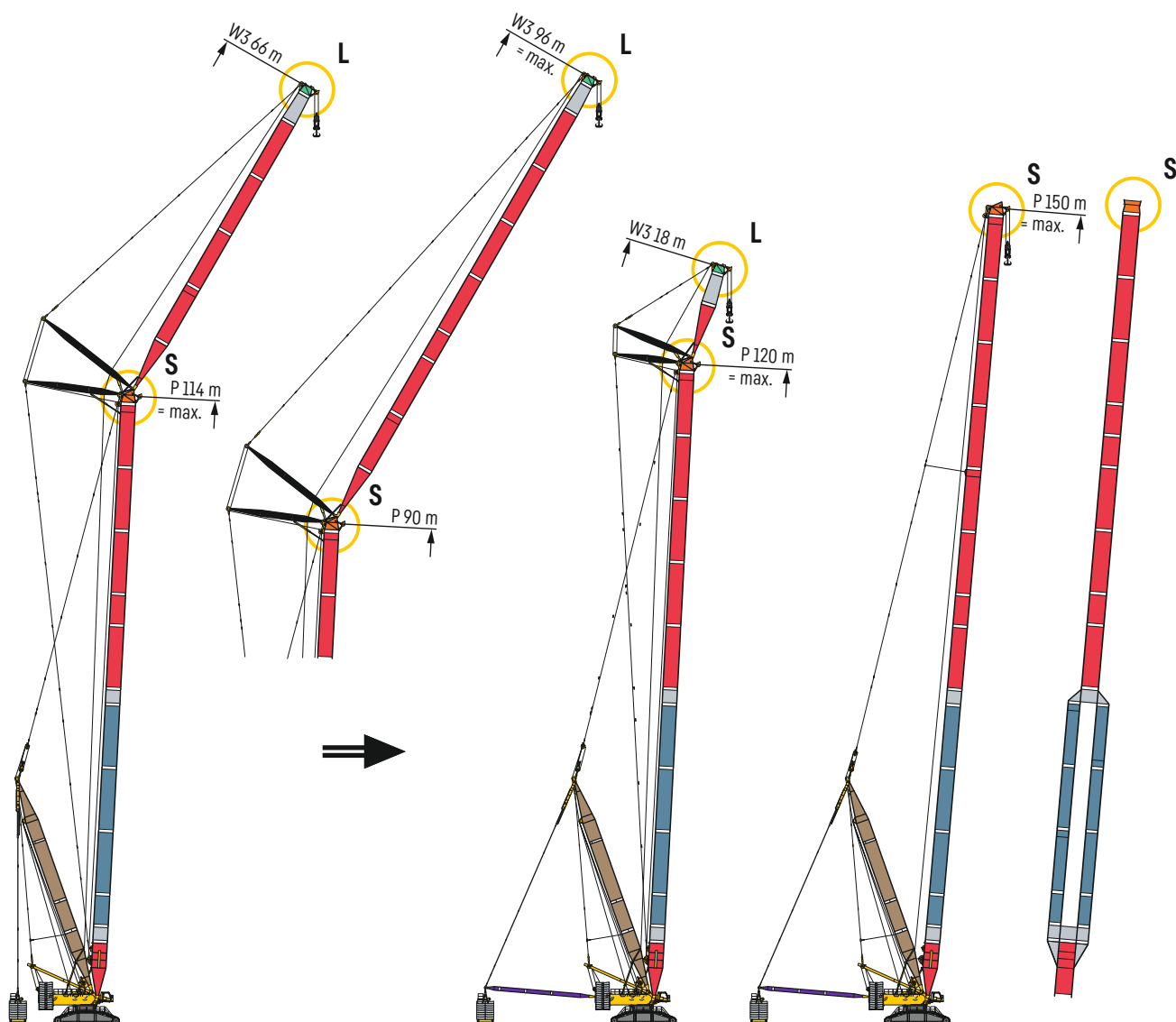
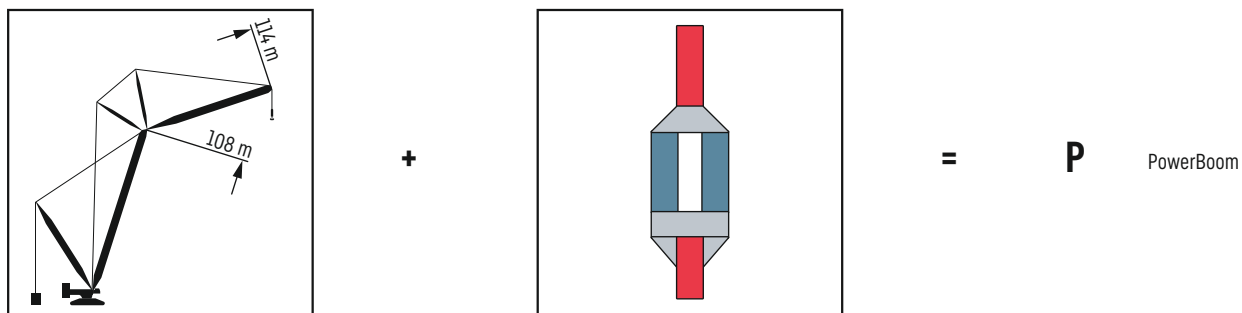

PDW3B/BW

P 48 m - 120 m
 W3 18 m - 96 m
 D 36 m - 42 m

PDWV3B/BW

P 48 m - 120 m
 W3 18 m - 24 m
 D 36 m - 42 m

PDB/BW

P 48 m - 150 m
 D 36 m - 42 m

S2801.01

PowerBoom Auslegersysteme

PowerBoom system • Systèmes de flèche PowerBoom • Sistemi braccio con PowerBoom
Sistemas de plumas PowerBoom • Стреловые системы с мощной сдвоенной стрелой „P“

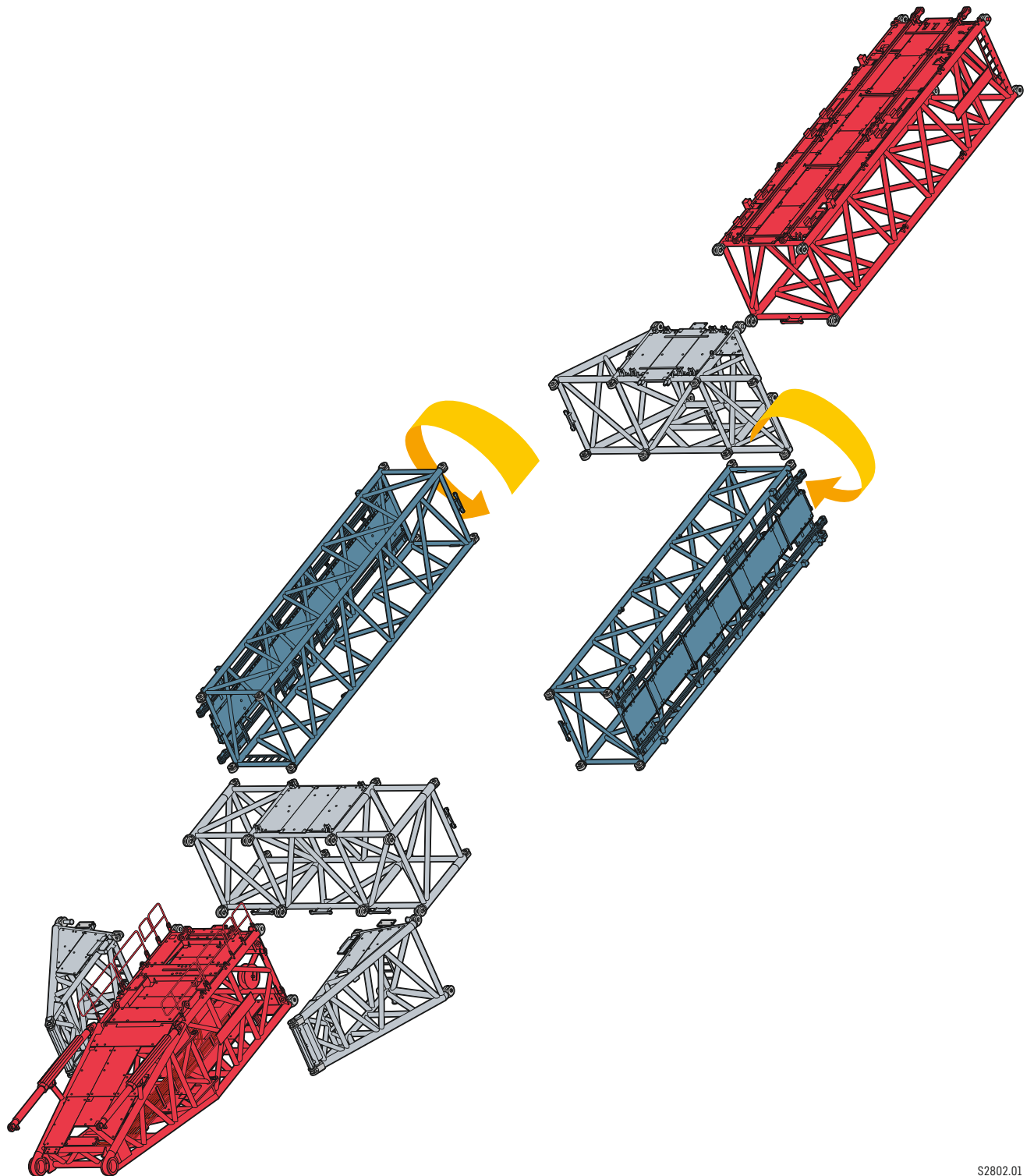

S2802.01

Auslegersysteme – Windkraft

Boom system – Wind power · Systèmes de flèche – L'énergie éolienne · Sistemi braccio – L'energia eolica
 Sistema de plumas – energía eólica · Стреловые системы – ветроэнергетики

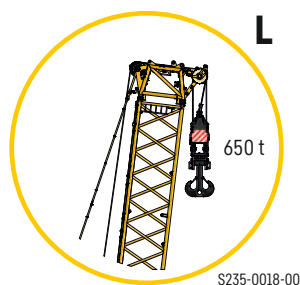

S235-0018-00

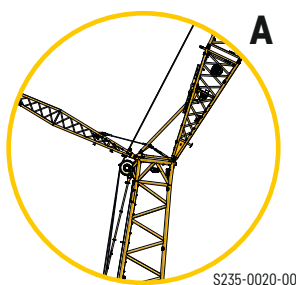

S235-0020-00

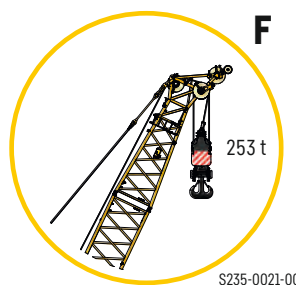

S235-0021-00

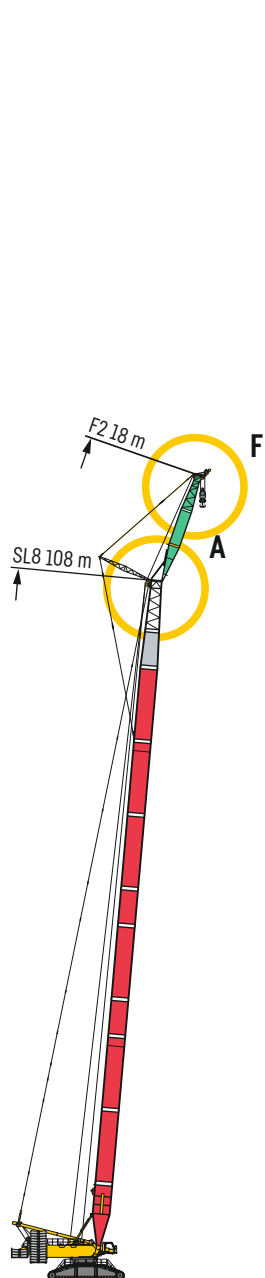

SL8F2
 SL8 84 m - 108 m
 F2 12 m - 36 m

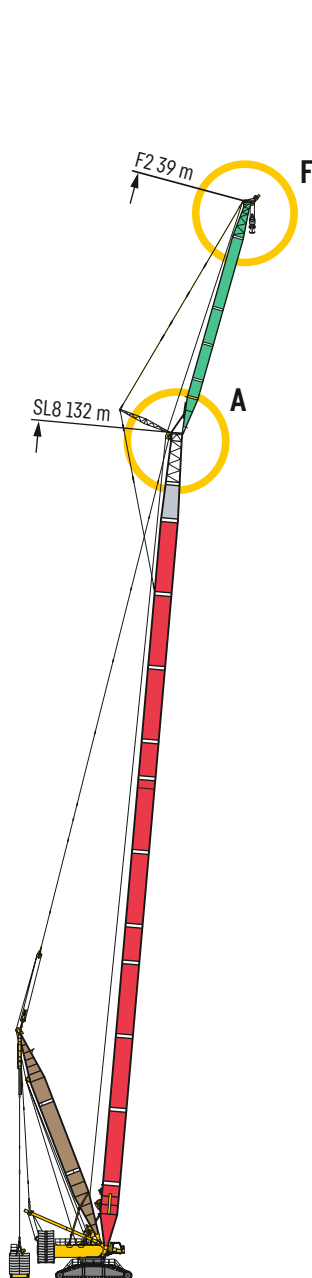

SL8DF2B
 SL8 102 m - 132 m
 F2 12 m - 39 m
 D 36 m

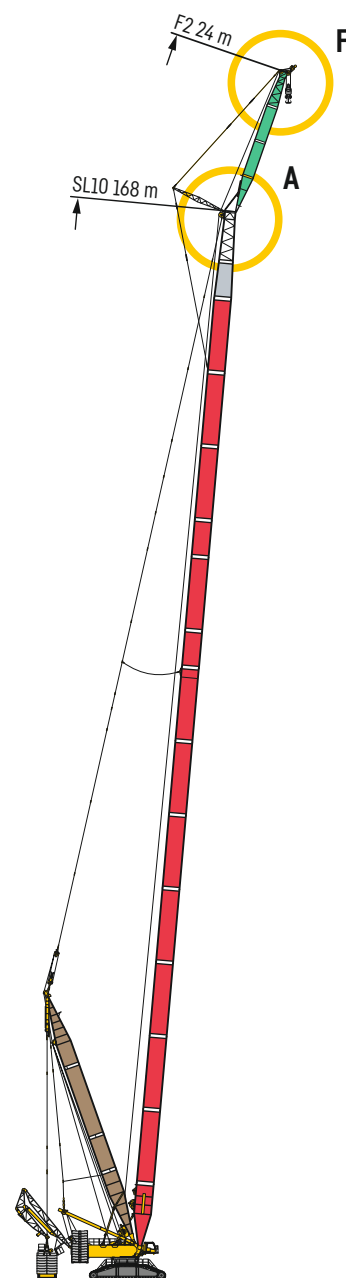

SL10DF2B/BV
 SL10 72 m - 168 m
 F2 12 m - 39 m
 D 42 m

Auslegersysteme – Windkraft

Boom system – Wind power • Systèmes de flèche – L'énergie éolienne • Sistemi braccio – L'energia eolica
Sistema de plumas – energía eólica • Стреловые системы – ветроэнергетики

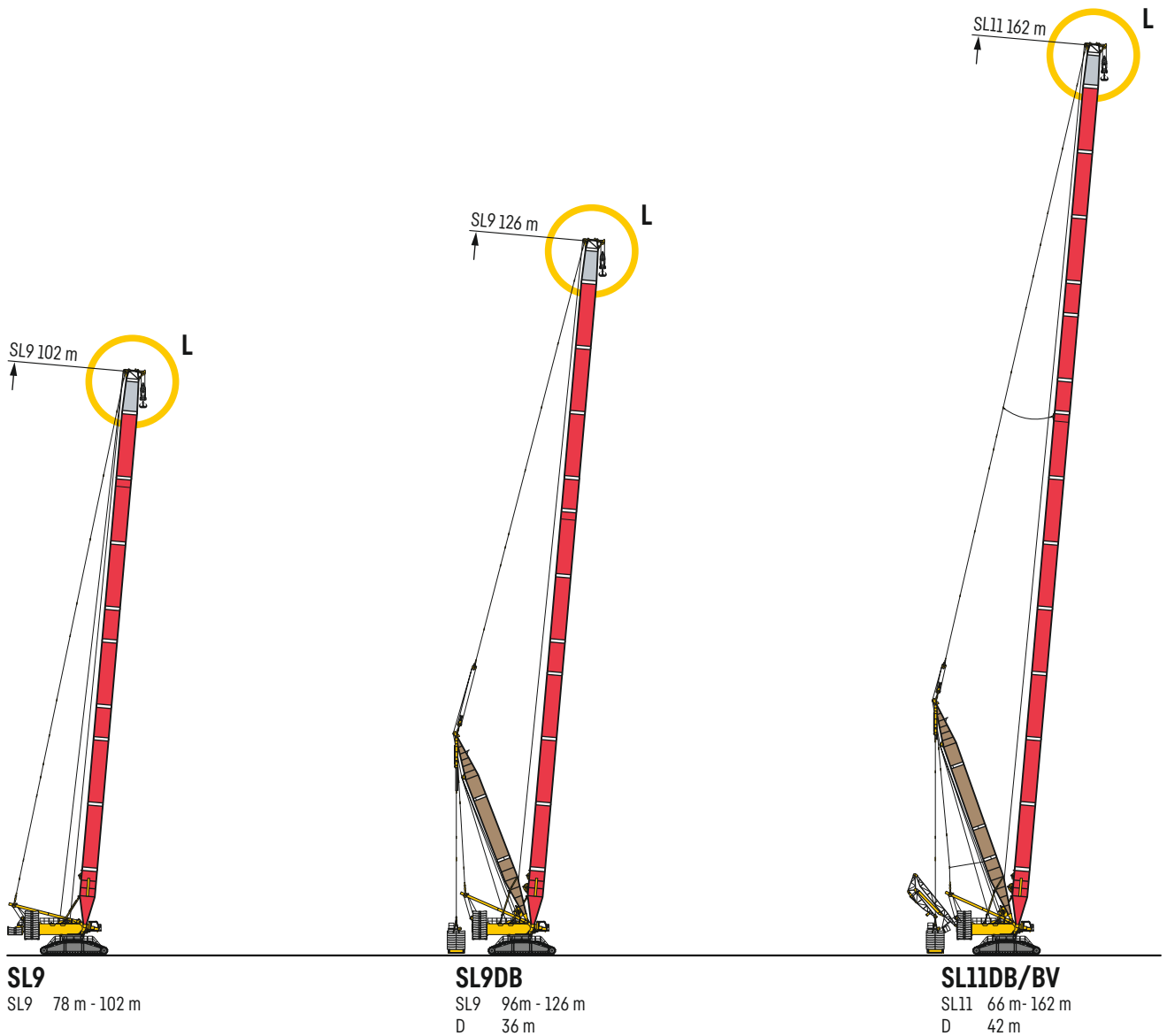

S3414

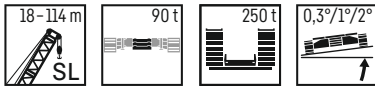

		SL 18 - 114 m																
		18 m	24 m	30 m	36 m	42 m	48 m	54 m	60 m	66 m	72 m	78 m	84 m	90 m	96 m	102 m	108 m	114 m
6	0.3	650	650															
	1	650																
7	0.3	650	650	650	646													
	1	650	650															
8	0.3	650	650	650	648	636	632											
	1	637	625	605														
9	0.3	600	577															
	1	628	624	618	616	619	588	556										
10	0.3	592	577	562	548	507												
	1	555	527	489														
11	0.3	570	568	568	567	548	519	492	467	445								
	1	539	526	515	488	454	423											
12	0.3	509	484	460	421													
	1	518	517	517	512	486	463	440	419	400	384	250						
14	0.3	493	482	471	439	410	384	360										
	1	469	443	417	383	353												
16	0.3	475	473	475	458	437	416	397	380	363	350	334	322					
	1	450	441	425	398	373	351	330										
18	0.3	414	392	375	351	325	301											
	1	382	385	387	377	361	346	331	318	305	294	283	273	265	255	249	231	
20	0.3	356	349	343	334	316	298	281	266	252	240	228						
	1	332	318	306	294	279	260	242	227									
22	0.3	308	311	314	314	307	295	283	272	262	253	243	236	229	221	216	209	199
	1	292	287	284	278	271	258	244	232	220	210	199	191	183				
24	0.3	277	266	258	248	238	228	213	200	187	175							
	1	256	260	263	263	261	255	245	236	227	221	212	206	200	194	190	183	179
26	0.3	228	222	214	206	198	189	178	167	159	145	141	135	129	123	117	111	103
	1	222	225	225	224	222	216	208	200	194	187	181	177	171	168	162	159	
28	0.3	210	209	205	201	196	190	182	172	166	157	151	145					
	1	199	194	188	181	174	167	160	150	143	134	115	88,8					
30	0.3	192	195	195	194	193	191	185	178	173	166	161	157	152	150	145	142	
	1	184	183	180	176	172	168	163	155	149	141	135	131					
32	0.3	176	172	167	161	155	149	143	136	129	121	113	88,8					
	1	172	172	171	170	170	167	165	159	155	149	144	141	137	135	130	127	
34	0.3	163	160	157	153	149	146	139	134	127	122	118	118					
	1	155	150	144	139	133	128	123	117	110	104	104	88,8					
36	0.3	154	154	152	150	149	147	143	139	134	130	127	123	121	117	114		
	1	146	144	141	137	133	130	127	122	115	111	107	107	107	107	107	107	107
38	0.3	140	135	130	125	120	116	111	107	100	94,8							
	1	138	138	137	135	133	131	129	126	121	117	115	111	111	111	111	111	111
40	0.3	130	127	124	120	117	114	111	107	101	97,9	91,4	86,5	82,7	82,7	82,7	82,7	82,7
	1	123	119	114	109	105	101	97,9	91,4	86,5	82,7	82,7	82,7	82,7	82,7	82,7	82,7	82,7
42	0.3	125	124	122	120	118	116	115	110	106	104	104	104	104	104	104	104	104
	1	119	116	113	109	106	103	101	99,9	99,9	99,9	99,9	99,9	99,9	99,9	99,9	99,9	99,9
44	0.3	113	109	104	99,6	95,7	91,7	89,3	83,8	79,1	75,6	75,6	75,6	75,6	75,6	75,6	75,6	75,6
	1	114	113	111	108	107	105	104	100	96,7	94,5	91,5	88,4	88,4	88,4	88,4	88,4	88,4
46	0.3	109	106	103	99,4	96,7	93,7	92,4	87,9	83,7	80,8	80,8	80,8	80,8	80,8	80,8	80,8	80,8
	1	104	100	95,6	91,3	87,6	83,8	81,6	77	72,5	69,3	69,3	69,3	69,3	69,3	69,3	69,3	69,3
48	0.3	103	101	98,8	97,2	95,3	94,9	91,5	88,4	85,5	82,7	82,7	82,7	82,7	82,7	82,7	82,7	82,7
	1	97,5	94,3	91,1	88,4	85,5	84,2	80,5	76,8	74,7	70,4	66,6	63,6	63,6	63,6	63,6	63,6	63,6
50	0.3	92,5	88,3	84	80,5	76,8	74,7	70,4	66,6	63,6	63,6	63,6	63,6	63,6	63,6	63,6	63,6	63,6
	1	94,6	92,7	90,4	88,8	86,8	86,3	83,7	80,8	78,9	78,9	78,9	78,9	78,9	78,9	78,9	78,9	78,9
52	0.3	90,1	87	83,8	81,1	78,2	77	73,8	70,4	68	68	68	68	68	68	68	68	68
	1	85,9	81,8	77,6	74,3	70,6	68,4	64,3	61,2	58,4	58,4	58,4	58,4	58,4	58,4	58,4	58,4	58,4
54	0.3	87,3	85,3	83	81,4	79,3	78,8	76,7	73,8	72,1	72,1	72,1	72,1	72,1	72,1	72,1	72,1	72,1
	1	80,5	77,2	74,7	71,7	68,6	64,8	62,5	59	56,2	53,6	53,6	53,6	53,6	53,6	53,6	53,6	53,6
56	0.3	78,8	76,5	74,8	72,7	72	72	70,2	67,8	66	66	66	66	66	66	66	66	66
	1	74,7	71,5	68,9	65,8	64,5	64,5	61,4	59,3	57,2	57,2	57,2	57,2	57,2	57,2	57,2	57,2	57,2
58	0.3	70,9	66,9	63,5	59,8	57,7	57,7	54,3	51,7	49,2	49,2	49,2	49,2	49,2	49,2	49,2	49,2	49,2
	1	65,6	63,7	61,2	60,4	60,4	60,4	58,2	57	55,6	55,6	55,6	55,6	55,6	55,6	55,6	55,6	55,6
60	0.3	61,8	59,2	56,1	54,7	54,7	54,7	51,9	49,8	48,3	48,3	48,3	48,3	48,3	48,3	48,3	48,3	48,3
	1	58,3	55,1	51,4	49,4	49,4	49,4	45,2	42,4	41,1	41,1	41,1	41,1	41,1	41,1	41,1	41,1	41,1
62	0.3	56,8	54,8	52,3	51,5	51,5	51,5	49,2	47,9	46,9	46,9	46,9	46,9	46,9	46,9	46,9	46,9	46,9
	1	51,3	48	46	43	43	43	40,8	40,8	40,2	40,2	40,2	40,2	40,2	40,2	40,2	40,2	40,2
64	0.3	48,1	42,9	41,1	41,1	41,1	41,1	38	35,9	34,7	34,7	34,7	34,7	34,7	34,7	34,7	34,7	34,7
	1	47,5	43,7	42,5	40,3	40,3	40,3	39,1	38,6	38,6	38,6	38,6	38,6	38,6	38,6	38,6	38,6	38,6
66	0.3	43,9	40,3	38,9	36,2	36,2	36,2	34,3	33	32,5	32,5	32,5	32,5	32,5	32,5	32,5	32,5	32,5
	1	37,4	35,6	35,6	34,3	34,3	34,3	33,7	33,7	33,7	33,7	33,7	33,7	33,7	33,7	33,7	33,7	33,7
68	0.3	32,8	31,1	31,1	31,1	31,1	31,1	31,1	31,1	31,1	31,1	31,1	31,1	31,1	31,1	31,1	31,1	31,1
	1	31,1	31,1	31,1	31,1	31,1	31,1	31,1	31,1	31,1	31,1	31,1	31,1	31,1	31,1	31,1	31,1	31,1
70	0.3	31,6	29,2	29,2	29,2	29,2	29,2	29,2	29,2	29,2	29,2	29,2	29,2	29,2	29,2	29,2	29,2	29,2
	1	29,2	26,3	24,4	24,4	24,4	24,4	24,4	24,4	24,4	24,4	24,4	24,4	24,4	24,4	24,4	24,4	24,4
72	0.3	27,2	27,2	27,2	27,2	27,2	27,2	27,2	27,2	27,2	27,2	27,2	27,2	27,2	27,2	27,2	27,2	27,2
	1	26,9	23,3	20,8	20,8	20,8	20,8	20,8	20,8	20,8	20,8	20,8	20,8	20,8	20,8	20,8	20,8	20,8
74	0.3	24,4	22,9	22,9	22,9	22,9	22,9	22,9	22,9	22,9	22,9	22,9	22,9	22,9	22,9	22,9	22,9	22,9
	1	21,6	19,8	18,9	18,9	18,9	18,9	18,9	18,9	18,9	18,9	18,9	18,9	18,9	18,9	18,9	18,9	18,9
76	0.3	20,1	20,1	20,1	20,1	20,1	20,1	20,1	20,1	20,1	20,1	20,1	20,1	20,1	20,1	20,1	20,1	20,1
	1	18,6	16,3	15,4	15,4	15,4	15,4	15,4	15,4	15,4	15,4	15,4	15,4	15,4	15,4	15,4	15,4	15,4
78	0.3	15	13	13	13	13	13	13	13	13	13	13	13	13	13	13	13	13
	1	14,1	12,9	12,9	12,9	12,9	12,9	12,9	12,9	12,9	12,9	12,9	12,9	12,9	12,9	12,9	12,9	12,9
80	0.3	11,1	9,7	9,7	9,7	9,7	9,7	9,7	9,7	9,7	9,7	9,7	9,7	9,7	9,7	9,7	9,7	9,7
	1	9,1	6,7	6,7	6,7	6,7	6,7	6,7	6,7	6,7	6,7	6,7	6,7	6,7	6,7	6,7	6,7	6,7

Hubhöhen

SL

Lifting heights • Hauteurs de levage • Altezze di sollevamento • Alturas de elevación • Высота подъема

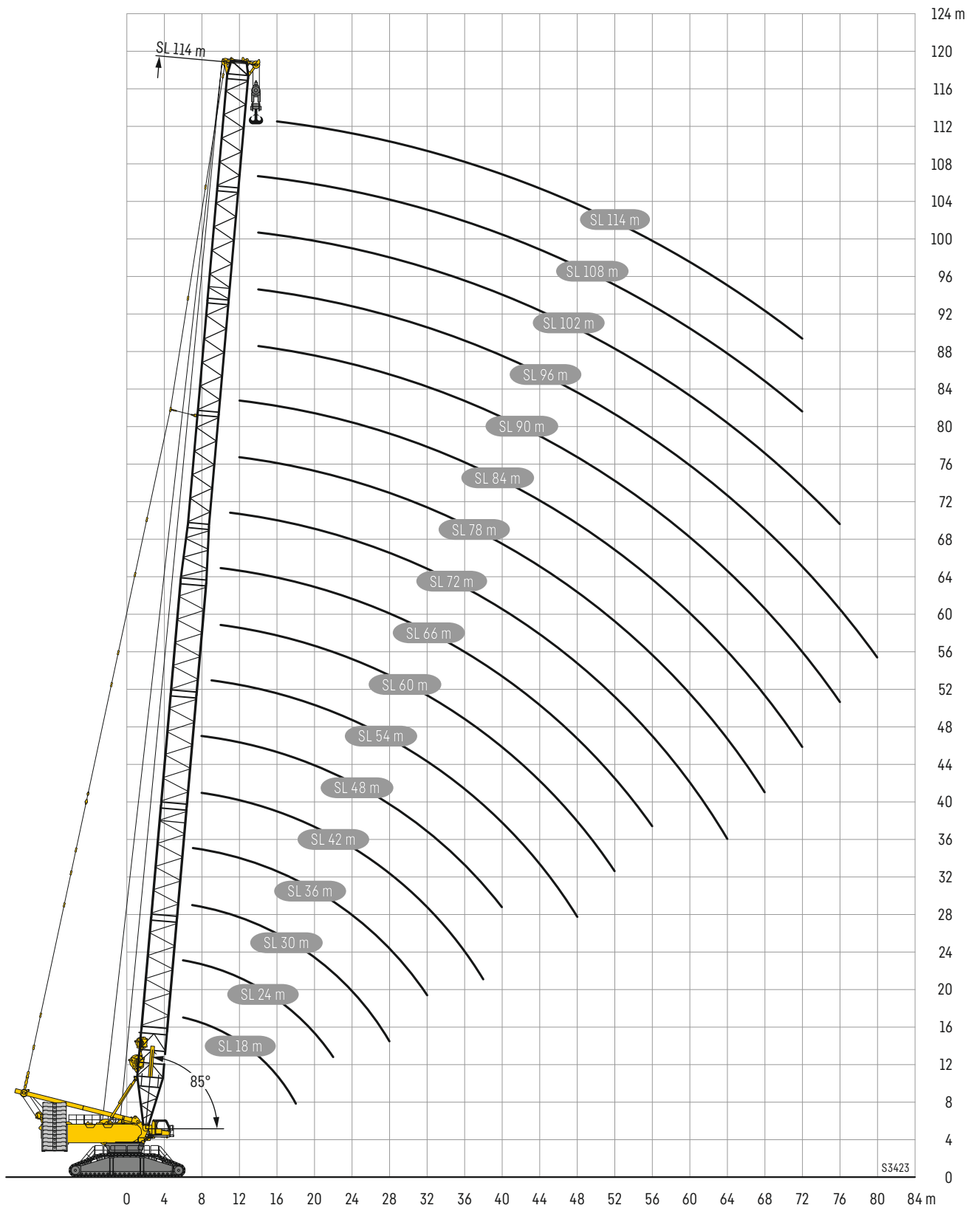

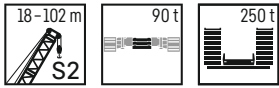

m	S2 18 - 102 m															m	
	18 m	24 m	30 m	36 m	42 m	48 m	54 m	60 m	66 m	72 m	78 m	84 m	90 m	96 m	102 m		
6	650	650														6	
7	650	650	650	650												7	
8	650	650	650	648	639	647										8	
9	628	624	616	612	614	584	553									9	
10	570	568	565	562	543	514	488	462	441							10	
11	518	517	514	508	482	458	436	415	396	379	321					11	
12	475	473	474	454	432	411	393	375	359	344	328	316				12	
14	382	385	385	373	356	341	327	313	301	289	277	266	256	245	238	14	
16	308	311	312	311	302	289	278	267	257	247	236	229	220	211	205	16	
18	256	260	260	260	258	250	241	231	223	214	205	198	191	183	178	18	
20		222	222	221	220	218	211	202	195	188	180	174	168	160	156	20	
22		192	193	192	190	189	187	179	173	166	159	154	148	141	138	22	
24			170	169	167	165	164	159	154	148	141	137	131	125	122	24	
26			151	150	148	146	145	142	138	132	126	122	117	111	109	26	
28			135	134	132	131	129	127	125	119	113	109	105	99,5	97,1	28	
30				121	119	117	116	113	113	108	102	98,4	94,2	88,9	86,8	30	
32				110	108	106	105	102	101	97,8	92,5	88,7	84,8	79,7	77,7	32	
34					98,6	96,4	94,8	92,5	91,5	88,9	83,8	80,4	76,4	71,5	69,7	34	
36					90,2	88,1	86,4	84	82,9	80,8	75,9	72,7	69,1	64,1	62,5	36	
38					82,8	80,7	78,9	76,6	75,4	73,3	68,9	65,7	62,3	57,7	56	38	
40						74,2	72,4	69,9	68,4	65,9	62,6	59,5	56,2	51,6	50,3	40	
44							61,4	58,7	57,1	54,8	51,8	48,8	45,7	41,3	40	44	
48								52,4	49,8	47,7	45,6	41,6	39,8	36,8	32,5	31,3	48
52									41	39,3	37	34,4	32,3	29,4	25,1	23,9	52
56										33,4	30,8	28	25,9	23	18,8	17,7	56
60											25,1	22,2	20,3	17,5	13,3	12,2	60
64												20,2	17,3	15,3	12,7		64
68													13	10,9	8,5		68
72														7,1			72

Hubhöhen

S2

Lifting heights • Hauteurs de levage • Altezze di sollevamento • Alturas de elevación • Высота подъема

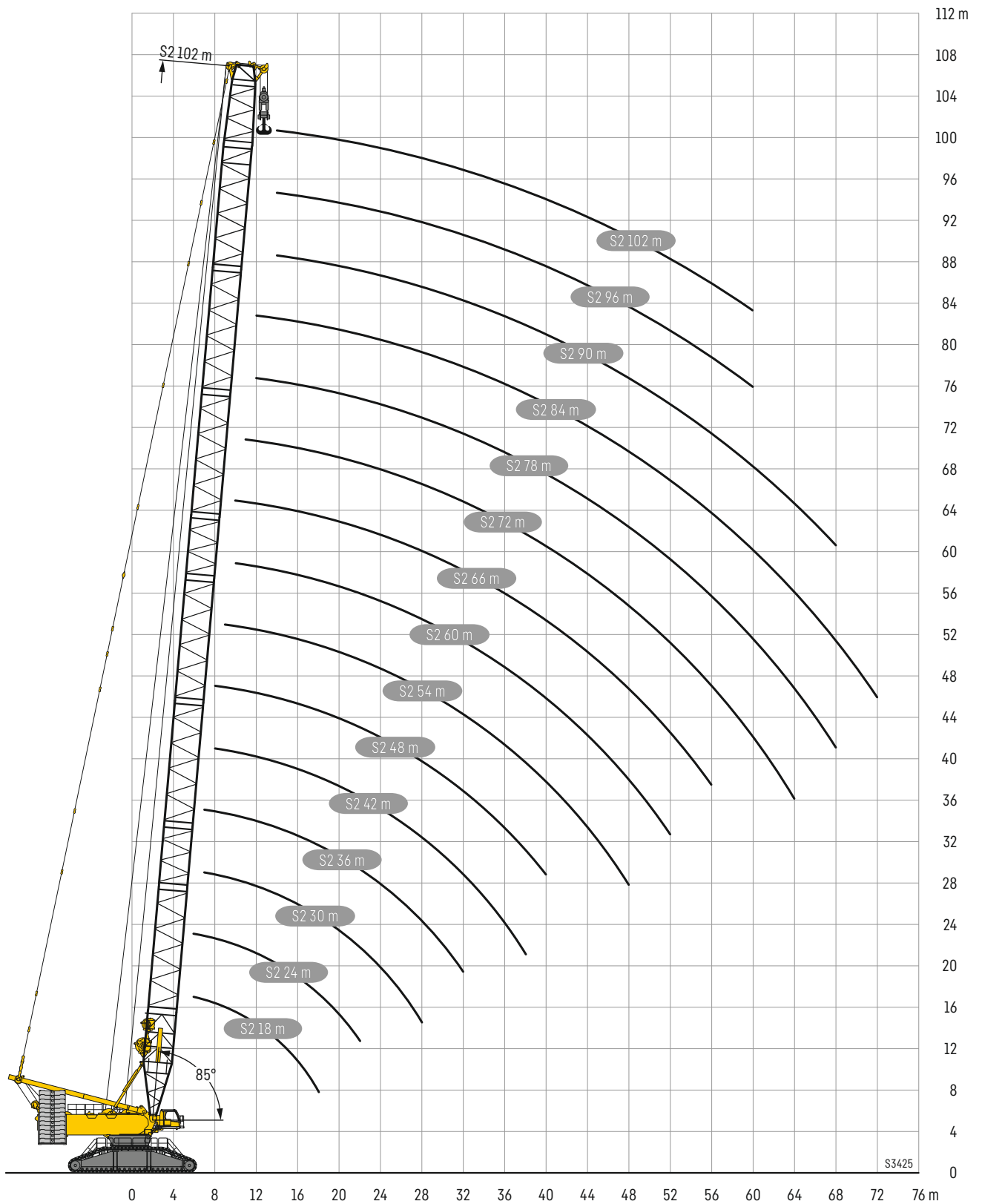

SDB/SDBV/SDBW

S 42 - 108

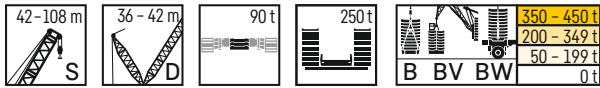

		S 42 - 108 m											
		42 m	48 m	54 m	60 m	66 m	72 m	78 m	84 m	90 m	96 m	102 m	108 m
		D 36 m				D 42 m							
m													
	9	B	998	1000									
BV													
BW		1000	1000										
10	B	965	968	939									
	BV												
	BW	1000	1000	985									
11	B	946	926	901	869	813							
	BV												
	BW	1000	992	958	919	840							
12	B	905	886	865	837	792	721						
	BV												
	BW	980	957	928	895	836	750						
14	B	809	802	787	777	743	703	639	573	511			
	BV												
	BW	912	893	869	842	805	748	665	591	524			
16	B	708	710	703	696	693	664	624	565	510	458	409	366
	BV					754	716	664	592	524	467	414	
	BW	835	833	812	795	764	724	659	592	526	468	415	370
18	B	619	633	624	623	642	621	595	561	504	453	406	366
	BV					710	680	645	593	525	469	416	371
	BW	760	759	754	738	725	692	654	594	527	469	417	372
20	B	542	564	563	559	585	576	559	535	497	449	403	361
	BV					668	644	616	584	527	470	417	372
	BW	687	687	681	676	687	660	628	584	527	469	418	372
22	B	479	501	510	506	532	526	519	506	481	441	396	361
	BV					627	611	588	562	525	471	418	371
	BW	609	624	619	614	643	628	601	571	527	466	417	371
24	B	426	444	462	463	486	482	475	471	459	433	390	351
	BV					571	573	560	539	512	471	417	369
	BW	542	569	566	563	591	589	576	552	520	466	416	368
26	B	382	399	416	423	447	442	439	434	428	413	382	346
	BV					536	524	526	516	494	468	414	365
	BW	486	519	519	518	558	546	541	530	504	464	414	366
28	B	344	359	376	387	413	410	405	403	397	389	368	338
	BV					509	496	484	485	474	453	410	359
	BW	437	469	481	478	528	518	504	499	484	459	412	364
30	B	308	330	340	353	383	380	377	373	371	365	350	326
	BV					483	473	461	449	447	436	404	351
	BW	392	426	443	445	495	490	479	467	459	445	409	364
32	B	279	299	312	323	356	354	351	349	345	342	332	315
	BV					459	450	440	431	418	412	394	344
	BW	356	388	405	414	464	460	454	445	433	424	399	364
34	B	256	272	289	299	333	330	327	326	323	319	313	301
	BV					435	428	420	412	402	389	376	337
	BW	323	354	372	387	435	431	428	422	414	404	388	357
36	B	235	253	267	275	310	310	306	305	303	300	295	288
	BV					410	406	401	394	385	375	360	333
	BW	295	325	343	358	409	406	401	399	394	386	375	349
38	B	213	233	246	255	290	291	288	286	284	283	278	274
	BV					386	383	379	377	369	360	348	326
	BW	270	298	317	331	385	382	379	376	374	368	359	340
40	B		213	226	235	272	273	271	270	268	266	263	259
	BV					365	362	359	357	352	346	335	316
	BW		272	293	307	364	361	358	356	353	350	343	330
44	B			191	201	237	240	240	239	239	237	234	231
	BV					328	325	322	321	318	315	309	295
	BW			255	268	324	324	321	320	317	315	311	306
48	B			166	176	206	210	210	213	214	213	209	207
	BV					290	294	292	290	288	286	281	275
	BW			217	233	285	291	290	288	287	285	281	276

SDB/SDBV/SDBW

S 42 - 108

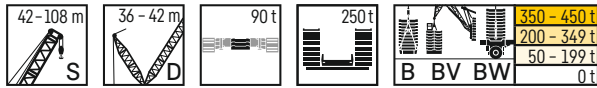

		S 42 - 108 m											
		42 m	48 m	54 m	60 m	66 m	72 m	78 m	84 m	90 m	96 m	102 m	108 m
m	B BV BW	D 36 m				D 42 m							
		52	B				150	183	188	189	190	193	191
	BV					255	262	264	264	261	259	256	253
	BW				200	251	259	260	261	259	259	254	251
56	B					160	166	166	168	173	172	171	169
	BV					227	236	241	240	239	237	233	231
	BW					224	232	235	237	236	235	232	229
60	B						147	149	151	154	156	155	154
	BV						210	217	219	217	217	213	211
	BW						207	210	214	216	215	212	210
64	B						132	135	138	140	141	139	140
	BV						187	194	200	200	198	195	193
	BW						185	189	193	197	196	194	192
68	B							121	125	126	125	124	126
	BV							175	182	182	182	179	178
	BW							170	175	178	179	178	177
72	B								109	111	112	113	113
	BV								162	165	168	165	164
	BW								156	159	163	164	163
76	B									101	103	103	104
	BV									151	155	153	152
	BW									147	150	151	151
80	B										93,7	93,9	93,8
	BV										143	142	140
	BW										137	139	139
84	B										82,7	83	82,2
	BV										128	129	130
	BW										124	125	125
88	B											72,6	73,4
	BV											117	120
	BW											113	114
92	B												66,7
	BV												110
	BW												105

Hubhöhen

SDB/SDBV/SDBW

Lifting heights • Hauteurs de levage • Altezze di sollevamento • Alturas de elevación • Высота подъема

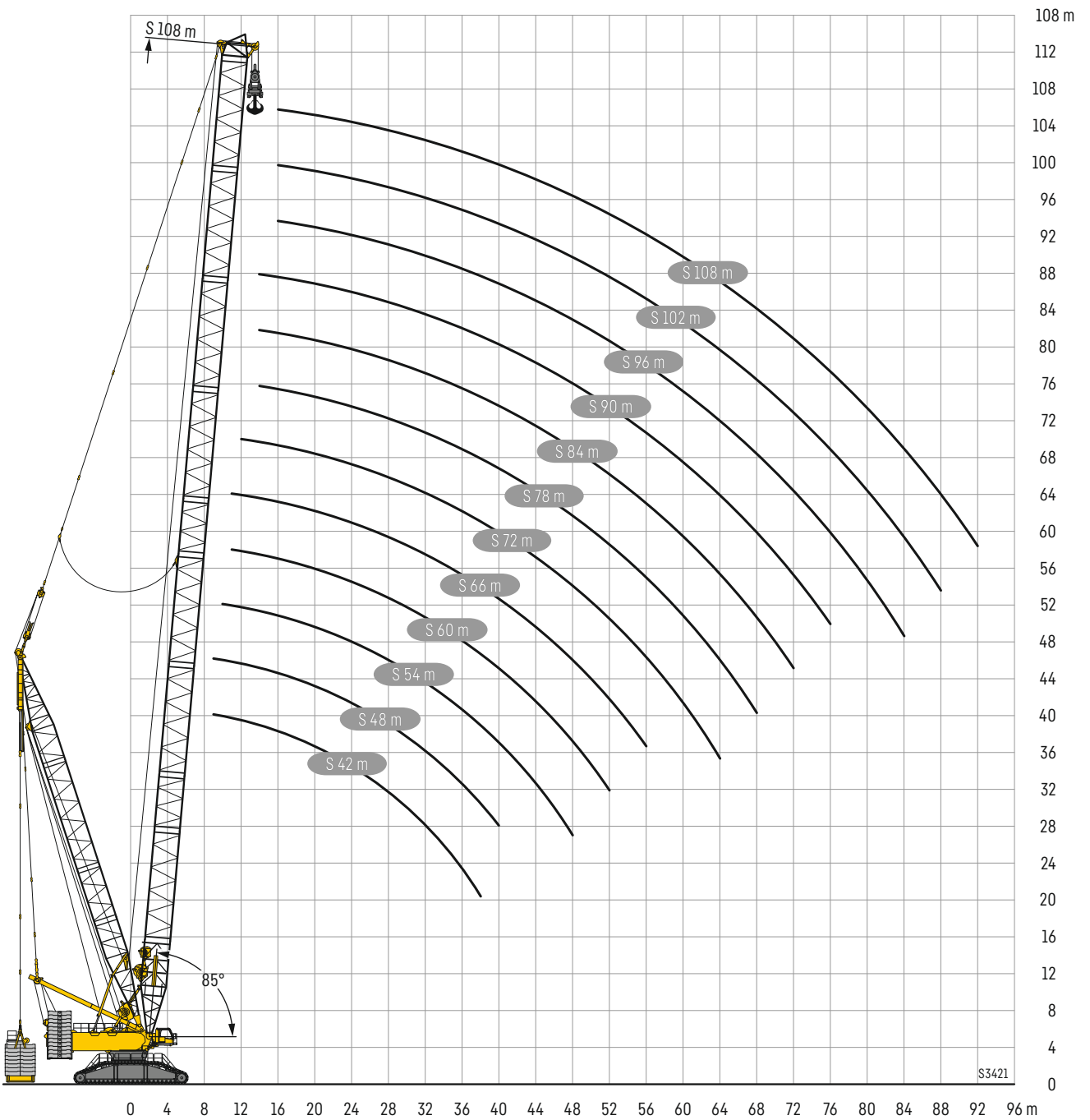

SL2DB/SL2DBV/SL2DBW

SL2 42 - 156

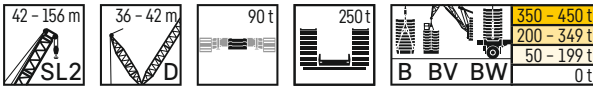

		SL2 42 - 156 m																				
		42 m	48 m	54 m	60 m	66 m	72 m	78 m	84 m	90 m	96 m	102 m	108 m	114 m	120 m	126 m	132 m	138 m	144 m	150 m	156 m	
9	B	D 36 m				D 42 m																
	BV	628	621																			
10	BV	628	621																			
	BW	632	626	622	600																	
11	B	635	627	623	603	582																
	BV	636	629	624	604	585																
12	B	638	631	625	605	585	562	538														
	BV	640	631	625	606	588	566	540														
14	B	647	640	635	607	589	567	544	516	483	443											
	BV	647	640	635	615	595	571	548	520	485	444											
16	B	650	649	634	600	585	567	545	516	483	443	399	359	320								
	BV	650	649	634	623	602	579	554	525	486	444	401										
18	B	610	621	616	598	585	563	541	517	483	441	397	359	319	279	243	226					
	BV	610	621	616	598	585	563	541	517	483	441	397	359	319	279	243	226					
20	B	544	571	574	568	575	563	536	512	478	438	397	357	318	277	242	226	198	174	153	134	
	BV	544	571	574	568	575	563	536	512	478	438	397	357	318	277	242	226	198	174	153	134	
22	B	476	507	519	516	541	531	522	504	476	434	391	355	318	275	241	226	197	172	152	133	
	BV	476	507	519	516	541	531	522	504	476	434	391	355	318	275	241	226	197	172	152	133	
24	B	422	451	468	473	495	492	483	477	466	432	388	352	312	272	241	224	196	171	151	132	
	BV	422	451	468	473	495	492	483	477	466	432	388	352	312	272	241	224	196	171	151	132	
26	B	378	402	420	432	458	452	448	441	434	416	380	350	307	267	238	222	194	170	149	131	
	BV	378	402	420	432	458	452	448	441	434	416	380	350	307	267	238	222	194	170	149	131	
28	B	342	365	384	392	424	420	414	411	405	395	366	342	301	264	235	220	192	169	148	129	
	BV	342	365	384	392	424	420	414	411	405	395	366	342	301	264	235	220	192	169	148	129	
30	B	310	335	350	360	393	391	386	381	378	373	354	330	290	259	232	218	190	167	146	128	
	BV	310	335	350	360	393	391	386	381	378	373	354	330	290	259	232	218	190	167	146	128	
32	B	282	307	320	332	367	364	361	357	353	350	337	319	286	253	227	215	187	165	143	126	
	BV	282	307	320	332	367	364	361	357	353	350	337	319	286	253	227	215	187	165	143	126	
34	B	259	281	295	305	343	341	337	335	331	328	321	307	279	249	223	210	185	163	141	124	
	BV	259	281	295	305	343	341	337	335	331	328	321	307	279	249	223	210	185	163	141	124	
36	B	237	258	272	280	317	320	316	314	311	309	304	295	269	241	220	205	182	160	139	123	
	BV	237	258	272	280	317	320	316	314	311	309	304	295	269	241	220	205	182	160	139	123	
38	B	216	238	251	259	296	301	298	295	292	291	287	282	262	230	214	202	180	158	138	122	
	BV	216	238	251	259	296	301	298	295	292	291	287	282	262	230	214	202	180	158	138	122	
40	B	197	206	217	232	240	277	284	281	279	276	274	271	267	254	223	207	198	177	156	136	121
	BV	197	206	217	232	240	277	284	281	279	276	274	271	267	254	223	207	198	177	156	136	121
44	B	173	182	197	206	243	247	251	249	247	245	242	240	235	210	193	191	170	150	132	117	
	BV	173	182	197	206	243	247	251	249	247	245	242	240	235	210	193	191	170	150	132	117	
48	B	221	238	251	259	296	303	302	299	296	294	291	283	264	224	201	199	176	149	127	116	
	BV	221	238	251	259	296	303	302	299	296	294	291	283	264	224	201	199	176	149	127	116	
52	B	156	156	189	196	198	201	202	200	198	195	194	191	173	170	156	136	119	109	99,2	91,7	
	BV	156	156	189	196	198	201	202	200	198	195	194	191	173	170	156	136	119	109	99,2	91,7	
56	B	166	172	175	182	181	180	180	177	177	175	166	160	149	130	112	104	92,6	86,8	83,3	83,3	
	BV	166	172	175	182	181	180	180	177	177	175	166	160	149	130	112	104	92,6	86,8	83,3	83,3	
60	B	229	238	245	245	245	245	245	245	243	241	237	234	205	185	187	167	139	117	107	108	
	BV	229	238	245	245	245	245	245	245	243	241	237	234	205	185	187	167	139	117	107	108	
64	B	154	157	162	162	164	163	162	161	160	155	149	141	125	107	107	99,2	91,7	86,8	83,3	83,3	
	BV	154	157	162	162	164	163	162	161	160	155	149	141	125	107	107	99,2	91,7	86,8	83,3	83,3	
68	B	128	132	133	134	136	134	135	135	133	129	127	121	114	104	99,8	93,1	88,6	83,3	83,3	83,3	
	BV	128	132	133	134	136	134	135	135	133	129	127	121	114	104	99,8	93,1	88,6	83,3	83,3	83,3	
72	B	116	118	120	122	121	122	121	122	121	122	121	120	117	113	109	92,6	86,8	83,3	83,3	83,3	
	BV	116	118	120	122	121	122	121	122	121	122	121	120	117	113	109	92,6	86,8	83,3	83,3	83,3	
76	B	108	110	110	111	112	111	112	111	112	111	112	111	108	106	103	88,6	83,3	83,3	83,3	83,3	
	BV	108	110	110	111	112	111	112	111	112	111	112	111	108	106	103	88,6	83,3	83,3	83,3	83,3	
80	B	101	102	102	103	104	104	104	104	104	104	104	104	98,4	98	95,8	85,3	80,2	80,2	80,2	80,2	
	BV	101	102	102	103	104	104	104	104	104	104	104	104	98,4	98	95,8	85,3	80,2	80,2	80,2	80,2	

SL2DB/SL2DBV/SL2DBW

SL2 42 - 156



		SL2 42 - 156 m																				
		42 m	48 m	54 m	60 m	66 m	72 m	78 m	84 m	90 m	96 m	102 m	108 m	114 m	120 m	126 m	132 m	138 m	144 m	150 m	156 m	
		D 36 m				D 42 m																
84	B BV BW										92,6 134 132	93,2 135 133	94 136 133	94,1 137 136	95,9 138 136	94,8 137 136	88,5 136 134	89,6 132 130	88,9 109 109	81,1 89,1 89,1	77 83,7 84,3	
88	B BV BW											83,7 122 121	84,2 125 123	83,4 127 125	87,6 128 126	85,1 128 127	81 126 125	81,1 124 122	81,7 106 106	76,6 86,1 86,1	73,6 80,9 81,3	
92	B BV BW												74,4 116 113	74,8 117 116	78,3 120 117	76,5 119 118	75,5 118 117	74,4 116 115	74,4 103 103	71,5 83,3 83,5	69,7 78,3 78,8	
96	B BV BW													68,5 109 107	70,6 111 109	70,5 112 110	70,2 110 109	68,9 109 108	68,7 100 99,7	66,4 80,6 81	65,2 75,9 76,6	
100	B BV BW														64,7 103 101	64,8 104 102	64,9 103 102	63,8 101 100	63,8 97,1 96,9	62 78,3 78,8	60,8 73,5 74,3	
104	B BV BW														59,6 95,7 94	60 96,9 94,8	59,7 95,9 94,9	59,4 93 91,6	59 93,6 93,5	57,9 76,2 76,9	56,7 71,5 71,9	
108	B BV BW															55,5 88,5 86,6	55,3 87 85,7	55 85,3 86	54,9 86,9 86	53,8 74,1 74,9	52,9 69,7 69,8	
112	B BV BW																50,7 79 77,4	50,3 79,2 77,7	50,8 80,2 78,6	49,7 72,6 73,1	49,3 67,8 67,8	
116	B BV BW																	45,7 73,7 72,6	46,6 74,5 72,7	45,6 70,8 71,4	45,6 66,4 66,2	
120	B BV BW																	41,7 68,4 67	42,4 69,3 67,4	42 66,7 67,2	41,8 65 64,7	
124	B BV BW																		38,7 64,4 62,8	38,8 60,7 60,9	38,4 62,7 62,3	
128	B BV BW																			35,5 54,9 55,2	35,4 59,3 58,6	
132	B BV BW																				32,4 55,6 55	

Hubhöhen

SL2DB/SL2DBV/SL2DBW

Lifting heights • Hauteurs de levage • Altezze di sollevamento • Alturas de elevación • Высота подъема

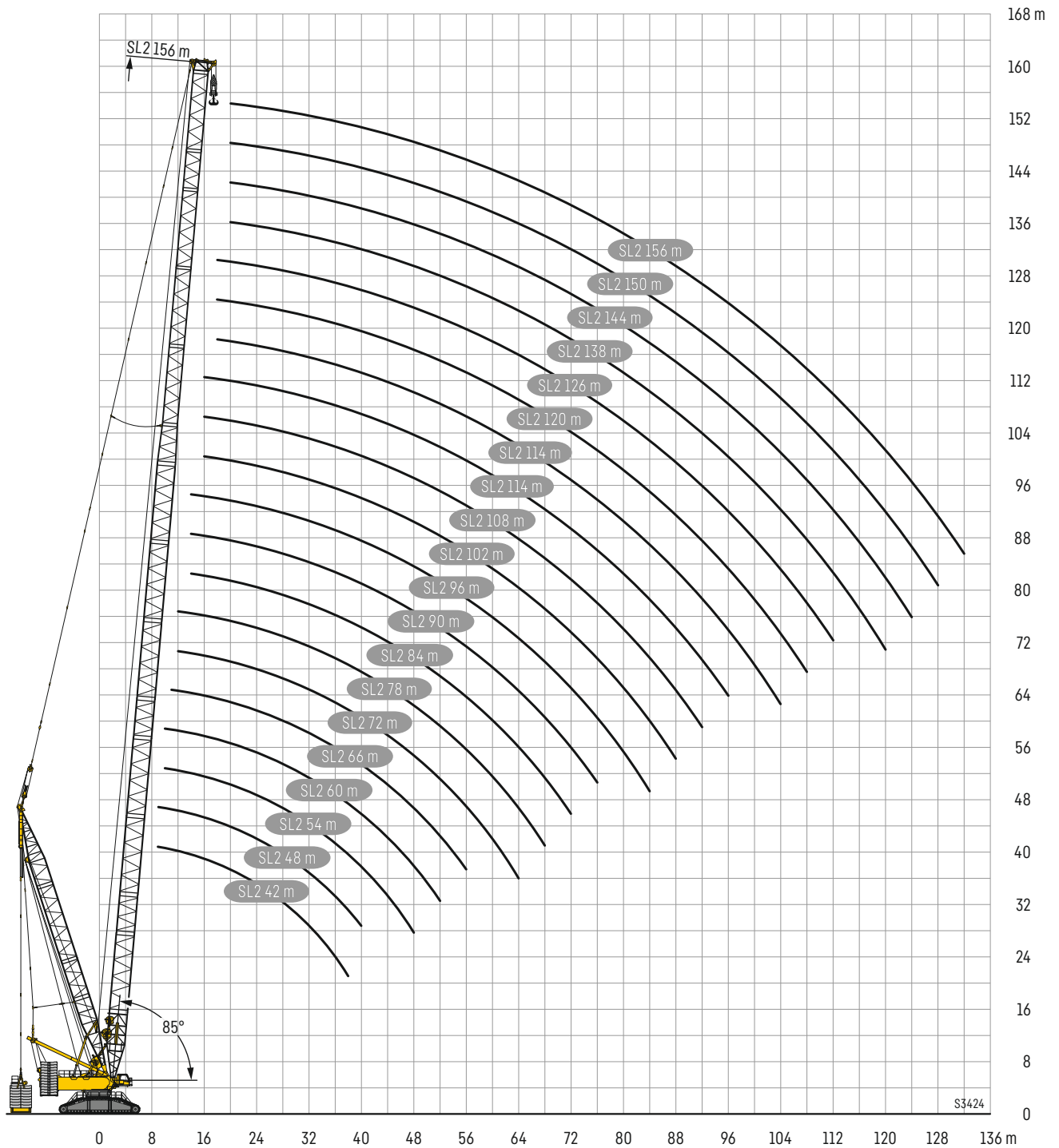

S2DB/S2DBW

S2 42 - 156

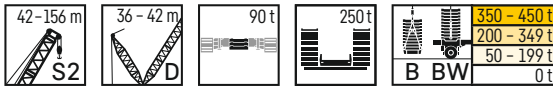

		S2 42 - 156 m																					
		42 m	48 m	54 m	60 m	66 m	72 m	78 m	84 m	90 m	96 m	102 m	108 m	114	120	126	132	138	144	150	156		
		D 36 m					D 42 m																
9	B BW	650 650	650 650																				
10	B BW	650 650	650 650	650 650	650 650																		
11	B BW	648 650	650 650	650 650	650 650	650 650																	
12	B BW	648 650	647 650	645 650	642 650	641 650	644 650	647 650															
14	B BW	648 650	647 650	645 650	645 650	648 650	646 650	646 650	578 596	516 527	462 470												
16	B BW	648 650	647 650	645 650	642 650	641 650	644 650	627 649	571 596	514 527	462 472	413 420	369 374	331 333									
18	B BW	609 650	624 650	631 650	615 650	635 650	618 650	598 642	567 593	510 527	456 473	409 421	369 375	329 334	295 297	261 264	228 228						
20	B BW	540 650	566 650	569 650	564 641	588 650	580 643	563 628	540 586	499 525	452 474	408 422	365 375	326 333	294 299	260 264	228 228	205 204	184 186	164 164	143 145	145	
22	B BW	474 607	500 625	517 617	511 614	536 628	529 626	509 604	486 573	444 522	444 474	400 421	363 373	323 329	291 300	260 263	228 228	204 203	183 186	163 163	145 144	144	
24	B BW	420 541	445 573	466 573	468 568	490 588	485 589	478 578	473 553	463 520	435 473	395 420	356 370	319 324	289 300	259 263	228 228	203 201	182 186	162 162	144 143	144	
26	B BW	376 485	399 519	416 527	427 524	452 559	446 545	442 541	436 541	431 506	415 468	386 417	351 366	316 319	284 299	255 262	227 228	202 200	181 185	162 161	142 141	141	
28	B BW	339 436	361 470	377 487	387 484	418 531	414 521	408 505	405 499	391 487	370 462	342 413	311 362	282 314	252 298	224 260	200 228	180 198	160 184	140 160	141 140	140	
30	B BW	307 391	332 428	346 445	352 450	388 499	385 494	380 482	376 469	374 461	367 446	353 407	330 357	303 297	276 296	251 258	223 228	199 197	177 184	158 159	140 139	139	
32	B BW	279 355	300 389	316 409	324 419	362 469	358 464	354 458	351 447	348 436	344 425	335 396	317 353	293 301	269 294	245 256	221 227	198 196	176 183	157 158	139 137	139	
34	B BW	256 322	274 354	291 377	301 390	337 440	334 435	331 431	328 425	326 417	322 405	317 386	304 349	283 296	261 293	239 255	216 227	194 194	175 182	156 157	138 136	136	
36	B BW	235 292	255 325	268 346	276 362	313 414	314 410	310 405	307 397	306 388	303 375	299 361	291 296	273 289	255 254	234 226	212 226	191 193	172 181	154 157	136 135	135	
38	B BW	214 266	234 296	247 318	255 337	293 391	295 387	292 382	288 379	288 376	285 370	282 361	278 341	263 296	248 285	228 252	209 225	189 192	169 179	152 156	135 134	135	
40	B BW		214 272	228 294	236 313	274 368	277 365	275 361	272 359	270 355	268 352	266 346	263 332	253 296	240 280	222 251	204 223	186 192	167 177	151 155	133 133	133	
44	B BW			193 257	202 271	239 325	242 328	245 325	243 322	242 321	239 317	237 314	235 309	231 289	223 270	208 248	194 220	177 191	161 172	147 154	131 131	131	
48	B BW			167 218	178 234	208 287	212 293	219 291	218 290	217 287	215 284	213 280	211 273	209 260	203 239	194 214	182 191	168 166	155 152	142 131	127 131	127	
52	B BW				152 201	185 253	190 261	194 265	194 264	197 263	194 261	192 258	191 255	189 251	184 246	179 228	169 208	158 188	148 161	136 149	123 131	123	
56	B BW					162 226	168 234	172 240	172 239	175 240	174 237	173 235	171 230	168 227	164 217	157 201	149 182	140 157	128 146	117 146	117 130	117	
60	B BW						149 209	153 216	156 218	159 219	160 217	158 215	157 214	156 210	154 208	151 203	145 192	139 175	131 152	121 143	111 128	111	
64	B BW						135 187	139 193	142 198	144 201	145 199	143 198	140 196	140 194	137 191	137 189	132 182	128 167	121 148	114 139	105 125	105	
68	B BW							124 175	128 180	130 183	129 183	128 182	130 181	128 179	128 177	124 174	121 171	118 160	113 144	107 137	99,2 122	99,2	
72	B BW								112 161	114 166	116 168	117 168	118 167	118 165	117 161	114 159	113 153	109 139	106 139	100 130	91,3 118	91,3	
76	B BW								105 151	106 154	108 156	108 155	108 153	108 145	106 150	106 148	104 143	102 134	98,3 125	91,7 114	84,2 114	84,2	
80	B BW									96,8 142	98,8 144	97,7 142	97,7 141	97,7 141	97,7 139	97,7 138	94,2 133	93,9 128	88,7 120	83,2 110	78,6 110	78,6	
84	B BW									85,3 128	87,2 131	85,6 130	85,6 131	85,6 131	85,6 129	84,3 128	84,3 124	85,3 119	79,7 114	73,3 106	73,2 106	73,2	
88	B BW										76,6 118	77,2 119	80,2 121	77,3 107	79,8 120	76,7 116	76,5 107	73,7 107	71,9 108	67,7 101	67,7 101	67,7	
92	B BW										71 110	71,6 112	70,6 99,2	71,6 111	70,6 111	70,6 108	69,7 108	67,7 94,7	66,6 101	62,7 95,3	62,7 95,3	62,7	
96	B BW												65,5 104	64,5 91,9	65,5 104	64,8 102	64,3 101	62,6 84,5	61,3 94,9	58,1 89,1	58,1 89,1	58,1	
100	B BW													59,4 85,2	59,8 96,1	59,8 92,7	59,1 94,1	58,1 74,2	56,3 87,8	53,5 83	53,5 83	53,5	
104	B BW													54,6 80,1	55,1 85,9	54,8 84	54,5 86,1	53,6 65,2	51,6 80,7	48,9 77,7	48,9 77,7	48,9	
108	B BW														50,1 77,7	49,4 77,8	50 78,4	48,9 58,8	46,9 73,5	44,3 72,8	44,3 72,8	44,3	
112	B BW															44,6 72,2	45,2 72,1	44,3 52,5	42,7 65,2	39,7 67,9	39,7 67,9	39,7	
116	B BW																40,7 66,5	40,3 46,5	38,6 57,5	35,7 62,9	35,7 62,9	35,7	
120	B BW																36,9 61,5	36,6 41,4	34,9 50,9	31,8 57,8	31,8 57,8	31,8	
124	B BW																	33 37,4	31,3 45,2	28,1 52	28,1 52	28,1	
128	B BW																		28,1 40,6	24,9 45,6	24,9 45,6	24,9	
132	B BW																			21,8 39,9	21,8 39,9	21,8	

Hubhöhen

S2DB/S2DBW

Lifting heights • Hauteurs de levage • Altezze di sollevamento • Alturas de elevación • Высота подъема

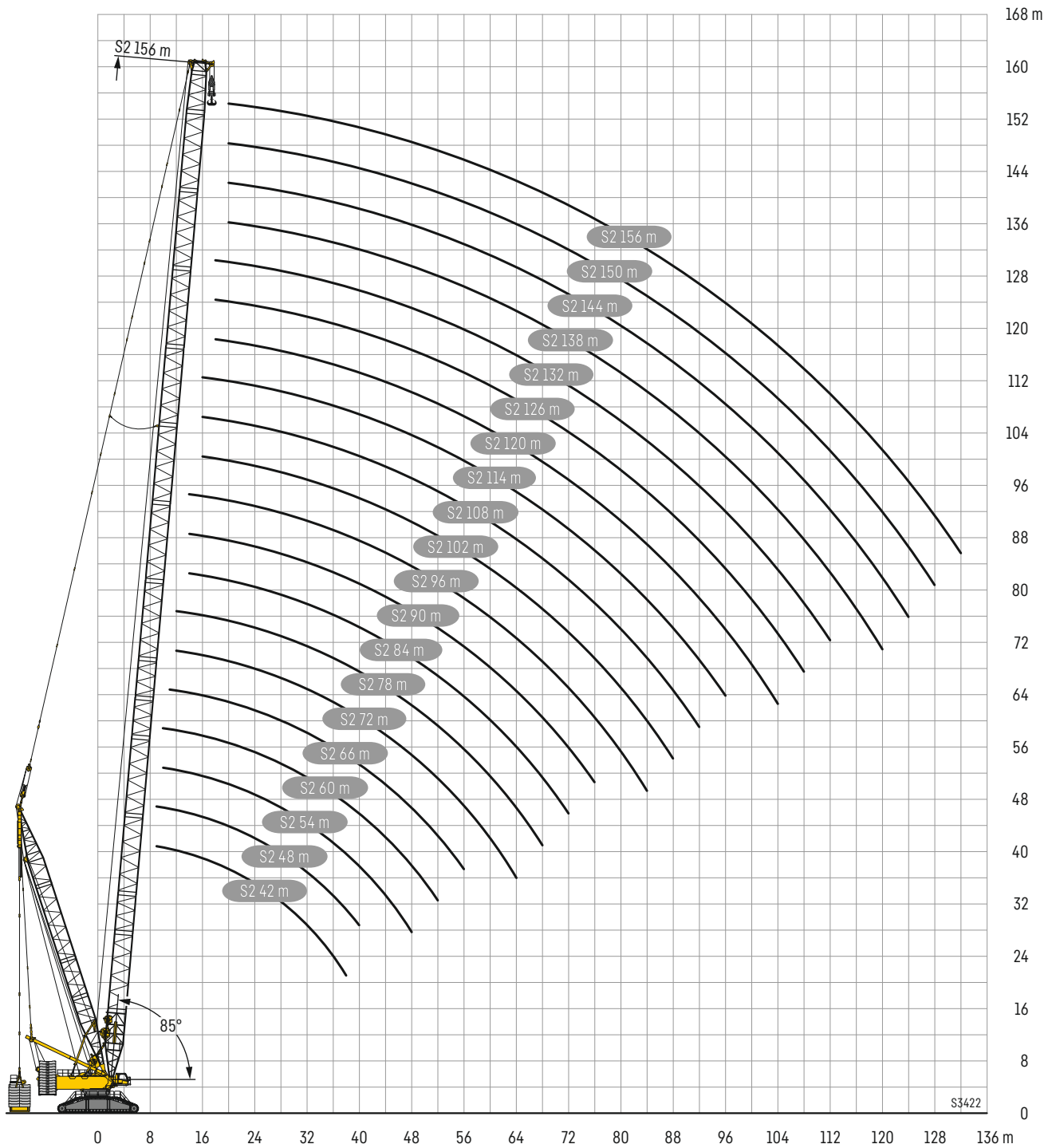

PDB/PDBW

P 48 - 150

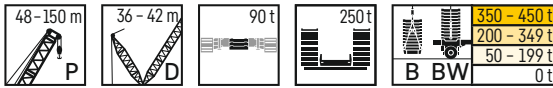

		P 48 - 150 m																			
		48 m	54 m	60 m	66 m	72 m	78 m	84 m	90 m	96 m	102 m	108 m	114	120	126	132	138	144	150		
		D 36 m				D 42 m															
h m	B BW																				
9	B	989																			
	BW	1000																			
10	B	961	937																		
	BW	1000	993																		
11	B	918	897	874	792																
	BW	985	960	932	806																
12	B	876	860	839	788	739															
	BW	948	926	901	809	754															
14	B	793	780	775	751	725	694	672	618												
	BW	881	863	841	802	754	733	706	661												
16	B	703	696	690	694	677	654	631	593	567	535	493									
	BW	824	805	791	773	744	716	687	654	610	559	513									
18	B	625	617	614	638	624	609	593	560	541	518	479	452	414	377	341					
	BW	752	747	732	727	704	680	654	629	601	558	512	468	426	386						
20	B	555	555	550	577	571	561	549	534	514	494	463	445	413	375	341	307				
	BW	679	674	669	685	664	644	622	602	577	546	502	465	425	386	332	315	283	244		
22	B	493	502	498	522	519	515	506	495	483	472	442	427	403	370	338	305				
	BW	617	611	607	638	629	612	592	574	554	529	488	449	414	384	327	315	281	249		
24	B	440	455	454	476	474	469	465	458	450	439	413	404	390	362	334	301				
	BW	561	559	555	585	587	581	565	548	530	506	465	433	399	375	324	312	280	248		
26	B	394	411	416	438	433	432	425	422	418	407	389	379	366	349	329	298				
	BW	509	512	510	551	541	543	537	524	506	483	442	416	384	365	321	311	277	245		
28	B	354	371	383	404	401	397	393	389	386	378	368	359	346	328	313	291				
	BW	460	474	470	521	511	503	502	497	482	460	422	400	370	353	315	306	274	243		
30	B	324	335	350	373	371	368	363	361	357	349	343	336	327	313	298	278				
	BW	422	438	436	487	482	474	467	466	457	437	404	384	356	340	309	300	271	240		
32	B	294	308	318	347	345	343	338	334	332	325	317	313	307	296	284	266				
	BW	383	401	406	455	452	447	440	435	432	416	385	369	343	327	302	294	269	237		
34	B	266	284	289	323	321	319	315	312	309	305	298	291	286	278	269	255				
	BW	349	367	379	426	422	419	415	410	407	397	369	354	330	315	294	286	266	235		
36	B	243	261	269	302	301	298	294	292	289	285	282	274	267	259	253	243				
	BW	320	339	352	399	397	393	389	386	383	378	355	341	318	304	285	277	261	233		
38	B	224	240	250	282	282	279	275	273	271	268	265	260	254	244	237	230				
	BW	293	312	326	376	373	370	365	363	361	357	340	328	308	294	276	267	254	230		
40	B	208	221	231	263	265	263	258	256	254	252	250	246	241	232	225	217				
	BW	268	288	302	354	352	349	345	342	340	337	325	315	299	286	268	258	247	228		
44	B		187	197	231	235	233	229	227	225	222	221	219	215	209	204	197				
	BW		244	263	314	316	313	309	305	303	300	296	288	278	269	254	243	233	221		
48	B		161	172	201	206	209	205	202	200	198	196	194	191	187	183	178				
	BW		211	228	280	284	282	278	272	270	270	265	261	256	248	238	228	221	210		
52	B			146	178	180	188	185	181	180	177	176	174	171	166	164	160				
	BW			196	247	254	254	252	240	242	244	226	236	232	226	221	214	208	199		
56	B				156	159	165	166	164	162	159	158	156	153	149	147	144				
	BW				219	225	229	228	215	214	219	192	215	211	205	202	198	195	188		
60	B					143	147	150	147	145	144	142	140	137	134	132	129				
	BW					200	207	207	195	191	195	165	196	192	187	184	180	179	175		
64	B					125	131	133	130	129	130	129	127	123	120	119	116				
	BW					181	186	188	180	171	174	144	179	176	171	169	165	164	160		
68	B						113	116	116	117	118	118	115	112	108	107	105				
	BW						165	169	167	157	155	128	165	161	156	154	151	150	147		
72	B							105	105	107	108	106	104	101	97,5	96,3	94,1				
	BW							154	154	147	142	114	151	148	144	141	138	138	135		
76	B								94,4	97	96,5	93,4	94,1	91,9	88,1	86,9	84,6				
	BW								140	139	131	104	139	136	132	130	124	126	123		
80	B									83,8	83,4	82,9	84,8	83,1	79,5	78,4	76,1				
	BW									127	124	95,5	128	125	121	120	110	116	113		
84	B									73,1	74	76	76,2	75,5	71,6	70,4	68,6				
	BW									115	116	88,8	118	115	112	110	96,6	107	104		
88	B										66,6	68,9	69	68,4	64,6	63,3	61,3				
	BW										107	84	109	106	103	101	84	98,7	96,5		
92	B											62	62,8	62,1	57,9	57	54,7				
	BW											81,3	98,9	97,9	94,6	93,4	73,5	90,6	88,9		
96	B												57,1	56,3	52,2	51	48,9				
	BW												88	90,2	87,2	85,8	64,4	83,4	81,6		
100	B													51,1	46,6	45,7	43,3				
	BW													82,9	80,1	79,3	55,8	76,6	75,1		
104	B														46,1	41,9	40,6				
	BW														75,5	74,5	73,1	70	68,9		
108	B															37,5	36,2	33,8			
	BW															68,6	67,2	64,7	62,6		
112	B																32				
	BW																61,6				
116	B																	25,7			
	BW																	33	54,7	48,9	
120	B																	22,1			
	BW																	29,4	50,2	42,8	
124	B																			45,6	37,4
	BW																				
128	B																				32,7
	BW																				

Hubhöhen

PDB/PDBW

Lifting heights • Hauteurs de levage • Altezze di sollevamento • Alturas de elevación • Высота подъема

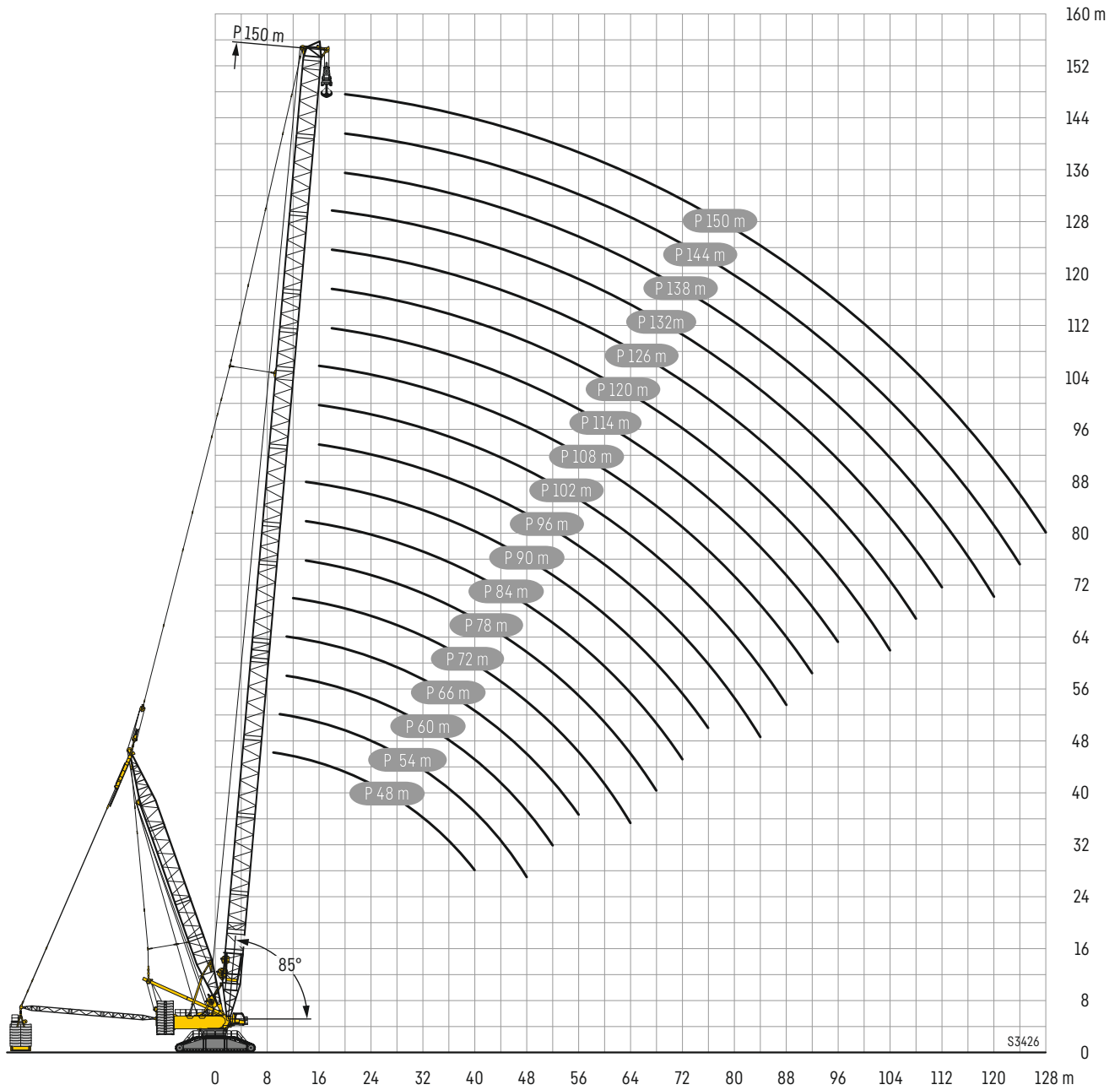

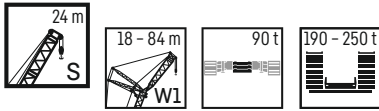

		S 24 m																											
		W1 18 m		W1 24 m		W1 30 m		W1 36 m		W1 42 m		W1 48 m		W1 54 m		W1 60 m		W1 66 m		W1 72 m		W1 78 m		W1 84 m					
		87/85*	WVmax	87/85*	WVmax	87/85*	WVmax	87/85*	WVmax	87/85*	WVmax	87/85*	WVmax	87/85*	WVmax	87/85*	WVmax	87/85*	WVmax	87/85*	WVmax	87/85*	WVmax	87/85*	WVmax	87/85*	WVmax		
11	11	479,0	479,0																										
12	12	435,0	435,0	413,0	413,0																								
14	14	366,0	366,0	349,0	349,0	333,0	333,0																						
16	16	315,0	315,0	302,0	302,0	288,0	288,0	277,0	277,0	223,0	223,0																		
18	18	277,0	277,0	265,0	265,0	254,0	254,0	244,0	244,0	235,0	235,0	228,0	228,0																
20	20	243,0	243,0	236,0	236,0	226,0	226,0	218,0	218,0	210,0	210,0	204,0	204,0	196,0	196,0														
22	22	211,0	211,0	212,0	212,0	203,0	203,0	196,0	196,0	189,0	189,0	184,0	184,0	177,0	177,0	172,0	172,0	165,0	165,0										
24	24	183,0 ⁽¹¹⁾	188,0	188,0	185,0	185,0	178,0	178,0	172,0	172,0	167,0	167,0	161,0	161,0	156,0	156,0	150,0	150,0	138,0	138,0									
26	26	160,0 ⁽¹¹⁾	168,0	168,0	167,0	167,0	163,0	163,0	157,0	157,0	153,0	153,0	147,0	147,0	143,0	143,0	138,0	138,0	134,0	134,0	113,0	113,0							
28	28	141,0 ⁽⁹⁾	151,0	151,0	150,0	150,0	149,0	149,0	144,0	144,0	140,0	140,0	135,0	135,0	131,0	131,0	126,0	126,0	123,0	123,0	118,0	118,0	115,0	115,0					
30	30	125,0 ⁽⁹⁾	133,0 ⁽¹¹⁾	137,0	137,0	136,0	136,0	133,0	133,0	129,0	129,0	124,0	124,0	121,0	121,0	116,0	116,0	113,0	113,0	109,0	109,0	106,0	106,0						
32	32	110,0 ⁽⁷⁾	119,0 ⁽¹¹⁾	125,0	125,0	124,0	124,0	123,0	123,0	120,0	120,0	115,0	115,0	112,0	112,0	108,0	108,0	105,0	105,0	101,0	101,0	98,1	98,1						
34	34	97,8 ⁽⁷⁾	106,0 ⁽¹⁰⁾	114,0	114,0	114,0	114,0	113,0	113,0	112,0	112,0	107,0	107,0	104,0	104,0	99,9	99,9	97,4	97,4	93,5	93,5	90,9	90,9						
36	36		95,6 ⁽¹⁰⁾	101,0 ⁽¹¹⁾	105,0	105,0	104,0	104,0	104,0	104,0	99,6	99,6	97,1	97,1	92,9	92,9	90,6	90,6	86,6	86,6	84,5	84,5							
38	38		85,0 ⁽⁸⁾	91,6 ⁽¹¹⁾	97,4	97,4	96,5	96,5	96,2	96,2	93,1	93,1	90,7	90,7	86,6	86,6	84,4	84,4	80,5	80,5	78,6	78,6							
40	40		76,5 ⁽⁸⁾	82,5 ⁽¹⁰⁾	90,4	90,4	89,6	89,6	89,3	89,3	87,2	87,2	84,9	84,9	80,9	80,9	78,8	78,8	75,0	75,0	73,1	73,1							
44	44					72,1 ⁽¹⁰⁾	78,0	78,0	77,7	77,7	76,2	76,2	74,8	74,8	71,0	71,0	69,1	69,1	65,6	65,6	63,8	63,8							
48	48					59,5 ⁽¹⁰⁾	64,1 ⁽¹¹⁾	68,2	68,2	65,9	65,9	65,3	65,3	62,7	62,7	60,9	60,9	57,5	57,5	55,8	55,8								
52	52					46,5 ⁽⁸⁾	52,2 ⁽¹⁰⁾	60,1	60,1	58,2	58,2	57,6	57,6	55,7	55,7	54,0	54,0	50,6	50,6	49,1	49,1								
56	56						41,7 ⁽⁸⁾	48,1 ⁽¹¹⁾	51,9	51,9	51,1	51,1	49,2	49,2	48,0	48,0	44,7	44,7	43,3	43,3									
60	60							38,7 ⁽¹¹⁾	40,9 ⁽¹¹⁾	44,0	44,0	42,2	42,2	41,5	41,5	39,6	39,6	38,1	38,1										
64	64							30,0 ⁽⁹⁾	33,9 ⁽¹¹⁾	39,6	39,6	37,7	37,7	36,9	36,9	35,1	35,1	33,7	33,7										
68	68								26,0 ⁽⁹⁾	30,7 ⁽¹¹⁾	33,8	33,8	32,9	32,9	31,1	31,1	29,7	29,7											
72	72								18,5 ⁽⁷⁾	24,0 ⁽¹¹⁾	26,7 ⁽¹¹⁾	29,5	29,5	27,6	27,6	26,3	26,3												
76	76									17,5 ⁽⁹⁾	21,1 ⁽¹¹⁾	26,6	26,6	24,6	24,6	23,2	23,2												
80	80										14,3 ⁽⁹⁾	18,2 ⁽¹¹⁾	20,8	20,8	20,0	20,0													
84	84										8,2 ⁽⁷⁾	13,3 ⁽¹¹⁾	15,7	15,7	15,7	15,7													
88	88																												

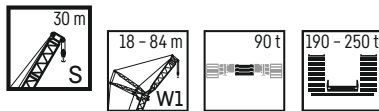

		S 30 m																											
		W1 18 m		W1 24 m		W1 30 m		W1 36 m		W1 42 m		W1 48 m		W1 54 m		W1 60 m		W1 66 m		W1 72 m		W1 78 m		W1 84 m					
		87/85*	WVmax	87/85*	WVmax	87/85*	WVmax	87/85*	WVmax	87/85*	WVmax	87/85*	WVmax	87/85*	WVmax	87/85*	WVmax	87/85*	WVmax	87/85*	WVmax	87/85*	WVmax	87/85*	WVmax	87/85*	WVmax		
11	11	452,0	452,0																										
12	12	412,0	412,0																										
14	14	348,0	348,0	333,0	333,0	318,0	318,0																						
16	16	301,0	301,0	289,0	289,0	276,0	276,0	265,0	265,0																				
18	18	265,0	265,0	255,0	255,0	244,0	244,0	234,0	234,0	226,0	226,0	219,0	219,0																
20	20	237,0	237,0	227,0	227,0	217,0	217,0	210,0	210,0	202,0	202,0	196,0	196,0	189,0	189,0														
22	22	211,0	211,0	205,0	205,0	196,0	196,0	189,0	189,0	182,0	182,0	177,0	177,0	170,0	170,0	166,0	166,0												
24	24	184,0 ⁽¹¹⁾	187,0	187,0	178,0	178,0	172,0	172,0	166,0	166,0	161,0	161,0	155,0	155,0	151,0	151,0	146,0	146,0	115,0	115,0									
26	26	159,0 ⁽¹¹⁾	168,0	168,0	163,0	163,0	157,0	157,0	152,0	152,0	147,0	147,0	142,0	142,0	138,0	138,0	134,0	134,0	129,0	129,0									
28	28	139,0 ⁽⁹⁾	151,0	151,0	150,0	150,0	144,0	144,0	139,0	139,0	136,0	136,0	130,0	130,0	127,0	127,0	123,0	123,0	119,0	119,0	115,0	115,0							
30	30	125,0 ⁽⁹⁾	134,0 ⁽¹¹⁾	136,0	136,0	134,0	134,0	129,0	129,0	125,0	125,0	120,0	120,0	117,0	117,0	113,0	113,0	110,0	110,0	106,0	106,0	102,0	102,0						
32	32	111,0 ⁽⁹⁾	119,0 ⁽¹¹⁾	125,0	125,0	124,0	124,0	119,0	119,0	116,0	116,0	111,0	111,0	108,0	108,0	105,0	105,0	101,0	101,0	98,1	98,1	94,7	94,7						
34	34	96,9 ⁽⁷⁾	106,0 ⁽¹⁰⁾	114,0	114,0	114,0	114,0	111,0	111,0	108,0	108,0	103,0	103,0	101,0	101,0	97,4	97,4	94,1	94,1	91,1	91,1	87,7	87,7						
36	36	87,1 ⁽⁷⁾	95,4 ⁽¹⁰⁾	102,0 ⁽¹¹⁾	105,0	105,0	104,0	104,0	101,0	101,0	96,3	96,3	93,8	93,8	90,7	90,7	87,4	87,4	84,6	84,6	81,5	81,5							
38	38		85,7 ⁽¹⁰⁾	91,3 ⁽¹¹⁾	97,1	97,1	96,2	96,2	94,3	94,3	90,0	90,0	87,6	87,6	84,6	84,6	81,5	81,5	78,6	78,6	75,7	75,7							
40	40		75,6 ⁽⁸⁾	81,5 ⁽¹⁰⁾	90,1	90,1	89,4	89,4	88,5	88,5	84,3	84,3	82,0	82,0	79,0	79,0	76,0	76,0	73,4	73,4	70,5	70,5							
44	44			66,6 ⁽¹⁰⁾	72,4 ⁽¹¹⁾	77,7	77,7	74,4	74,4	74,4	74,4	72,3	72,3	69,4	69,4	66,6	66,6	64,2	64,2	61,4	61,4								
48	48			52,4 ⁽⁷⁾	58,7 ⁽¹⁰⁾	63,7 ⁽¹¹⁾	67,7	67,7	65,3	65,3	64,1	64,1	61,3	61,3	58,7	58,7	56,3	56,3	53,7	53,7									
52	52				46,3 ⁽⁸⁾	51,6 ⁽¹⁰⁾	59,5	59,5	57,7	57,7	57,1	57,1	54,5	54,5	51,9	51,9	49,6	49,6	47,1	47,1									
56	56				35,1 ⁽⁶⁾	41,5 ⁽¹⁰⁾	46,8 ⁽¹¹⁾	51,3	51,3	50,6	50,6	48,6	48,6	46,1	46,1	43,8	43,8	41,4	41,4	38,8	38,8	36,4	36,4						
60	60					31,8 ⁽⁸⁾	37,6 ⁽¹¹⁾	43,7	43,7	42,2	42,2	40,3	40,3	39,1	39,1	37,7	37,7	36,5	36,5	34,4	34,4	32,1	32,1						
64	64						29,1 ⁽⁹⁾	33,0 ⁽¹¹⁾	39,1	39,1	37,7	37,7	36,5	36,5	34,4	34,4	32,1	32,1	30,6	30,6	28,3	28,3							
68	68						20,9 ⁽⁷⁾	26,2 ⁽¹¹⁾	33,7	33,7	32,5	32,5	30,6	30,6	29,0	29,0	27,2	27,2	25,9	25,9	24,9	24,9							
72	72							18,8 ⁽⁹⁾	23,8 ⁽¹¹⁾	33,7	33,7	32,5	32,5	30,6	30,6	29,0	29,0	27,2	27,2	25,9	25,9								
76	76								11,8 ⁽⁷⁾	16,5 ⁽⁹⁾	20,0 ⁽¹¹⁾	26,1	26,1	24,3	2														



m		S 36 m																								m	
		W1 18 m		W1 24 m		W1 30 m		W1 36 m		W1 42 m		W1 48 m		W1 54 m		W1 60 m		W1 66 m		W1 72 m		W1 78 m		W1 84 m			
		87/85°	WVmax	87/85°	WVmax	87/85°	WVmax	87/85°	WVmax	87/85°	WVmax	87/85°	WVmax	87/85°	WVmax	87/85°	WVmax	87/85°	WVmax	87/85°	WVmax	87/85°	WVmax	87/85°	WVmax		
11	428,0	428,0																									11
12	390,0	390,0																									12
14	332,0	332,0	317,0	317,0	304,0	304,0																					14
16	289,0	289,0	276,0	276,0	265,0	265,0	255,0	255,0																			16
18	255,0	255,0	244,0	244,0	234,0	234,0	226,0	226,0	217,0	217,0																	18
20	228,0	228,0	218,0	218,0	210,0	210,0	202,0	202,0	194,0	194,0	188,0	188,0	171,0	171,0													20
22	207,0	207,0	197,0	197,0	189,0	189,0	183,0	183,0	176,0	176,0	170,0	170,0	165,0	165,0	131,0	131,0											22
24	183,0*	183,0	180,0	180,0	172,0	172,0	166,0	166,0	160,0	160,0	155,0	155,0	150,0	150,0	145,0	145,0	141,0	141,0									24
26		160,0 ¹⁾	165,0	165,0	158,0	158,0	152,0	152,0	146,0	146,0	142,0	142,0	137,0	137,0	133,0	133,0	129,0	129,0	124,0	124,0							26
28		140,0 ²⁾	151,0	151,0	145,0	145,0	140,0	140,0	134,0	134,0	131,0	131,0	126,0	126,0	122,0	122,0	118,0	118,0	114,0	114,0	111,0	111,0					28
30		123,0 ³⁾	134,0*	134,0	135,0	135,0	130,0	130,0	124,0	124,0	121,0	121,0	117,0	117,0	113,0	113,0	109,0	109,0	105,0	105,0	102,0	102,0	98,5	98,5			30
32		111,0 ³⁾		119,0 ³⁾	125,0	125,0	120,0	120,0	115,0	115,0	112,0	112,0	108,0	108,0	105,0	105,0	101,0	101,0	97,7	97,7	94,4	94,4	91,1	91,1			32
34		98,5 ³⁾		106,0 ³⁾	114,0	114,0	110,0	110,0	107,0	107,0	104,0	104,0	101,0	101,0	97,2	97,2	93,9	93,9	90,5	90,5	87,6	87,6	84,3	84,3			34
36				93,8 ³⁾	103,0*	103,0	105,0	105,0	100,0	100,0	97,2	97,2	93,7	93,7	90,5	90,5	87,4	87,4	84,1	84,1	81,3	81,3	78,3	78,3			36
38				84,3 ³⁾		91,3 ³⁾	97,2	97,2	93,8	93,8	91,0	91,0	87,6	87,6	84,5	84,5	81,5	81,5	78,4	78,4	75,7	75,7	72,7	72,7			38
40				76,0 ³⁾		82,3 ³⁾	90,2	90,2	88,2	88,2	85,4	85,4	82,1	82,1	79,0	79,0	76,1	76,1	73,2	73,2	70,6	70,6	67,7	67,7			40
44				59,7 ³⁾		66,4 ³⁾		72,4 ³⁾	77,4	77,4	75,7	75,7	72,4	72,4	69,6	69,6	66,8	66,8	64,1	64,1	61,6	61,6	58,9	58,9			44
48						51,5 ³⁾		57,6 ³⁾	65,3*	65,3	66,7	66,7	64,5	64,5	61,7	61,7	59,0	59,0	56,4	56,4	54,0	54,0	51,4	51,4			48
52						40,7 ³⁾		46,2 ³⁾		51,7 ³⁾	58,9	58,9	57,6	57,6	55,0	55,0	52,3	52,3	49,8	49,8	47,5	47,5	45,1	45,1			52
56								35,2 ³⁾		41,1 ³⁾		46,5 ³⁾	51,2	51,2	49,4	49,4	46,7	46,7	44,1	44,1	41,9	41,9	39,5	39,5			56
60										30,4 ³⁾		36,6 ³⁾	42,6*	42,6	43,1	43,1	41,7	41,7	39,3	39,3	37,0	37,0	34,7	34,7			60
64										23,0 ³⁾		29,2 ³⁾		32,7 ³⁾	38,6	38,6	37,2	37,2	35,0	35,0	32,7	32,7	30,4	30,4			64
68												21,1 ³⁾		25,7 ³⁾		29,2 ³⁾	33,3	33,3	31,4	31,4	29,0	29,0	26,7	26,7			68
72												13,3 ³⁾		17,4 ³⁾		22,7 ³⁾	28,6*	28,6	28,2	28,2	25,7	25,7	23,4	23,4			72
76												7,7 ³⁾		11,4 ³⁾		16,4 ³⁾		19,1 ³⁾	25,7	25,7	22,8	22,8	20,5	20,5			76
80																		13,3 ³⁾		16,0 ³⁾	20,4	20,4	17,9	17,9			80
84																					17,0*	17,0	15,7	15,7			84
88																							14,0	14,0			88



m		S 42 m																								m	
		W1 18 m		W1 24 m		W1 30 m		W1 36 m		W1 42 m		W1 48 m		W1 54 m		W1 60 m		W1 66 m		W1 72 m		W1 78 m		W1 84 m			
		87/85°	WVmax	87/85°	WVmax	87/85°	WVmax	87/85°	WVmax	87/85°	WVmax	87/85°	WVmax	87/85°	WVmax	87/85°	WVmax	87/85°	WVmax	87/85°	WVmax	87/85°	WVmax	87/85°	WVmax		
12	370,0	370,0																									12
14	316,0	316,0	303,0	303,0																							14
16	276,0	276,0	265,0	265,0	253,0	253,0	244,0	244,0																			16
18	244,0	244,0	235,0	235,0	225,0	225,0	216,0	216,0	209,0	209,0																	18
20	219,0	219,0	210,0	210,0	201,0	201,0	194,0	194,0	187,0	187,0	181,0	181,0															20
22	198,0	198,0	190,0	190,0	182,0	182,0	176,0	176,0	170,0	170,0	164,0	164,0	158,0	158,0													22
24	176,0*	176,0	174,0	174,0	166,0	166,0	160,0	160,0	154,0	154,0	149,0	149,0	144,0	144,0	140,0	140,0											24
26		156,0 ¹⁾	160,0	160,0	152,0	152,0	147,0	147,0	142,0	142,0	137,0	137,0	132,0	132,0	128,0	128,0	124,0	124,0	120,0	120,0							26
28		137,0 ¹⁾	148,0	148,0	140,0	140,0	135,0	135,0	130,0	130,0	126,0	126,0	122,0	122,0	118,0	118,0	114,0	114,0	110,0	110,0	106,0	106,0					28
30		123,0 ¹⁾	133,0*	133,0	133,0	130,0	130,0	125,0	125,0	120,0	120,0	116,0	116,0	112,0	112,0	109,0	109,0	105,0	105,0	101,0	101,0	98,1	98,1	94,6	94,6		30
32		107,0 ³⁾		118,0 ³⁾	121,0	121,0	116,0	116,0	112,0	112,0	108,0	108,0	104,0	104,0	101,0	101,0	97,3	97,3	93,8	93,8	90,7	90,7	87,4	87,4			32
34		97,0 ³⁾		105,0 ³⁾	113,0	113,0	108,0	108,0	104,0	104,0	100,0	100,0	96,8	96,8	93,5	93,5	90,3	90,3	87,0	87,0	84,1	84,1	80,9	80,9			34
36		86,7 ³⁾		94,6 ³⁾	102,0*	102,0	101,0	101,0	97,3	97,3	93,7	93,7	90,3	90,3	87,1	87,1	84,0	84,0	80,8	80,8	78,1	78,1	75,0	75,0			36
38		76,3 ³⁾		83,9 ³⁾		90,9 ³⁾	95,4	95,4	91,2	91,2	87,7	87,7	84,4	84,4	81,3	81,3	78,3	78,3	75,3	75,3	72,7	72,7	69,7	69,7			38
40				75,8 ³⁾		81,3 ³⁾	89,9	89,9	85,7	85,7	82,2	82,2	79,0	79,0	76,0	76,0	73,2	73,2	70,3	70,3	67,8	67,8	64,9	64,9			40
44				59,6 ³⁾		64,1 ³⁾		71,2 ³⁾	76,4	76,4	72,9	72,9	69,7	69,7	66,9	66,9	64,2	64,2	61,4	61,4	59,0	59,0	56,3	56,3			44
48						51,1 ³⁾		57,6 ³⁾	64,6*	64,6	65,2	65,2	61,9	61,9	59,2	59,2	56,6	56,6	54,0	54,0	51,7	51,7	49,1	49,1			48
52						38,4 ³⁾		45,6 ³⁾		50,8 ³⁾	58,3	58,3	55,5	55,5	52,7	52,7	50,1	50,1	47,6	47,6	45,4	45,4	42,9	42,9			52
56						29,5 ³⁾		35,2 ³⁾		39,1 ³⁾	44,5 ³⁾	50,1	50,1	47,2	47,2	44,6	44,6	42,1	42,1	39,9	39,9	37,5	37,5			56	
60								25,2 ³⁾		30,6 ³⁾	35,8 ³⁾	41,8*	41,8	42,5	42,5	39,8	39,8	37,4	37,4	35,2	35,2	32,8	32,8			60	
64										21,0 ³⁾	27,8 ³⁾	31,4 ³⁾	38,0	38,0	35,7	35,7	33,2	33,2	31,0	31,0	28,7	28,7	26,7	26,7			64
68										14,1 ³⁾	19,9 ³⁾	23,8 ³⁾	27,4 ³⁾	32,3	32,3	29,7	29,7	27,3	27,3	25,1	25,1	23,1	23,1			68	
72											12,1 ³⁾	16,9 ³⁾	20,7 ³⁾	24,4*	27,4	26,6	26,6	24,1	24,1	21,8	21,8	19,7	19,7				

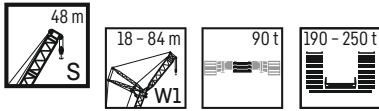

48 m		S 48 m																48 m											
		W1 18 m		W1 24 m		W1 30 m		W1 36 m		W1 42 m		W1 48 m		W1 54 m		W1 60 m				W1 66 m		W1 72 m		W1 78 m		W1 84 m			
		87/85°	WVmax	87/85°	WVmax	87/85°	WVmax	87/85°	WVmax	87/85°	WVmax	87/85°	WVmax	87/85°	WVmax	87/85°	WVmax			87/85°	WVmax	87/85°	WVmax	87/85°	WVmax	87/85°	WVmax	87/85°	WVmax
12	351,0	351,0																									12		
14	302,0	302,0	289,0	289,0																								14	
16	264,0	264,0	253,0	253,0	242,0	242,0																						16	
18	234,0	234,0	225,0	225,0	215,0	215,0	207,0	207,0																				18	
20	210,0	210,0	202,0	202,0	193,0	193,0	186,0	186,0	180,0	180,0	173,0	173,0																20	
22	191,0	191,0	183,0	183,0	175,0	175,0	169,0	169,0	163,0	163,0	157,0	157,0	152,0	152,0														22	
24	168,0*	170,0 ¹¹⁾	167,0	167,0	159,0	159,0	154,0	154,0	148,0	148,0	143,0	143,0	139,0	139,0	135,0	135,0												24	
26		151,0 ¹¹⁾	153,0	153,0	146,0	146,0	141,0	141,0	136,0	136,0	131,0	131,0	127,0	127,0	124,0	124,0	119,0	119,0										26	
28		134,0 ¹¹⁾	142,0	142,0	135,0	135,0	130,0	130,0	125,0	125,0	121,0	121,0	117,0	117,0	114,0	114,0	109,0	109,0	107,0	107,0	94,8	94,8						28	
30		118,0 ¹¹⁾	127,0*	127,0	125,0	125,0	120,0	120,0	116,0	116,0	112,0	112,0	108,0	108,0	105,0	105,0	101,0	101,0	98,5	98,5	94,1	94,1	90,6	90,6				30	
32		105,0 ¹¹⁾		114,0 ¹¹⁾	116,0	116,0	112,0	112,0	108,0	108,0	104,0	104,0	100,0	100,0	97,8	97,8	93,3	93,3	91,2	91,2	87,0	87,0	83,6	83,6				32	
34		92,1 ⁹⁾		102,0 ¹¹⁾	109,0	109,0	104,0	104,0	100,0	100,0	96,5	96,5	93,1	93,1	90,9	90,9	86,6	86,6	84,6	84,6	80,6	80,6	77,4	77,4				34	
36		83,0 ⁹⁾		90,9 ¹¹⁾	97,9*	97,9	97,6	97,6	93,6	93,6	90,1	90,1	86,8	86,8	84,7	84,7	80,6	80,6	78,7	78,7	74,8	74,8	71,7	71,7				36	
38		73,9 ⁹⁾		81,2 ¹¹⁾		87,6 ¹¹⁾	91,8	91,8	87,7	87,7	84,3	84,3	81,1	81,1	79,1	79,1	75,1	75,1	73,4	73,4	69,6	69,6	66,7	66,7				38	
40		64,8 ⁹⁾		71,7 ¹⁰⁾		78,1 ¹¹⁾	86,7	86,7	82,4	82,4	79,0	79,0	75,9	75,9	74,0	74,0	70,1	70,1	68,5	68,5	64,9	64,9	62,0	62,0				40	
44				57,4 ¹⁰⁾		62,4 ¹¹⁾		68,9 ¹¹⁾	73,4	73,4	70,0	70,0	66,9	66,9	65,1	65,1	61,4	61,4	59,9	59,9	56,4	56,4	53,7	53,7				44	
48						48,9 ¹⁰⁾		55,1 ¹¹⁾	62,6*	62,6	62,5	62,5	59,4	59,4	57,7	57,7	54,1	54,1	52,7	52,7	49,3	49,3	46,8	46,8				48	
52						37,3 ¹⁰⁾		42,4 ¹⁰⁾		48,3 ¹¹⁾	56,7	56,7	53,1	53,1	51,4	51,4	47,9	47,9	46,5	46,5	43,2	43,2	40,7	40,7				52	
56						26,4 ⁸⁾		32,7 ¹⁰⁾		36,6 ¹⁰⁾		43,0 ¹¹⁾	47,9	47,9	46,0	46,0	42,5	42,5	41,1	41,1	37,9	37,9	35,5	35,5				56	
60								21,9 ⁸⁾		28,2 ¹⁰⁾		33,7 ¹¹⁾	40,7*	40,7	41,4	41,4	37,8	37,8	36,4	36,4	33,3	33,3	31,0	31,0				60	
64										14,7 ⁸⁾		19,9 ¹⁰⁾		25,3 ¹¹⁾		29,2 ¹¹⁾	37,7	37,7	33,9	33,9	32,4	32,4	29,2	29,2	26,9	26,9		64	
68													17,8 ¹¹⁾		21,6 ¹¹⁾		26,3 ¹¹⁾	30,5	30,5	28,8	28,8	25,7	25,7	23,4	23,4				68
72														14,8 ¹¹⁾		19,4 ¹¹⁾	25,2*	25,2	25,7	25,7	22,5	22,5	20,3	20,3				72	
76															8,1 ¹¹⁾			15,4 ¹¹⁾	23,3	23,3	19,8	19,8	17,5	17,5				76	
80																				11,5 ¹⁰⁾	17,5	17,5	15,0	15,0				80	
84																						13,3*	13,3	12,9	12,9				84
88																								11,2	11,2				88

1) 12° 2) 17° 3) 22° 4) 27° 5) 32° 6) 37° 7) 42° 8) 47° 9) 52° 10) 57° 11) 62°



		S 54 m																						
		W1 18 m		W1 24 m		W1 30 m		W1 36 m		W1 42 m		W1 48 m		W1 54 m		W1 60 m		W1 66 m		W1 72 m				
		87/85°	WVmax	87/85°	WVmax	87/85°	WVmax	87/85°	WVmax	87/85°	WVmax	87/85°	WVmax	87/85°	WVmax	87/85°	WVmax	87/85°	WVmax	87/85°	WVmax	87/85°	WVmax	
12	12	333,0	333,0																					12
14	14	287,0	287,0	276,0	276,0																			14
16	16	252,0	252,0	243,0	243,0	232,0	232,0																	16
18	18	224,0	224,0	216,0	216,0	207,0	207,0	198,0	198,0															18
20	20	201,0	201,0	194,0	194,0	186,0	186,0	178,0	178,0	172,0	172,0													20
22	22	183,0	183,0	176,0	176,0	169,0	169,0	162,0	162,0	156,0	156,0	152,0	152,0	146,0	146,0									22
24	24	160,0*	164,0 ⁽¹¹⁾	161,0	161,0	154,0	154,0	148,0	148,0	142,0	142,0	138,0	138,0	133,0	133,0	129,0	129,0							24
26	26		145,0 ⁽¹¹⁾	148,0	148,0	141,0	141,0	135,0	135,0	131,0	131,0	127,0	127,0	122,0	122,0	119,0	119,0	114,0	114,0					26
28	28		129,0 ⁽¹¹⁾	137,0	137,0	130,0	130,0	125,0	125,0	120,0	120,0	117,0	117,0	112,0	112,0	109,0	109,0	105,0	105,0	102,0	102,0			28
30	30		113,0 ⁽¹¹⁾	122,0*	123,0 ⁽¹¹⁾	121,0	121,0	116,0	116,0	111,0	111,0	108,0	108,0	104,0	104,0	101,0	101,0	96,6	96,6	94,3	94,3			30
32	32		101,0 ⁽¹¹⁾		111,0 ⁽¹¹⁾	113,0	113,0	107,0	107,0	103,0	103,0	101,0	101,0	96,1	96,1	93,7	93,7	89,4	89,4	87,3	87,3			32
34	34		88,8 ⁽¹¹⁾		98,8 ⁽¹¹⁾	106,0	106,0	100,0	100,0	96,2	96,2	93,6	93,6	89,3	89,3	87,1	87,1	83,0	83,0	81,0	81,0			34
36	36		77,7 ⁽⁹⁾		87,2 ⁽¹¹⁾	93,9*	94,0 ⁽¹¹⁾	93,7	93,7	89,9	89,9	87,4	87,4	83,1	83,1	81,2	81,2	77,1	77,1	75,4	75,4			36
38	38		69,6 ⁽⁹⁾		78,2 ⁽¹¹⁾		84,9 ⁽¹¹⁾	88,1	88,1	84,2	84,2	81,8	81,8	77,7	77,7	75,8	75,8	71,9	71,9	70,2	70,2			38
40	40		61,5 ⁽⁹⁾		68,1 ⁽¹⁰⁾		75,8 ⁽¹¹⁾	83,2	83,2	79,1	79,1	76,7	76,7	72,7	72,7	70,9	70,9	67,1	67,1	65,5	65,5			40
44	44				54,4 ⁽¹⁰⁾		59,9 ⁽¹¹⁾		66,1 ⁽¹¹⁾	70,4	70,4	67,9	67,9	64,0	64,0	62,3	62,3	58,7	58,7	57,2	57,2			44
48	48				41,4 ⁽¹⁰⁾		45,9 ⁽¹⁰⁾		52,0 ⁽¹¹⁾	59,2*	59,2	60,7	60,7	56,7	56,7	55,1	55,1	51,6	51,6	50,2	50,2			48
52	52						35,2 ⁽¹⁰⁾		38,9 ⁽¹⁰⁾		46,0 ⁽¹¹⁾	54,8	54,8	50,6	50,6	49,0	49,0	45,5	45,5	44,2	44,2			52
56	56						23,3 ⁽⁸⁾		29,8 ⁽¹⁰⁾		35,6 ⁽¹¹⁾		41,6 ⁽¹¹⁾	45,6	45,6	43,8	43,8	40,3	40,3	39,0	39,0			56
60	60						15,6 ⁽⁸⁾		20,8 ⁽¹⁰⁾		25,4 ⁽¹⁰⁾		32,0 ⁽¹¹⁾	38,0*	38,0	39,3	39,3	35,8	35,8	34,5	34,5			60
64	64										17,5 ⁽¹⁰⁾		23,5 ⁽¹¹⁾		27,0 ⁽¹¹⁾	35,7	35,7	31,9	31,9	30,5	30,5			64
68	68												16,2 ⁽¹¹⁾		19,5 ⁽¹¹⁾		24,5 ⁽¹¹⁾	28,7	28,7	27,0	27,0			68
72	72												9,0 ⁽¹¹⁾				17,4 ⁽¹¹⁾	23,0*	23,0	24,1	24,1			72
76	76																		11,7 ⁽¹⁰⁾	21,6	21,6			76
80	80																				11,6 ⁽¹¹⁾			80

1) 12° 2) 17° 3) 22° 4) 27° 5) 32° 6) 37° 7) 42° 8) 47° 9) 52° 10) 57° 11) 62°

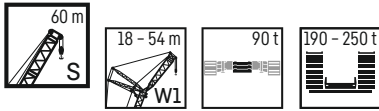

m	S 60 m														m
	W1 18 m		W1 24 m		W1 30 m		W1 36 m		W1 42 m		W1 48 m		W1 54 m		
	87/85°	WVmax	87/85°	WVmax	87/85°	WVmax	87/85°	WVmax	87/85°	WVmax	87/85°	WVmax	87/85°	WVmax	
14	274,0	274,0													14
16	241,0	241,0	231,0	231,0	221,0	221,0									16
18	215,0	215,0	206,0	206,0	197,0	197,0	190,0	190,0							18
20	193,0	193,0	186,0	186,0	178,0	178,0	172,0	172,0	165,0	165,0					20
22	176,0	176,0	169,0	169,0	161,0	161,0	156,0	156,0	149,0	149,0	145,0	145,0			22
24	162,0	162,0	154,0	154,0	147,0	147,0	142,0	142,0	136,0	136,0	133,0	133,0	128,0	128,0	24
26	141,0*	141,0	142,0	142,0	135,0	135,0	131,0	131,0	125,0	125,0	122,0	122,0	118,0	118,0	26
28		125,0 ⁽¹¹⁾	132,0	132,0	125,0	125,0	121,0	121,0	115,0	115,0	112,0	112,0	108,0	108,0	28
30		110,0 ⁽¹¹⁾	123,0	123,0	116,0	116,0	112,0	112,0	107,0	107,0	104,0	104,0	100,0	100,0	30
32		96,3 ⁽¹¹⁾	108,0*	108,0	108,0	108,0	104,0	104,0	99,0	99,0	96,4	96,4	93,0	93,0	32
34		85,5 ⁽¹¹⁾		95,1 ⁽¹¹⁾	101,0	101,0	96,9	96,9	92,2	92,2	89,7	89,7	86,5	86,5	34
36				83,9 ⁽¹¹⁾	95,7	95,7	90,7	90,7	86,1	86,1	83,7	83,7	80,6	80,6	36
38				74,3 ⁽¹¹⁾	84,3*	84,3	85,2	85,2	80,6	80,6	78,3	78,3	75,3	75,3	38
40				66,0 ⁽¹¹⁾		72,8 ⁽¹¹⁾	80,4	80,4	75,7	75,7	73,4	73,4	70,5	70,5	40
44				50,5 ⁽¹⁰⁾		56,7 ⁽¹¹⁾	67,4*	67,4	67,2	67,2	64,9	64,9	62,1	62,1	44
48				38,7 ⁽¹⁰⁾		42,2 ⁽¹⁰⁾		49,9 ⁽¹¹⁾	61,1	61,1	57,9	57,9	55,1	55,1	48
52						32,3 ⁽¹⁰⁾		38,5 ⁽¹¹⁾		43,6 ⁽¹¹⁾	52,2	52,2	49,1	49,1	52
56						22,3 ⁽¹⁰⁾		27,6 ⁽¹⁰⁾		33,1 ⁽¹¹⁾	43,6*	43,6	44,1	44,1	56
60								19,1 ⁽¹⁰⁾		14,6 ⁽⁵⁾		29,6 ⁽¹¹⁾	40,4	40,4	60
64												21,4 ⁽¹¹⁾		25,9 ⁽¹¹⁾	64
68														18,2 ⁽¹¹⁾	68

1) 12° 2) 17° 3) 22° 4) 27° 5) 32° 6) 37° 7) 42° 8) 47° 9) 52° 10) 57° 11) 62°

Hubhöhen

SW1

Lifting heights • Hauteurs de levage • Altezze di sollevamento • Alturas de elevación • Высота подъема

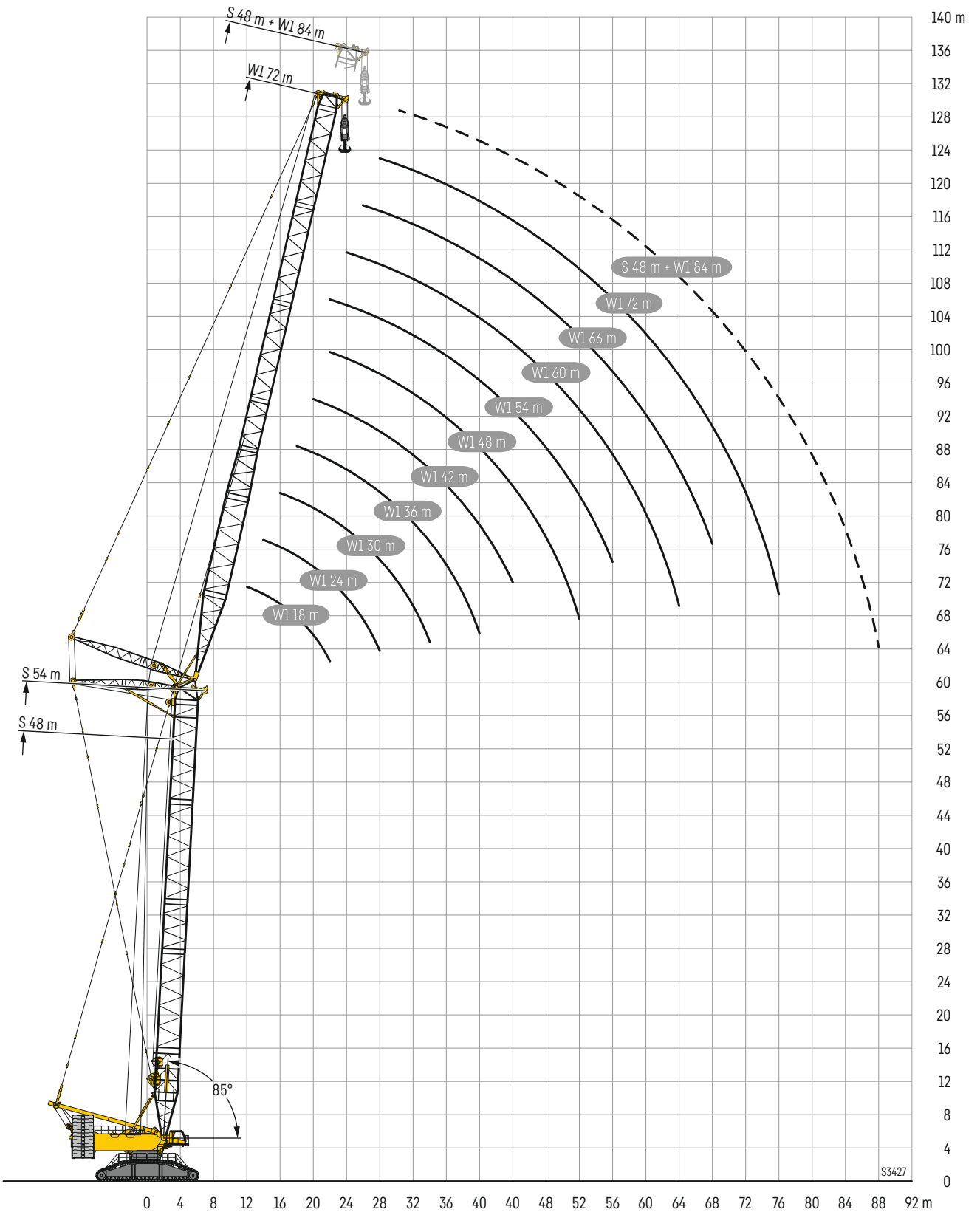

SDWB/SDWBV/SDWBW

S 42

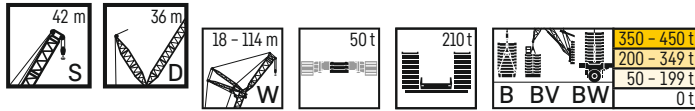

m	S 42 m																
	W 72 m		W 78 m		W 84 m		W 90 m		W 96 m		W 102 m		W 108 m		W 114 m		
	87*/85	WVmax	87*/85	WVmax	87*/85	WVmax	87*/85	WVmax	87*/85	WVmax	87*/85	WVmax	87*/85	WVmax	87*/85	WVmax	
26	B	238,0*	238,0*	212,0*	212,0*												
	BV																
	BW																
28	B	234,0*	237,0 ⁽¹⁾	209,0*	209,0*	185,0*	185,0*										
	BV																
	BW																
30	B	235,0	235,0	208,0	208,0	183,0*	184,0 ⁽¹⁾	162,0*	162,0*								
	BV																
	BW																
32	B	238,0	238,0	211,0	211,0												
	BV	232,0	232,0	206,0	206,0	183,0	183,0	160,0*	161,0 ⁽¹⁾	143,0*	143,0*	126,0*	126,0*				
	BW																
34	B	235,0	235,0	208,0	208,0	184,0	184,0										
	BV	229,0	229,0	204,0	204,0	181,0	181,0	159,0	159,0	142,0*	142,0*	125,0*	125,0*	108,0*	108,0*		
	BW																
36	B	232,0	232,0	206,0	206,0	182,0	182,0	161,0	161,0								
	BV	226,0	226,0	201,0	201,0	179,0	179,0	157,0	157,0	141,0	141,0	124,0*	124,0*	107,0*	107,0*	95,9*	95,9*
	BW																
38	B	229,0	229,0	203,0	203,0	181,0	181,0	158,0	158,0	142,0	142,0						
	BV	222,0	222,0	199,0	199,0	177,0	177,0	155,0	155,0	139,0	139,0	123,0	123,0	105,0*	106,0 ⁽¹⁾	94,3*	94,8 ⁽¹⁾
	BW																
40	B	225,0	227,0 ⁽¹⁾	201,0	201,0	179,0	179,0	156,0	156,0	141,0	141,0	124,0	124,0				
	BV	215,0	215,0	196,0	196,0	175,0	175,0	153,0	153,0	138,0	138,0	122,0	122,0	105,0	105,0	94,4	94,4
	BW																
44	B	218,0	223,0 ⁽¹⁾	199,0	199,0	177,0	177,0	154,0	154,0	139,0	139,0	123,0	123,0	105,0	105,0	94,9	94,9
	BV	191,0	199,0 ⁽²⁾	185,0	186,0 ⁽²⁾	170,0	170,0	148,0	149,0 ⁽²⁾	135,0	135,0	120,0	120,0	102,0	102,0	91,5	91,5
	BW																
48	B	192,0	214,0 ⁽²⁾	187,0	194,0 ⁽²⁾	172,0	173,0 ⁽²⁾	150,0	151,0 ⁽²⁾	136,0	136,0	120,0	120,0	103,0	103,0	91,9	91,9
	BV	169,0	182,0 ⁽³⁾	168,0	177,0 ⁽²⁾	162,0	166,0 ⁽²⁾	144,0	147,0 ⁽²⁾	132,0	133,0 ⁽²⁾	117,0	117,0	99,0	99,0	89,1	89,1
	BW																
52	B	169,0	200,0 ⁽²⁾	169,0	189,0 ⁽²⁾	163,0	170,0 ⁽²⁾	146,0	148,0 ⁽²⁾	134,0	134,0	118,0	118,0	99,6	99,6	89,5	89,5
	BV	150,0	165,0 ⁽³⁾	149,0	161,0 ⁽³⁾	147,0	156,0 ⁽²⁾	139,0	144,0 ⁽²⁾	128,0	130,0 ⁽²⁾	113,0	115,0 ⁽²⁾	96,3	96,6 ⁽²⁾	86,9	87,0 ⁽²⁾
	BW																
56	B	150,0	184,0 ⁽²⁾	149,0	176,0 ⁽²⁾	148,0	164,0 ⁽²⁾	140,0	146,0 ⁽²⁾	130,0	132,0 ⁽²⁾	114,0	116,0 ⁽²⁾	96,8	97,4 ⁽²⁾	87,4	87,4
	BV	134,0	150,0 ⁽¹⁾	133,0	147,0 ⁽³⁾	132,0	144,0 ⁽³⁾	130,0	135,0 ⁽²⁾	123,0	128,0 ⁽²⁾	109,0	112,0 ⁽²⁾	93,2	94,4 ⁽²⁾	84,8	85,5 ⁽²⁾
	BW																
60	B	134,0	171,0 ⁽²⁾	133,0	163,0 ⁽²⁾	132,0	154,0 ⁽²⁾	131,0	141,0 ⁽²⁾	124,0	130,0 ⁽²⁾	110,0	114,0 ⁽²⁾	93,8	95,4 ⁽²⁾	85,3	86,1 ⁽²⁾
	BV	121,0	137,0 ⁽¹⁾	120,0	133,0 ⁽⁴⁾	119,0	132,0 ⁽³⁾	119,0	130,0 ⁽³⁾	115,0	121,0 ⁽³⁾	105,0	109,0 ⁽²⁾	89,8	92,2 ⁽²⁾	82,3	84,0 ⁽²⁾
	BW																
64	B	121,0	160,0 ⁽²⁾	120,0	153,0 ⁽²⁾	118,0	145,0 ⁽²⁾	118,0	136,0 ⁽²⁾	115,0	125,0 ⁽²⁾	106,0	111,0 ⁽²⁾	90,5	93,4 ⁽²⁾	82,9	84,6 ⁽²⁾
	BV	111,0	124,0 ⁽¹⁾	108,0	121,0 ⁽⁴⁾	107,0	119,0 ⁽⁴⁾	107,0	119,0 ⁽³⁾	105,0	115,0 ⁽³⁾	100,0	106,0 ⁽³⁾	87,1	89,8 ⁽²⁾	79,7	82,4 ⁽²⁾
	BW																
68	B	112,0	150,0 ⁽²⁾	108,0	143,0 ⁽²⁾	107,0	136,0 ⁽²⁾	107,0	130,0 ⁽²⁾	105,0	120,0 ⁽²⁾	101,0	108,0 ⁽²⁾	87,8	91,2 ⁽²⁾	80,3	83,1 ⁽²⁾
	BV	101,0	113,0 ⁽³⁾	101,0	111,0 ⁽⁵⁾	97,4	111,0 ⁽⁴⁾	96,7	108,0 ⁽³⁾	95,3	107,0 ⁽³⁾	93,3	102,0 ⁽³⁾	84,5	87,5 ⁽³⁾	76,8	80,2 ⁽²⁾
	BW																
72	B	102,0	139,0 ⁽²⁾	101,0	134,0 ⁽²⁾	97,3	128,0 ⁽²⁾	96,6	123,0 ⁽²⁾	95,3	114,0 ⁽²⁾	94,1	104,0 ⁽²⁾	85,1	89,0 ⁽²⁾	77,4	81,1 ⁽²⁾
	BV	92,0	106,0 ⁽⁴⁾	91,6	104,0 ⁽⁵⁾	90,1	102,0 ⁽⁴⁾	87,7	99,7 ⁽⁴⁾	86,2	98,1 ⁽³⁾	86,0	94,3 ⁽²⁾	82,1	84,9 ⁽²⁾	73,6	78,6 ⁽³⁾
	BW																
76	B	92,0	129,0 ⁽²⁾	91,8	124,0 ⁽²⁾	90,1	119,0 ⁽²⁾	87,7	115,0 ⁽²⁾	86,3	108,0 ⁽²⁾	86,2	99,8 ⁽²⁾	82,0	86,7 ⁽²⁾	74,4	79,3 ⁽²⁾
	BV	79,7	98,9 ⁽⁷⁾	82,7	95,8 ⁽⁶⁾	82,3	93,3 ⁽⁴⁾	80,2	92,1 ⁽⁴⁾	78,6	90,4 ⁽³⁾	78,6	87,1 ⁽²⁾	77,2	81,8 ⁽⁴⁾	70,1	75,7 ⁽²⁾
	BW																
80	B	79,7	120,0 ⁽²⁾	83,2	115,0 ⁽²⁾	82,6	111,0 ⁽²⁾	80,3	108,0 ⁽²⁾	78,9	102,0 ⁽²⁾	78,3	95,0 ⁽²⁾	77,0	83,9 ⁽³⁾	70,8	77,1 ⁽³⁾
	BV		89,6 ⁽⁷⁾	75,6	88,1 ⁽⁶⁾	75,4	84,8 ⁽⁴⁾	74,9	84,9 ⁽⁴⁾	71,3	83,2 ⁽³⁾	72,1	81,0 ⁽⁴⁾	70,2	77,8 ⁽⁴⁾	65,9	72,9 ⁽⁴⁾
	BW																
88	B		110,0 ⁽²⁾	75,7	107,0 ⁽²⁾	75,5	103,0 ⁽²⁾	75,3	100,0 ⁽²⁾	72,2	95,1 ⁽²⁾	70,7	90,1 ⁽²⁾	70,3	81,6 ⁽³⁾	66,3	74,9 ⁽³⁾
	BV		75,1 ⁽¹¹⁾		75,9 ⁽⁹⁾	59,5	73,5 ⁽⁷⁾	62,3	72,5 ⁽⁶⁾	61,4	71,6 ⁽⁵⁾	60,5	70,1 ⁽⁴⁾	57,9	68,6 ⁽⁴⁾	56,3	65,1 ⁽³⁾
	BW																
96	B		93,8 ⁽⁵⁾		91,4 ⁽²⁾	59,3	89,0 ⁽²⁾	62,4	87,4 ⁽²⁾	61,5	82,9 ⁽²⁾	60,1	80,5 ⁽²⁾	58,3	74,2 ⁽²⁾	56,2	68,9 ⁽³⁾
	BV		59,2 ⁽⁹⁾		63,7 ⁽¹¹⁾		63,5 ⁽⁸⁾	42,1	62,3 ⁽⁶⁾	51,9	61,6 ⁽⁵⁾	51,8	60,4 ⁽⁵⁾	50,4	59,1 ⁽⁴⁾	47,2	56,7 ⁽⁴⁾
	BW																
104	B		79,8 ⁽⁷⁾		78,2 ⁽⁴⁾		77,4 ⁽⁵⁾	41,9	76,0 ⁽²⁾	51,9	73,9 ⁽²⁾	51,6	71,7 ⁽²⁾	50,5	67,7 ⁽²⁾	47,2	62,4 ⁽²⁾
	BV		43,1 ⁽⁷⁾		48,8 ⁽⁹⁾		55,3 ⁽¹¹⁾		54,7 ⁽⁹⁾		53,2 ⁽⁶⁾	41,0	52,3 ⁽⁵⁾	41,0	50,6 ⁽⁵⁾	39,5	48,9 ⁽⁴⁾
	BW																
112	B		64,8 ⁽⁷⁾		69,2 ⁽⁸⁾		67,1 ⁽⁴⁾		66,3 ⁽³⁾		64,9 ⁽²⁾	40,9	63,4 ⁽²⁾	40,9	60,5 ⁽²⁾	39,5	55,6 ⁽²⁾
	BV						39,6 ⁽⁷⁾		45,9 ⁽⁹⁾		46,1 ⁽⁹⁾		44,8 ⁽⁷⁾	31,9	43,9 ⁽⁶⁾	33,0	42,3 ⁽⁵⁾
	BW																
120	B						57,9 ⁽⁹⁾		57,3 ⁽⁵⁾		56,0 ⁽³⁾		54,9 ⁽²⁾	31,7	53,3 ⁽²⁾	33,1	48,8 ⁽²⁾
	BV								32,6 ⁽⁷⁾		37,6 ⁽⁹⁾		40,3 ⁽⁹⁾		38,2 ⁽⁷⁾	19,7	36,1 ⁽⁵⁾
	BW																
128	B						49,1 ⁽⁵⁾		49,1 ⁽⁵⁾		48,1 ⁽⁶⁾		47,4 ⁽⁵⁾		46,2 ⁽²⁾	19,7	42,4 ⁽²⁾
	BV										26,8 ⁽⁷⁾		31,3 ⁽⁹⁾		33,5 ⁽⁹⁾		30,9 ⁽⁸⁾
	BW																
136	B										41,7 ⁽⁷⁾		41,0 ⁽⁴⁾		39,4 ⁽³⁾		37,8 ⁽²⁾
	BV														23,5 ⁽⁷⁾		26,1 ⁽⁹⁾
	BW																
144	B														34,6 ⁽⁵⁾		32,8 ⁽³⁾
	BV																17,3 ⁽⁷⁾
	BW																27,5 ⁽⁶⁾

1) 12° 2) 17° 3) 22° 4) 27° 5) 32° 6) 37° 7) 42° 8) 47° 9) 52° 10) 57° 11) 62°

SDWB/SDWBV/SDWBW

S 48

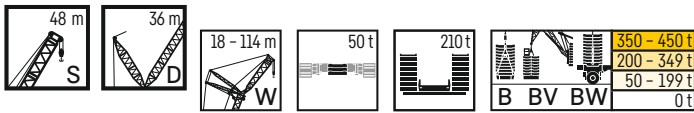

m	S 48 m																		
	W 18 m		W 24 m		W 30 m		W 36 m		W 42 m		W 48 m		W 54 m		W 60 m		W 66 m		
	87°/85	WVmax	87°/85	WVmax	87°/85	WVmax	87°/85	WVmax	87°/85	WVmax	87°/85	WVmax	87°/85	WVmax	87°/85	WVmax	87°/85	WVmax	
12	B	650,0*	650,0*																
	BV	650,0*	650,0*																
	BW	650,0	650,0																
14	B	650,0	650,0	583,0*	583,0*														
	BV	650,0	650,0	583,0*	583,0*														
	BW	650,0	650,0	588,0*	588,0*														
16	B	656,0	656,0	585,0	585,0	527,0*	527,0*	468,0*	468,0*										
	BV	656,0	656,0	585,0	585,0	527,0*	527,0*	468,0*	468,0*										
	BW	637,0	648,0 ⁽¹⁾	590,0	590,0	533,0*	533,0*	473,0*	473,0*										
18	B	531,0	587,0 ⁽²⁾	555,0	557,0 ⁽²⁾	532,0	532,0	459,0*	466,0 ⁽¹⁾	410,0*	410,0*								
	BV	531,0	587,0 ⁽²⁾	555,0	557,0 ⁽²⁾	532,0	532,0	459,0*	466,0 ⁽¹⁾	410,0*	410,0*								
	BW	533,0	646,0 ⁽¹⁾	560,0	580,0 ⁽¹⁾	539,0	539,0	464,0*	471,0 ⁽¹⁾	413,0*	413,0*								
20	B	444,0	538,0 ⁽¹⁾	472,0	520,0 ⁽²⁾	517,0	517,0	465,0	465,0	403,0*	410,0 ⁽¹⁾	360,0*	360,0*						
	BV	444,0	538,0 ⁽¹⁾	472,0	520,0 ⁽²⁾	517,0	517,0	465,0	465,0	403,0*	410,0 ⁽¹⁾	360,0*	360,0*						
	BW	444,0	642,0 ⁽¹⁾	472,0	572,0 ⁽¹⁾	526,0	526,0	471,0	472,0 ⁽¹⁾	406,0*	414,0 ⁽¹⁾	363,0*	363,0*						
22	B	379,0	491,0 ⁽²⁾	402,0	485,0 ⁽¹⁾	486,0	486,0	456,0	456,0	408,0	408,0	354,0*	362,0 ⁽¹⁾	318,0*	318,0*	285,0*	285,0*		
	BV	379,0	491,0 ⁽²⁾	402,0	485,0 ⁽¹⁾	486,0	486,0	456,0	456,0	408,0	408,0	354,0*	362,0 ⁽¹⁾	318,0*	318,0*	285,0*	285,0*		
	BW	379,0	594,0 ⁽¹⁾	403,0	563,0 ⁽¹⁾	498,0	513,0 ⁽¹⁾	462,0	472,0 ⁽¹⁾	413,0	413,0	358,0*	366,0 ⁽¹⁾	320,0*	320,0*	287,0*	287,0*		
24	B	308,0	449,0 ⁽⁴⁾	348,0	446,0 ⁽²⁾	450,0	451,0 ⁽³⁾	439,0	439,0	402,0	402,0	360,0	360,0	322,0	322,0	282,0*	284,0 ⁽¹⁾	252,0*	252,0*
	BV	308,0	449,0 ⁽⁴⁾	348,0	446,0 ⁽²⁾	450,0	451,0 ⁽³⁾	439,0	439,0	402,0	402,0	360,0	360,0	322,0	322,0	282,0*	284,0 ⁽¹⁾	252,0*	252,0*
	BW	310,0	546,0 ⁽¹⁾	349,0	535,0 ⁽¹⁾	465,0	500,0 ⁽¹⁾	453,0	471,0 ⁽¹⁾	407,0	408,0 ⁽¹⁾	365,0	366,0 ⁽¹⁾	325,0	325,0	284,0*	286,0 ⁽¹⁾	253,0*	253,0*
26	B		410,0 ⁽⁴⁾	310,0	408,0 ⁽²⁾	417,0	417,0	411,0	412,0 ⁽³⁾	395,0	395,0	355,0	355,0	318,0	318,0	285,0	285,0	249,0*	251,0 ⁽¹⁾
	BV		410,0 ⁽⁴⁾	310,0	408,0 ⁽²⁾	417,0	417,0	411,0	412,0 ⁽³⁾	395,0	395,0	355,0	355,0	318,0	318,0	285,0	285,0	249,0*	251,0 ⁽¹⁾
	BW		503,0 ⁽¹⁾	310,0	506,0 ⁽¹⁾	430,0	482,0 ⁽²⁾	431,0	470,0 ⁽¹⁾	401,0	404,0 ⁽¹⁾	360,0	364,0 ⁽¹⁾	322,0	323,0 ⁽¹⁾	288,0	288,0	251,0*	253,0 ⁽¹⁾
28	B		371,0 ⁽⁴⁾	279,0	375,0 ⁽³⁾	387,0	388,0 ⁽⁵⁾	383,0	383,0	376,0	376,0	348,0	348,0	312,0	312,0	281,0	281,0	250,0	250,0
	BV		371,0 ⁽⁴⁾	279,0	375,0 ⁽³⁾	387,0	388,0 ⁽⁵⁾	383,0	383,0	376,0	376,0	348,0	348,0	312,0	312,0	281,0	281,0	250,0	250,0
	BW		471,0 ⁽¹⁾	280,0	476,0 ⁽¹⁾	389,0	459,0 ⁽²⁾	391,0	452,0 ⁽¹⁾	381,0	399,0 ⁽¹⁾	355,0	363,0 ⁽¹⁾	318,0	321,0 ⁽¹⁾	285,0	286,0 ⁽¹⁾	254,0	254,0
30	B		342,0 ⁽¹⁾	245,0	343,0 ⁽³⁾	351,0	359,0 ⁽⁴⁾	350,0	357,0 ⁽⁴⁾	349,0	352,0 ⁽³⁾	356,0	356,0	307,0	307,0	276,0	276,0	247,0	247,0
	BV		342,0 ⁽¹⁾	245,0	343,0 ⁽³⁾	351,0	359,0 ⁽⁴⁾	350,0	357,0 ⁽⁴⁾	349,0	352,0 ⁽³⁾	356,0	356,0	307,0	307,0	276,0	276,0	247,0	247,0
	BW		439,0 ⁽¹⁾	247,0	446,0 ⁽¹⁾	350,0	434,0 ⁽³⁾	351,0	431,0 ⁽²⁾	351,0	389,0 ⁽¹⁾	342,0	361,0 ⁽¹⁾	313,0	319,0 ⁽¹⁾	281,0	284,0 ⁽¹⁾	250,0	251,0 ⁽¹⁾
32	B		316,0 ⁽⁸⁾		315,0 ⁽⁴⁾	315,0	334,0 ⁽⁶⁾	319,0	331,0 ⁽⁴⁾	318,0	327,0 ⁽³⁾	317,0	318,0 ⁽³⁾	299,0	299,0	272,0	272,0	243,0	243,0
	BV		316,0 ⁽⁸⁾		315,0 ⁽⁴⁾	315,0	334,0 ⁽⁶⁾	319,0	331,0 ⁽⁴⁾	318,0	327,0 ⁽³⁾	317,0	318,0 ⁽³⁾	299,0	299,0	272,0	272,0	243,0	243,0
	BW		409,0 ⁽²⁾		417,0 ⁽¹⁾	318,0	407,0 ⁽³⁾	320,0	405,0 ⁽²⁾	319,0	378,0 ⁽²⁾	318,0	354,0 ⁽¹⁾	304,0	317,0 ⁽¹⁾	276,0	282,0 ⁽¹⁾	247,0	249,0 ⁽¹⁾
34	B		297,0 ⁽⁸⁾		294,0 ⁽³⁾	271,0	309,0 ⁽⁷⁾	292,0	309,0 ⁽⁵⁾	291,0	305,0 ⁽⁴⁾	291,0	299,0 ⁽³⁾	285,0	286,0 ⁽³⁾	266,0	268,0 ⁽¹⁾	240,0	240,0
	BV		297,0 ⁽⁸⁾		294,0 ⁽³⁾	271,0	309,0 ⁽⁷⁾	292,0	309,0 ⁽⁵⁾	291,0	305,0 ⁽⁴⁾	291,0	299,0 ⁽³⁾	285,0	286,0 ⁽³⁾	266,0	268,0 ⁽¹⁾	240,0	240,0
	BW		380,0 ⁽²⁾		387,0 ⁽¹⁾	274,0	380,0 ⁽⁴⁾	293,0	379,0 ⁽²⁾	293,0	362,0 ⁽²⁾	292,0	341,0 ⁽²⁾	288,0	312,0 ⁽¹⁾	271,0	280,0 ⁽¹⁾	244,0	247,0 ⁽¹⁾
36	B		276,0 ⁽⁸⁾		275,0 ⁽³⁾	224,0	289,0 ⁽⁷⁾	275,0	289,0 ⁽⁵⁾	268,0	287,0 ⁽⁴⁾	268,0	280,0 ⁽³⁾	267,0	272,0 ⁽³⁾	257,0	263,0 ⁽¹⁾	237,0	238,0 ⁽¹⁾
	BV		276,0 ⁽⁸⁾		275,0 ⁽³⁾	224,0	289,0 ⁽⁷⁾	275,0	289,0 ⁽⁵⁾	268,0	287,0 ⁽⁴⁾	268,0	280,0 ⁽³⁾	267,0	272,0 ⁽³⁾	257,0	263,0 ⁽¹⁾	237,0	238,0 ⁽¹⁾
	BW		352,0 ⁽³⁾		358,0 ⁽¹⁾	226,0	357,0 ⁽¹⁾	274,0	354,0 ⁽¹⁾	270,0	346,0 ⁽¹⁾	269,0	331,0 ⁽²⁾	269,0	303,0 ⁽¹⁾	261,0	276,0 ⁽¹⁾	240,0	245,0 ⁽¹⁾
38	B		256,0 ⁽⁸⁾		257,0 ⁽⁶⁾		274,0 ⁽⁸⁾	253,0	269,0 ⁽⁵⁾	248,0	268,0 ⁽⁴⁾	248,0	263,0 ⁽⁴⁾	248,0	258,0 ⁽³⁾	245,0	252,0 ⁽¹⁾	231,0	236,0 ⁽¹⁾
	BV		256,0 ⁽⁸⁾		257,0 ⁽⁶⁾		274,0 ⁽⁸⁾	253,0	269,0 ⁽⁵⁾	248,0	268,0 ⁽⁴⁾	248,0	263,0 ⁽⁴⁾	248,0	258,0 ⁽³⁾	245,0	252,0 ⁽¹⁾	231,0	236,0 ⁽¹⁾
	BW		324,0 ⁽⁵⁾		328,0 ⁽²⁾		336,0 ⁽⁴⁾	254,0	334,0 ⁽¹⁾	249,0	330,0 ⁽¹⁾	248,0	318,0 ⁽²⁾	249,0	298,0 ⁽²⁾	247,0	268,0 ⁽²⁾	235,0	241,0 ⁽¹⁾
40	B		235,0 ⁽⁹⁾		241,0 ⁽⁷⁾		254,0 ⁽⁹⁾	231,0	254,0 ⁽⁷⁾	230,0	251,0 ⁽⁵⁾	231,0	249,0 ⁽⁴⁾	230,0	244,0 ⁽³⁾	230,0	241,0 ⁽¹⁾	225,0	228,0 ⁽¹⁾
	BV		235,0 ⁽⁹⁾		241,0 ⁽⁷⁾		254,0 ⁽⁹⁾	231,0	254,0 ⁽⁷⁾	230,0	251,0 ⁽⁵⁾	231,0	249,0 ⁽⁴⁾	230,0	244,0 ⁽³⁾	230,0	241,0 ⁽¹⁾	225,0	228,0 ⁽¹⁾
	BW		301,0 ⁽⁸⁾		306,0 ⁽²⁾		318,0 ⁽⁵⁾	231,0	317,0 ⁽²⁾	231,0	313,0 ⁽¹⁾	231,0	305,0 ⁽²⁾	231,0	286,0 ⁽²⁾	230,0	265,0 ⁽²⁾	226,0	238,0 ⁽²⁾
44	B				210,0 ⁽⁹⁾		218,0 ⁽⁸⁾		231,0 ⁽⁹⁾	204,0	227,0 ⁽⁴⁾	204,0	224,0 ⁽⁵⁾	200,0	218,0 ⁽⁴⁾	200,0	218,0 ⁽¹⁾	200,0	212,0 ⁽¹⁾
	BV				210,0 ⁽⁹⁾		218,0 ⁽⁸⁾		231,0 ⁽⁹⁾	204,0	227,0 ⁽⁴⁾	204,0	224,0 ⁽⁵⁾	200,0	218,0 ⁽⁴⁾	200,0	218,0 ⁽¹⁾	200,0	212,0 ⁽¹⁾
	BW				260,0 ⁽⁶⁾		286,0 ⁽⁴⁾		284,0 ⁽⁵⁾	205,0	282,0 ⁽²⁾	203,0	278,0 ⁽²⁾	200,0	264,0 ⁽¹⁾	200,0	248,0 ⁽²⁾	201,0	230,0 ⁽²⁾
48	B						191,0 ⁽⁹⁾		202,0 ⁽¹⁰⁾	167,0	203,0 ⁽⁸⁾	180,0	201,0 ⁽⁶⁾	176,0	197,0 ⁽⁵⁾	177,0	196,0 ⁽⁴⁾	176,0	197,0 ⁽¹⁾
	BV						191,0 ⁽⁹⁾		202,0 ⁽¹⁰⁾	167,0	203,0 ⁽⁸⁾	180,0	201,0 ⁽⁶⁾	176,0	197,0 ⁽⁵⁾	177,0	196,0 ⁽⁴⁾	176,0	197,0 ⁽¹⁾
	BW						255,0 ⁽⁷⁾		253,0 ⁽⁴⁾	169,0	253,0 ⁽³⁾	180,0	253,0 ⁽²⁾	177,0	245,0 ⁽¹⁾	176,0	229,0 ⁽²⁾	176,0	216,0 ⁽²⁾
52	B						165,0 ⁽¹⁰⁾		177,0 ⁽¹⁰⁾		181,0 ⁽¹⁰⁾	159,0	179,0 ⁽⁷⁾	159,0	177,0 ⁽⁵⁾	157,0	177,0 ⁽⁴⁾	156,0	181,0 ⁽¹⁾
	BV						165,0 ⁽¹⁰⁾		177,0 ⁽¹⁰⁾		181,0 ⁽¹⁰⁾	159,0	179,0 ⁽⁷⁾	159,0	177,0 ⁽⁵⁾	157,0	177,0 ⁽⁴⁾	156,0	181,0 ⁽¹⁾
	BW						227,0 ⁽⁷⁾		225,0 ⁽⁵⁾		226,0 ⁽³⁾	159,0	227,0 ⁽²⁾	160,0	225,0 ⁽¹⁾	157,0	213,0 ⁽²⁾	156,0	201,0 ⁽²⁾
56	B						142,0 ⁽⁵⁾		156,0 ⁽¹⁰⁾		160,0 ⁽¹⁰⁾		163,0 ⁽⁸⁾	143,0	160,0 ⁽⁶⁾	143,0	159,0 ⁽⁵⁾	141,0	165,0 ⁽¹⁾
	BV						142,0 ⁽⁵⁾		156,0 ⁽¹⁰⁾		160,0 ⁽¹⁰⁾		163,0 ⁽⁸⁾	143,0	160,0 ⁽⁶⁾	143,0	159,0 ⁽⁵⁾	141,0	165,0 ⁽¹⁾
	BW						198,0 ⁽⁴⁾		205,0 ⁽⁷⁾		204,0 ⁽⁴⁾		204,0 ⁽³⁾	143,0	206,0 ⁽¹⁾	143,0	197,0 ⁽²⁾	140,0	189,0 ⁽²⁾
60	B								134,0 ⁽⁸⁾		142,0 ⁽⁷⁾		148,0 ⁽¹⁰⁾	121,0	147,0 ⁽⁸⁾	128,0	145,0 ⁽⁶⁾	128,0	150,0 ⁽¹⁾
	BV								134,0 ⁽⁸⁾		142,0 ⁽⁷⁾		148,0 ⁽¹⁰⁾	121,0	147,0 ⁽⁸⁾	128,0	145,0 ⁽⁶⁾	128,0	150,0 ⁽¹⁾
	BW								186,0 ⁽⁸⁾		188,0 ⁽⁴⁾		185,0 ⁽³⁾	121,0	186,0 ⁽¹⁾	129,0	181,0 ⁽²⁾	128,0	176,0 ⁽²⁾
64	B																		

SDWB/SDWBV/SDWBW

S 48

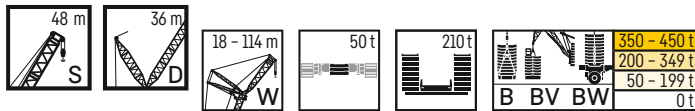

		S 48 m															
		W 72 m		W 78 m		W 84 m		W 90 m		W 96 m		W 102 m		W 108 m		W 114 m	
		87°/85	WVmax	87°/85	WVmax	87°/85	WVmax	87°/85	WVmax	87°/85	WVmax	87°/85	WVmax	87°/85	WVmax	87°/85	WVmax
26	B	223,0*	223,0*														
	BV																
	BW	224,0*	224,0*														
28	B	220,0*	222,0 ⁽¹⁾	195,0*	195,0*	175,0*	175,0*										
	BV																
	BW	222,0*	224,0 ⁽¹⁾	197,0*	197,0*	176,0*	176,0*										
30	B	221,0	221,0	193,0*	193,0*	172,0*	172,0*	153,0*	153,0*								
	BV																
	BW	223,0	223,0	194,0*	196,0 ⁽¹⁾	174,0*	174,0*	154,0*	154,0*								
32	B	218,0	218,0	193,0	193,0	170,0*	172,0 ⁽¹⁾	151,0*	152,0 ⁽¹⁾	135,0*	135,0*	120,0*	120,0*				
	BV																
	BW	221,0	222,0 ⁽¹⁾	196,0	196,0	172,0*	174,0 ⁽¹⁾	152,0*	153,0 ⁽¹⁾	135,0*	135,0*	120,0*	120,0*				
34	B	215,0	215,0	191,0	191,0	171,0	171,0	152,0	152,0	133,0*	134,0 ⁽¹⁾	118,0*	118,0*	103,0*	103,0*		
	BV																
	BW	218,0	220,0 ⁽¹⁾	194,0	194,0	173,0	173,0	153,0	153,0	134,0*	134,0*	119,0*	119,0*	104,0*	104,0*		
36	B	213,0	213,0	189,0	189,0	169,0	169,0	150,0	150,0	134,0	134,0	117,0*	117,0*	102,0*	102,0*	91,4*	91,4*
	BV																
	BW	216,0	218,0 ⁽¹⁾	192,0	192,0	171,0	171,0	151,0	151,0	134,0	134,0	117,0*	118,0 ⁽¹⁾	102,0*	102,0*	91,0*	91,0*
38	B	210,0	210,0	187,0	187,0	167,0	167,0	148,0	148,0	132,0	132,0	117,0	117,0	100,0*	101,0 ⁽¹⁾	90,1*	90,5 ⁽¹⁾
	BV																
	BW	213,0	216,0 ⁽¹⁾	189,0	189,0	169,0	169,0	149,0	149,0	133,0	133,0	117,0	117,0	101,0*	102,0 ⁽¹⁾	89,9*	90,1 ⁽¹⁾
40	B	207,0	207,0	185,0	185,0	165,0	165,0	146,0	146,0	131,0	131,0	115,0	115,0	100,0	100,0	88,9*	89,7 ⁽¹⁾
	BV																
	BW	210,0	214,0 ⁽¹⁾	187,0	188,0 ⁽²⁾	167,0	167,0	147,0	147,0	131,0	131,0	116,0	116,0	101,0	101,0	88,7*	89,4 ⁽¹⁾
44	B	197,0	199,0 ⁽²⁾	180,0	180,0	162,0	163,0 ⁽²⁾	142,0	143,0 ⁽²⁾	129,0	129,0	113,0	113,0	98,0	98,0	87,9	87,9
	BV																
	BW	198,0	209,0 ⁽²⁾	182,0	185,0 ⁽²⁾	164,0	165,0 ⁽²⁾	143,0	144,0 ⁽²⁾	129,0	129,0	114,0	114,0	98,5	98,5	87,8	87,8
48	B	176,0	185,0 ⁽²⁾	171,0	176,0 ⁽²⁾	158,0	160,0 ⁽²⁾	138,0	140,0 ⁽²⁾	126,0	127,0 ⁽²⁾	111,0	111,0	95,2	95,2	85,9	85,9
	BV																
	BW	176,0	201,0 ⁽²⁾	173,0	183,0 ⁽²⁾	160,0	163,0 ⁽²⁾	139,0	142,0 ⁽²⁾	127,0	127,0	111,0	112,0 ⁽²⁾	95,8	95,8	85,8	85,8
52	B	156,0	171,0 ⁽³⁾	154,0	163,0 ⁽³⁾	150,0	155,0 ⁽²⁾	134,0	138,0 ⁽²⁾	123,0	125,0 ⁽²⁾	108,0	109,0 ⁽²⁾	92,2	93,0 ⁽²⁾	84,0	84,0
	BV																
	BW	156,0	190,0 ⁽²⁾	154,0	175,0 ⁽²⁾	151,0	161,0 ⁽²⁾	135,0	140,0 ⁽²⁾	123,0	126,0 ⁽²⁾	109,0	110,0 ⁽²⁾	92,8	93,6 ⁽²⁾	83,9	84,0 ⁽²⁾
56	B	139,0	156,0 ⁽⁴⁾	137,0	152,0 ⁽³⁾	138,0	148,0 ⁽³⁾	130,0	133,0 ⁽²⁾	118,0	123,0 ⁽²⁾	104,0	107,0 ⁽²⁾	89,0	91,1 ⁽²⁾	82,0	82,7 ⁽²⁾
	BV																
	BW	139,0	180,0 ⁽²⁾	137,0	167,0 ⁽²⁾	139,0	155,0 ⁽²⁾	131,0	137,0 ⁽²⁾	119,0	124,0 ⁽²⁾	105,0	109,0 ⁽²⁾	89,9	91,8 ⁽²⁾	81,9	82,7 ⁽²⁾
60	B	126,0	141,0 ⁽⁴⁾	123,0	138,0 ⁽⁴⁾	124,0	138,0 ⁽³⁾	122,0	130,0 ⁽³⁾	113,0	119,0 ⁽³⁾	100,0	105,0 ⁽²⁾	86,7	89,3 ⁽²⁾	79,8	81,4 ⁽²⁾
	BV																
	BW	126,0	169,0 ⁽²⁾	124,0	159,0 ⁽²⁾	124,0	150,0 ⁽²⁾	122,0	134,0 ⁽²⁾	113,0	121,0 ⁽²⁾	101,0	107,0 ⁽²⁾	87,4	89,9 ⁽²⁾	79,6	81,4 ⁽²⁾
64	B	116,0	128,0 ⁽⁵⁾	111,0	126,0 ⁽⁴⁾	112,0	125,0 ⁽⁴⁾	110,0	122,0 ⁽³⁾	107,0	117,0 ⁽³⁾	96,1	102,0 ⁽³⁾	84,4	87,2 ⁽²⁾	77,1	80,1 ⁽²⁾
	BV																
	BW	116,0	158,0 ⁽²⁾	112,0	150,0 ⁽²⁾	112,0	143,0 ⁽²⁾	110,0	131,0 ⁽²⁾	106,0	117,0 ⁽²⁾	97,1	104,0 ⁽²⁾	85,0	88,1 ⁽²⁾	76,9	80,1 ⁽²⁾
68	B	105,0	117,0 ⁽⁵⁾	104,0	115,0 ⁽⁵⁾	101,0	116,0 ⁽⁴⁾	99,3	112,0 ⁽³⁾	99,6	109,0 ⁽³⁾	91,8	99,4 ⁽³⁾	82,1	85,3 ⁽²⁾	74,4	78,3 ⁽²⁾
	BV																
	BW	105,0	147,0 ⁽³⁾	103,0	141,0 ⁽²⁾	102,0	135,0 ⁽²⁾	99,6	125,0 ⁽²⁾	98,2	114,0 ⁽²⁾	92,9	101,0 ⁽²⁾	82,7	86,3 ⁽²⁾	74,1	78,4 ⁽²⁾
72	B	95,3	109,0 ⁽⁶⁾	94,5	107,0 ⁽⁵⁾	93,8	106,0 ⁽⁴⁾	90,0	103,0 ⁽⁴⁾	90,1	101,0 ⁽³⁾	87,0	93,1 ⁽³⁾	79,9	83,3 ⁽²⁾	71,3	76,6 ⁽²⁾
	BV																
	BW	95,6	136,0 ⁽³⁾	94,7	131,0 ⁽²⁾	93,8	127,0 ⁽²⁾	90,4	118,0 ⁽²⁾	88,5	109,0 ⁽²⁾	87,6	98,2 ⁽²⁾	80,5	84,6 ⁽²⁾	71,2	76,6 ⁽²⁾
76	B	83,7	103,0 ⁽⁷⁾	85,6	98,9 ⁽⁵⁾	85,9	98,7 ⁽⁵⁾	82,5	95,5 ⁽⁴⁾	82,5	93,7 ⁽³⁾	80,8	89,2 ⁽⁴⁾	76,9	80,8 ⁽⁴⁾	68,0	74,9 ⁽²⁾
	BV																
	BW	83,9	126,0 ⁽²⁾	85,7	122,0 ⁽²⁾	86,1	119,0 ⁽²⁾	82,5	112,0 ⁽²⁾	80,9	104,0 ⁽²⁾	80,6	94,6 ⁽²⁾	77,2	82,8 ⁽³⁾	67,8	74,8 ⁽³⁾
80	B		96,3 ⁽⁶⁾	78,0	92,3 ⁽⁶⁾	78,7	92,1 ⁽⁵⁾	76,9	88,2 ⁽⁴⁾	75,4	86,5 ⁽³⁾	73,9	83,4 ⁽⁴⁾	72,4	78,4 ⁽⁴⁾	65,1	72,3 ⁽³⁾
	BV																
	BW		116,0 ⁽²⁾	78,3	113,0 ⁽²⁾	78,8	111,0 ⁽²⁾	77,0	105,0 ⁽²⁾	74,2	98,4 ⁽²⁾	73,8	91,0 ⁽²⁾	72,2	81,2 ⁽³⁾	64,9	73,3 ⁽³⁾
88	B		79,6 ⁽¹¹⁾		79,2 ⁽⁹⁾	62,5	77,4 ⁽⁷⁾	64,1	76,0 ⁽⁶⁾	64,3	75,1 ⁽⁵⁾	61,6	72,4 ⁽⁴⁾	60,0	71,0 ⁽⁴⁾	58,8	66,8 ⁽³⁾
	BV																
	BW		98,6 ⁽³⁾		95,2 ⁽³⁾	62,7	95,0 ⁽²⁾	64,0	92,6 ⁽²⁾	63,2	87,9 ⁽²⁾	61,9	83,8 ⁽²⁾	60,0	75,1 ⁽²⁾	58,0	69,3 ⁽³⁾
96	B		62,6 ⁽⁹⁾		66,7 ⁽¹⁰⁾		67,3 ⁽⁹⁾	47,0	65,2 ⁽⁶⁾	54,1	64,6 ⁽⁵⁾	53,3	62,7 ⁽⁵⁾	51,9	61,6 ⁽⁴⁾	50,0	60,0 ⁽⁴⁾
	BV																
	BW		83,0 ⁽⁷⁾		81,6 ⁽⁴⁾		81,2 ⁽³⁾	47,0	79,5 ⁽²⁾	53,3	77,8 ⁽²⁾	53,4	76,0 ⁽²⁾	52,2	70,2 ⁽²⁾	48,8	63,1 ⁽²⁾
104	B		47,1 ⁽⁷⁾		52,8 ⁽⁹⁾		57,4 ⁽¹⁰⁾		56,2 ⁽⁹⁾		55,4 ⁽⁶⁾	42,7	53,6 ⁽⁶⁾	42,2	52,6 ⁽⁵⁾	42,1	51,8 ⁽⁵⁾
	BV																
	BW		70,5 ⁽⁷⁾		71,1 ⁽⁷⁾		70,2 ⁽⁵⁾		68,9 ⁽⁴⁾		67,7 ⁽²⁾	42,5	67,2 ⁽²⁾	42,3	63,8 ⁽²⁾	40,9	57,9 ⁽²⁾
112	B				38,4 ⁽⁷⁾		44,8 ⁽⁹⁾		49,9 ⁽¹¹⁾		48,4 ⁽⁹⁾		46,6 ⁽⁸⁾	33,3	45,4 ⁽⁶⁾	35,2	44,9 ⁽⁵⁾
	BV																
	BW				59,8 ⁽⁷⁾		62,9 ⁽⁷⁾		61,1 ⁽⁴⁾		59,9 ⁽³⁾		58,5 ⁽³⁾	33,4	57,1 ⁽²⁾	34,0	51,9 ⁽²⁾
120	B						31,8 ⁽⁷⁾		35,0 ⁽⁷⁾		40,7 ⁽⁹⁾		41,3 ⁽⁹⁾		39,7 ⁽⁷⁾	23,7	38,5 ⁽⁶⁾
	BV																
	BW						51,4 ⁽⁷⁾		53,2 ⁽⁷⁾		52,0 ⁽⁵⁾		51,3 ⁽³⁾		49,9 ⁽²⁾	23,0	45,8 ⁽²⁾
128	B										28,6 ⁽⁷⁾		33,8 ⁽⁹⁾		35,6 ⁽⁹⁾		33,7 ⁽⁷⁾
	BV																
	BW										44,3 ⁽⁷⁾		43,3 ⁽⁴⁾		41,7 ⁽²⁾		39,9 ⁽²⁾
136	B												22,5 ⁽⁷⁾		27,9 ⁽⁹⁾		29,9 ⁽⁹⁾
	BV																
	BW												37,1 ⁽⁷⁾		36,1 ⁽⁴⁾		34,6 ⁽³⁾
144	B														17,3 ⁽⁷⁾		19,2 ⁽⁷⁾
	BV																
	BW														32,1 ⁽⁷⁾		30,2 ⁽⁴⁾

1) 12° 2) 17° 3) 22° 4) 27° 5) 32° 6) 37° 7) 42° 8) 47° 9) 52° 10) 57° 11) 62°

SDWB/SDWBV/SDWBW

S 54

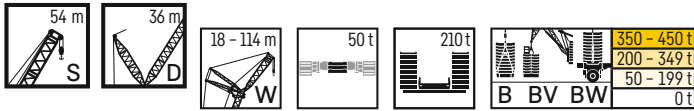

m	S 54 m																	
	W 18 m		W 24 m		W 30 m		W 36 m		W 42 m		W 48 m		W 54 m		W 60 m		W 66 m	
	87°/85	WVmax	87°/85	WVmax	87°/85	WVmax	87°/85	WVmax	87°/85	WVmax	87°/85	WVmax	87°/85	WVmax	87°/85	WVmax	87°/85	WVmax
12	B	646,0*	646,0*															
	BV	649,0*	649,0*															
	BW	616,0*	640,0 ⁽¹⁾	547,0*	547,0*													
14	B	624,0*	647,0 ⁽¹⁾	552,0*	552,0*													
	BV	620,0	620,0	529,0*	548,0 ⁽¹⁾	489,0*	489,0*											
	BW	634,0	639,0 ⁽¹⁾	534,0*	554,0 ⁽¹⁾	493,0*	493,0*											
16	B	558,0	575,0 ⁽²⁾	535,0	535,0	495,0	495,0	426,0*	431,0 ⁽¹⁾	380,0*	380,0*							
	BV	561,0	626,0 ⁽¹⁾	543,0	552,0 ⁽¹⁾	502,0	502,0	429,0*	435,0 ⁽¹⁾	383,0*	383,0*							
	BW	463,0	530,0 ⁽²⁾	506,0	506,0	485,0	485,0	432,0	432,0	373,0*	379,0 ⁽¹⁾	334,0*	334,0*					
18	B	393,0	486,0 ⁽¹⁾	435,0	472,0 ⁽²⁾	469,0	469,0	423,0	423,0	379,0	379,0	332,0*	332,0*	296,0*	296,0*	265,0*	265,0*	
	BV	393,0	584,0 ⁽¹⁾	433,0	546,0 ⁽¹⁾	480,0	489,0 ⁽¹⁾	430,0	437,0 ⁽¹⁾	384,0	384,0	332,0*	339,0 ⁽¹⁾	297,0*	297,0*	267,0*	267,0*	
	BW	322,0	446,0 ⁽²⁾	375,0	441,0 ⁽¹⁾	439,0	440,0 ⁽¹⁾	416,0	416,0	373,0	373,0	336,0	336,0	292,0*	297,0 ⁽¹⁾	263,0*	263,0*	235,0*
20	B	323,0	540,0 ⁽¹⁾	376,0	534,0 ⁽¹⁾	455,0	482,0 ⁽¹⁾	423,0	437,0 ⁽¹⁾	379,0	382,0 ⁽¹⁾	339,0	340,0 ⁽¹⁾	294,0*	300,0 ⁽¹⁾	264,0*	264,0*	236,0*
	BV	411,0 ⁽⁴⁾	330,0	407,0 ⁽³⁾	409,0	410,0 ⁽³⁾	399,0	399,0	366,0	366,0	330,0	330,0	296,0	296,0	266,0	266,0	231,0*	233,0 ⁽¹⁾
	BW	500,0 ⁽²⁾	330,0	506,0 ⁽¹⁾	425,0	471,0 ⁽¹⁾	411,0	437,0 ⁽¹⁾	373,0	381,0 ⁽¹⁾	335,0	338,0 ⁽¹⁾	300,0	300,0	269,0	269,0	233,0*	235,0 ⁽¹⁾
22	B	381,0 ⁽⁵⁾	299,0	378,0 ⁽³⁾	381,0	383,0 ⁽⁴⁾	376,0	376,0	357,0	357,0	323,0	323,0	291,0	292,0 ⁽¹⁾	262,0	262,0	234,0	234,0
	BV	461,0 ⁽¹⁾	298,0	479,0 ⁽¹⁾	393,0	458,0 ⁽²⁾	394,0	434,0 ⁽¹⁾	366,0	380,0 ⁽¹⁾	330,0	337,0 ⁽¹⁾	296,0	299,0 ⁽¹⁾	266,0	266,0	236,0	236,0
	BW	351,0 ⁽⁵⁾	255,0	351,0 ⁽⁴⁾	356,0	357,0 ⁽⁵⁾	352,0	353,0 ⁽⁴⁾	345,0	345,0	317,0	318,0 ⁽¹⁾	286,0	290,0 ⁽¹⁾	258,0	260,0 ⁽¹⁾	230,0	231,0 ⁽¹⁾
24	B	434,0 ⁽¹⁾	256,0	452,0 ⁽¹⁾	362,0	429,0 ⁽²⁾	363,0	416,0 ⁽²⁾	352,0	378,0 ⁽¹⁾	324,0	336,0 ⁽¹⁾	291,0	297,0 ⁽¹⁾	262,0	265,0 ⁽¹⁾	233,0	234,0 ⁽¹⁾
	BV	325,0 ⁽⁶⁾		325,0 ⁽⁴⁾	326,0	334,0 ⁽⁶⁾	328,0	331,0 ⁽⁴⁾	325,0	326,0 ⁽⁴⁾	310,0	313,0 ⁽¹⁾	281,0	287,0 ⁽¹⁾	253,0	258,0 ⁽¹⁾	227,0	229,0 ⁽¹⁾
	BW	406,0 ⁽¹⁾		424,0 ⁽¹⁾	330,0	402,0 ⁽³⁾	330,0	398,0 ⁽²⁾	331,0	365,0 ⁽²⁾	317,0	335,0 ⁽¹⁾	286,0	296,0 ⁽¹⁾	258,0	263,0 ⁽¹⁾	230,0	232,0 ⁽¹⁾
26	B	302,0 ⁽⁴⁾		302,0 ⁽⁵⁾	286,0	313,0 ⁽²⁾	302,0	311,0 ⁽⁵⁾	301,0	308,0 ⁽⁴⁾	296,0	296,0	275,0	284,0 ⁽¹⁾	250,0	255,0 ⁽¹⁾	223,0	227,0 ⁽¹⁾
	BV	380,0 ⁽³⁾		397,0 ⁽¹⁾	289,0	379,0 ⁽⁴⁾	301,0	374,0 ⁽²⁾	303,0	357,0 ⁽²⁾	300,0	327,0 ⁽²⁾	281,0	294,0 ⁽¹⁾	254,0	261,0 ⁽¹⁾	227,0	231,0 ⁽¹⁾
	BW	281,0 ⁽⁶⁾		281,0 ⁽⁶⁾	240,0	293,0 ⁽⁷⁾	283,0	292,0 ⁽⁵⁾	277,0	289,0 ⁽⁴⁾	277,0	281,0 ⁽⁴⁾	267,0	270,0 ⁽¹⁾	245,0	253,0 ⁽¹⁾	220,0	225,0 ⁽¹⁾
28	B	356,0 ⁽³⁾		369,0 ⁽¹⁾	242,0	355,0 ⁽⁴⁾	281,0	353,0 ⁽³⁾	278,0	341,0 ⁽²⁾	279,0	325,0 ⁽²⁾	271,0	288,0 ⁽²⁾	250,0	260,0 ⁽¹⁾	224,0	229,0 ⁽¹⁾
	BV	262,0 ⁽⁸⁾		266,0 ⁽⁶⁾		274,0 ⁽⁸⁾	261,0	274,0 ⁽⁶⁾	257,0	271,0 ⁽⁵⁾	257,0	267,0 ⁽⁴⁾	254,0	255,0 ⁽²⁾	240,0	245,0 ⁽¹⁾	217,0	223,0 ⁽¹⁾
	BW	332,0 ⁽⁴⁾		342,0 ⁽¹⁾		334,0 ⁽⁵⁾	261,0	332,0 ⁽³⁾	257,0	325,0 ⁽¹⁾	257,0	313,0 ⁽²⁾	256,0	286,0 ⁽³⁾	244,0	255,0 ⁽²⁾	221,0	228,0 ⁽¹⁾
30	B	242,0 ⁽⁹⁾		250,0 ⁽⁶⁾		259,0 ⁽⁹⁾	241,0	258,0 ⁽⁶⁾	238,0	256,0 ⁽⁵⁾	238,0	254,0 ⁽⁴⁾	238,0	245,0 ⁽³⁾	231,0	235,0 ⁽¹⁾	213,0	219,0 ⁽¹⁾
	BV	310,0 ⁽⁴⁾		315,0 ⁽³⁾		315,0 ⁽²⁾	240,0	313,0 ⁽¹⁾	238,0	310,0 ⁽¹⁾	238,0	303,0 ⁽¹⁾	239,0	281,0 ⁽²⁾	234,0	254,0 ⁽²⁾	217,0	224,0 ⁽²⁾
	BW			220,0 ⁽⁹⁾		225,0 ⁽⁹⁾		232,0 ⁽⁸⁾	211,0	229,0 ⁽⁴⁾	209,0	227,0 ⁽⁴⁾	207,0	223,0 ⁽³⁾	208,0	215,0 ⁽²⁾	200,0	210,0 ⁽²⁾
32	B			276,0 ⁽⁴⁾		284,0 ⁽⁵⁾		282,0 ⁽³⁾	211,0	281,0 ⁽¹⁾	209,0	279,0 ⁽¹⁾	207,0	265,0 ⁽²⁾	208,0	246,0 ⁽²⁾	202,0	223,0 ⁽²⁾
	BV			192,0 ⁽¹⁰⁾		198,0 ⁽¹⁰⁾		209,0 ⁽¹⁰⁾	178,0	208,0 ⁽⁸⁾	185,0	205,0 ⁽⁶⁾	182,0	201,0 ⁽⁵⁾	182,0	199,0 ⁽⁴⁾	180,0	193,0 ⁽³⁾
	BW			245,0 ⁽⁸⁾		257,0 ⁽⁸⁾		256,0 ⁽⁵⁾	179,0	255,0 ⁽³⁾	185,0	253,0 ⁽²⁾	182,0	249,0 ⁽²⁾	182,0	235,0 ⁽²⁾	180,0	215,0 ⁽²⁾
34	B			174,0 ⁽¹⁰⁾		174,0 ⁽¹⁰⁾		184,0 ⁽¹⁰⁾		189,0 ⁽¹⁰⁾	163,0	187,0 ⁽⁷⁾	164,0	183,0 ⁽⁵⁾	161,0	181,0 ⁽⁴⁾	160,0	177,0 ⁽¹⁾
	BV			231,0 ⁽⁸⁾		231,0 ⁽⁶⁾		232,0 ⁽⁶⁾		231,0 ⁽⁴⁾	164,0	230,0 ⁽³⁾	164,0	228,0 ⁽²⁾	162,0	222,0 ⁽²⁾	160,0	207,0 ⁽²⁾
	BW			148,0 ⁽⁸⁾		164,0 ⁽¹⁰⁾		167,0 ⁽¹⁰⁾		167,0 ⁽¹⁰⁾		169,0 ⁽⁸⁾	147,0	167,0 ⁽⁶⁾	148,0	164,0 ⁽⁵⁾	143,0	163,0 ⁽¹⁾
36	B			205,0 ⁽⁸⁾		209,0 ⁽⁶⁾		209,0 ⁽⁴⁾		209,0 ⁽⁴⁾		209,0 ⁽³⁾	147,0	208,0 ⁽²⁾	148,0	206,0 ⁽²⁾	143,0	196,0 ⁽²⁾
	BV			129,0 ⁽⁸⁾		144,0 ⁽¹⁰⁾		148,0 ⁽¹⁰⁾		148,0 ⁽¹⁰⁾		153,0 ⁽⁹⁾	126,0	151,0 ⁽⁸⁾	133,0	149,0 ⁽⁶⁾	131,0	149,0 ⁽¹⁾
	BW			182,0 ⁽⁸⁾		190,0 ⁽⁸⁾		189,0 ⁽⁴⁾		189,0 ⁽⁴⁾		190,0 ⁽⁴⁾	126,0	189,0 ⁽³⁾	133,0	189,0 ⁽²⁾	132,0	183,0 ⁽²⁾
38	B					123,0 ⁽⁸⁾		130,0 ⁽¹⁰⁾		130,0 ⁽¹⁰⁾		139,0 ⁽¹⁰⁾		138,0 ⁽⁷⁾	117,0	135,0 ⁽⁸⁾	118,0	135,0 ⁽¹⁾
	BV					171,0 ⁽⁸⁾		174,0 ⁽⁷⁾		174,0 ⁽⁷⁾		173,0 ⁽⁴⁾		172,0 ⁽³⁾	117,0	172,0 ⁽²⁾	119,0	170,0 ⁽²⁾
	BW					106,0 ⁽⁸⁾		112,0 ⁽⁸⁾		112,0 ⁽⁸⁾		125,0 ⁽¹⁰⁾		125,0 ⁽⁷⁾		125,0 ⁽⁸⁾	106,0	122,0 ⁽⁶⁾
40	B					152,0 ⁽⁸⁾		160,0 ⁽⁸⁾		160,0 ⁽⁸⁾		160,0 ⁽⁶⁾		159,0 ⁽⁴⁾		159,0 ⁽³⁾	107,0	157,0 ⁽²⁾
	BV					99,6 ⁽⁸⁾		99,6 ⁽⁸⁾		99,6 ⁽⁸⁾		110,0 ⁽¹⁰⁾		115,0 ⁽¹¹⁾		115,0 ⁽⁹⁾	90,3	113,0 ⁽⁷⁾
	BW							141,0 ⁽⁸⁾		141,0 ⁽⁸⁾		150,0 ⁽⁸⁾		148,0 ⁽⁵⁾		147,0 ⁽³⁾	90,3	144,0 ⁽²⁾
42	B											94,5 ⁽⁹⁾		104,0 ⁽¹¹⁾		109,0 ⁽¹¹⁾		107,0 ⁽⁸⁾
	BV											135,0 ⁽⁸⁾		138,0 ⁽⁶⁾		136,0 ⁽⁴⁾		133,0 ⁽³⁾
	BW											80,8 ⁽⁹⁾		91,2 ⁽⁹⁾		96,9 ⁽¹¹⁾		99,8 ⁽¹⁰⁾
44	B											119,0 ⁽⁸⁾		127,0 ⁽⁹⁾		125,0 ⁽⁶⁾		124,0 ⁽⁴⁾
	BV											59,1 ⁽⁷⁾		64,2 ⁽⁷⁾		73,3 ⁽⁷⁾		81,2 ⁽¹⁾
	BW											92,8 ⁽⁷⁾		99,5 ⁽⁷⁾		106,0 ⁽⁸⁾		104,0 ⁽⁴⁾
46	B															54,7 ⁽⁷⁾		61,8 ⁽⁹⁾
	BV															84,2 ⁽⁷⁾		87,3 ⁽⁹⁾
	BW																	45,4 ⁽⁷⁾
48	B																	68,9 ⁽⁷⁾

1) 12° 2) 17° 3) 22° 4) 27° 5) 32° 6) 37° 7) 42° 8) 47° 9) 52° 10) 57° 11) 62°

SDWB/SDWBV/SDWBW

S 54

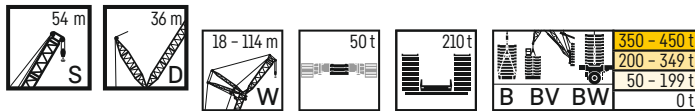

m	S	S 54 m															
		W 72 m		W 78 m		W 84 m		W 90 m		W 96 m		W 102 m		W 108 m		W 114 m	
		87°/85	WVmax	87°/85	WVmax	87°/85	WVmax	87°/85	WVmax	87°/85	WVmax	87°/85	WVmax	87°/85	WVmax	87°/85	WVmax
26	B	208,0*	208,0*														
	BV																
	BW	209,0*	209,0*														
28	B	204,0*	207,0 ⁽¹⁾	182,0*	182,0*	163,0*	163,0*										
	BV																
	BW	206,0*	208,0 ⁽¹⁾	183,0*	183,0*	165,0*	165,0*										
30	B	206,0	206,0	179,0*	181,0 ⁽¹⁾	161,0*	161,0*	144,0*	144,0*								
	BV																
	BW	208,0	208,0	181,0*	183,0 ⁽¹⁾	162,0*	162,0*	145,0*	145,0*								
32	B	204,0	204,0	181,0	181,0	159,0*	161,0 ⁽¹⁾	143,0*	143,0*	127,0*	127,0*						
	BV																
	BW	206,0	206,0	182,0	182,0	160,0*	162,0 ⁽¹⁾	143,0*	144,0 ⁽¹⁾	128,0*	128,0*						
34	B	201,0	202,0 ⁽¹⁾	179,0	179,0	160,0	160,0	141,0*	142,0 ⁽¹⁾	126,0*	126,0*	111,0*	111,0*	98,3*	98,3*		
	BV																
	BW	204,0	205,0 ⁽¹⁾	181,0	181,0	161,0	161,0	142,0*	143,0 ⁽¹⁾	126,0*	127,0 ⁽¹⁾	111,0*	111,0*	98,6*	98,6*		
36	B	199,0	201,0 ⁽¹⁾	177,0	177,0	158,0	158,0	141,0	141,0	126,0	126,0	110,0*	110,0*	97,0*	97,0*	86,6*	86,6*
	BV																
	BW	201,0	204,0 ⁽¹⁾	179,0	179,0	160,0	160,0	143,0	143,0	127,0	127,0	110,0*	111,0 ⁽¹⁾	97,3*	97,3*	86,9*	86,9*
38	B	196,0	199,0 ⁽¹⁾	175,0	175,0	157,0	157,0	140,0	140,0	125,0	125,0	110,0	110,0	95,6*	96,3 ⁽¹⁾	85,7*	85,7*
	BV																
	BW	199,0	202,0 ⁽¹⁾	177,0	177,0	158,0	158,0	141,0	141,0	126,0	126,0	110,0	110,0	96,0*	96,6 ⁽¹⁾	85,9*	85,9*
40	B	193,0	198,0 ⁽¹⁾	173,0	173,0	155,0	155,0	138,0	138,0	124,0	124,0	109,0	109,0	95,8	95,8	84,7*	85,3 ⁽¹⁾
	BV																
	BW	196,0	201,0 ⁽¹⁾	175,0	176,0 ⁽²⁾	157,0	157,0	140,0	140,0	125,0	125,0	109,0	109,0	96,2	96,2	85,0*	85,6 ⁽¹⁾
44	B	187,0	192,0 ⁽²⁾	168,0	171,0 ⁽²⁾	152,0	153,0 ⁽²⁾	135,0	135,0	121,0	121,0	107,0	107,0	92,9	92,9	83,9	83,9
	BV																
	BW	190,0	198,0 ⁽²⁾	171,0	174,0 ⁽²⁾	154,0	155,0 ⁽²⁾	136,0	136,0	123,0	123,0	108,0	108,0	94,1	94,1	84,3	84,3
48	B	177,0	185,0 ⁽²⁾	163,0	169,0 ⁽²⁾	148,0	151,0 ⁽²⁾	131,0	134,0 ⁽²⁾	119,0	119,0	105,0	105,0	90,4	90,4	82,2	82,2
	BV																
	BW	179,0	195,0 ⁽²⁾	165,0	173,0 ⁽²⁾	150,0	154,0 ⁽²⁾	133,0	135,0 ⁽²⁾	120,0	121,0 ⁽²⁾	106,0	106,0	91,2	91,2	82,6	82,6
52	B	160,0	171,0 ⁽³⁾	155,0	160,0 ⁽²⁾	143,0	150,0 ⁽²⁾	128,0	132,0 ⁽²⁾	116,0	118,0 ⁽²⁾	102,0	103,0 ⁽²⁾	88,1	88,5 ⁽²⁾	80,3	80,3
	BV																
	BW	160,0	190,0 ⁽²⁾	156,0	170,0 ⁽²⁾	145,0	152,0 ⁽²⁾	129,0	134,0 ⁽²⁾	117,0	120,0 ⁽²⁾	103,0	104,0 ⁽²⁾	88,6	89,1 ⁽²⁾	80,8	80,8
56	B	143,0	159,0 ⁽⁴⁾	140,0	155,0 ⁽³⁾	135,0	145,0 ⁽³⁾	124,0	129,0 ⁽²⁾	111,0	116,0 ⁽²⁾	98,9	102,0 ⁽²⁾	85,6	87,1 ⁽²⁾	78,6	79,2 ⁽²⁾
	BV																
	BW	143,0	184,0 ⁽⁴⁾	140,0	165,0 ⁽²⁾	137,0	149,0 ⁽²⁾	125,0	132,0 ⁽⁴⁾	113,0	118,0 ⁽²⁾	100,0	103,0 ⁽²⁾	86,3	87,9 ⁽²⁾	79,1	79,7 ⁽²⁾
60	B	128,0	146,0 ⁽⁴⁾	127,0	141,0 ⁽⁴⁾	126,0	139,0 ⁽³⁾	119,0	127,0 ⁽³⁾	107,0	113,0 ⁽²⁾	94,9	100,0 ⁽²⁾	83,4	85,7 ⁽²⁾	76,3	78,0 ⁽²⁾
	BV																
	BW	128,0	174,0 ⁽²⁾	126,0	161,0 ⁽²⁾	126,0	146,0 ⁽²⁾	120,0	130,0 ⁽²⁾	108,0	116,0 ⁽²⁾	95,9	102,0 ⁽²⁾	84,0	86,5 ⁽²⁾	76,9	78,6 ⁽²⁾
64	B	119,0	132,0 ⁽⁵⁾	114,0	130,0 ⁽⁴⁾	114,0	128,0 ⁽⁴⁾	112,0	122,0 ⁽⁵⁾	102,0	112,0 ⁽⁵⁾	90,6	97,6 ⁽²⁾	81,2	84,3 ⁽²⁾	73,5	76,8 ⁽²⁾
	BV																
	BW	119,0	162,0 ⁽²⁾	114,0	153,0 ⁽²⁾	114,0	142,0 ⁽²⁾	112,0	128,0 ⁽²⁾	104,0	114,0 ⁽²⁾	91,7	99,5 ⁽²⁾	81,8	85,1 ⁽²⁾	74,2	77,5 ⁽²⁾
68	B	107,0	121,0 ⁽⁵⁾	105,0	118,0 ⁽⁴⁾	104,0	119,0 ⁽⁴⁾	102,0	114,0 ⁽⁴⁾	97,7	107,0 ⁽³⁾	86,8	95,2 ⁽³⁾	78,9	82,7 ⁽²⁾	70,3	75,2 ⁽²⁾
	BV																
	BW	107,0	151,0 ⁽³⁾	106,0	144,0 ⁽²⁾	104,0	135,0 ⁽²⁾	102,0	124,0 ⁽³⁾	99,1	111,0 ⁽²⁾	87,8	97,2 ⁽²⁾	79,7	83,5 ⁽²⁾	71,0	76,2 ⁽²⁾
72	B	97,5	112,0 ⁽⁶⁾	96,2	110,0 ⁽⁵⁾	94,8	109,0 ⁽⁴⁾	91,9	106,0 ⁽⁴⁾	91,6	103,0 ⁽⁴⁾	83,3	91,7 ⁽²⁾	76,3	81,1 ⁽²⁾	67,2	73,5 ⁽²⁾
	BV																
	BW	97,6	140,0 ⁽²⁾	96,6	136,0 ⁽²⁾	95,5	129,0 ⁽²⁾	92,3	119,0 ⁽²⁾	92,2	108,0 ⁽²⁾	84,4	94,9 ⁽⁵⁾	77,1	81,9 ⁽²⁾	67,8	74,6 ⁽²⁾
76	B	86,5	104,0 ⁽⁷⁾	87,6	102,0 ⁽⁵⁾	87,5	101,0 ⁽⁵⁾	84,0	98,1 ⁽⁶⁾	84,1	94,9 ⁽³⁾	79,7	88,2 ⁽⁴⁾	73,5	79,5 ⁽²⁾	64,5	71,8 ⁽²⁾
	BV																
	BW	86,7	130,0 ⁽³⁾	87,5	128,0 ⁽²⁾	87,8	122,0 ⁽²⁾	84,2	114,0 ⁽²⁾	84,7	104,0 ⁽³⁾	80,7	92,8 ⁽³⁾	74,1	80,4 ⁽³⁾	65,2	73,0 ⁽²⁾
80	B		98,2 ⁽⁶⁾	80,0	95,7 ⁽⁶⁾	80,3	95,0 ⁽⁵⁾	78,0	90,4 ⁽⁴⁾	77,2	88,1 ⁽⁵⁾	74,8	83,4 ⁽⁴⁾	69,6	77,3 ⁽⁵⁾	62,0	69,6 ⁽²⁾
	BV																
	BW		122,0 ⁽³⁾	79,6	119,0 ⁽²⁾	80,5	116,0 ⁽²⁾	78,2	109,0 ⁽²⁾	77,4	99,9 ⁽²⁾	75,5	90,8 ⁽³⁾	70,5	79,1 ⁽³⁾	62,7	71,3 ⁽²⁾
88	B		82,9 ⁽¹¹⁾		80,3 ⁽⁹⁾	64,3	79,7 ⁽⁷⁾	65,4	78,0 ⁽⁶⁾	65,9	76,7 ⁽⁵⁾	63,1	73,7 ⁽⁵⁾	61,4	70,7 ⁽⁴⁾	57,3	66,0 ⁽³⁾
	BV																
	BW		102,0 ⁽⁴⁾		101,0 ⁽³⁾	64,8	101,0 ⁽²⁾	65,5	98,2 ⁽²⁾	66,0	92,1 ⁽²⁾	63,2	83,7 ⁽²⁾	61,3	74,9 ⁽³⁾	58,1	67,7 ⁽³⁾
96	B		67,4 ⁽¹¹⁾		69,6 ⁽¹⁰⁾		70,1 ⁽⁹⁾	50,0	67,4 ⁽⁶⁾	55,7	66,5 ⁽⁶⁾	54,5	64,7 ⁽⁵⁾	53,4	62,8 ⁽⁵⁾	51,5	61,3 ⁽⁴⁾
	BV																
	BW		86,7 ⁽⁸⁾		84,9 ⁽⁴⁾		84,6 ⁽⁵⁾	50,1	83,9 ⁽²⁾	55,6	82,3 ⁽²⁾	54,6	78,0 ⁽²⁾	53,5	70,4 ⁽²⁾	51,6	63,3 ⁽³⁾
104	B		51,1 ⁽⁸⁾		55,9 ⁽⁹⁾		59,4 ⁽⁹⁾		58,3 ⁽⁸⁾		57,2 ⁽⁸⁾	43,9	55,2 ⁽⁴⁾	43,4	54,7 ⁽⁵⁾	43,3	53,8 ⁽⁵⁾
	BV																
	BW		75,0 ⁽⁹⁾		73,5 ⁽⁸⁾		72,6 ⁽⁵⁾		71,5 ⁽³⁾		71,3 ⁽³⁾	44,1	68,9 ⁽²⁾	43,4	65,0 ⁽²⁾	44,6	59,0 ⁽³⁾
112	B		37,6 ⁽⁷⁾		40,6 ⁽⁷⁾		47,7 ⁽⁹⁾		50,2 ⁽⁹⁾		49,9 ⁽⁹⁾		48,0 ⁽⁸⁾	34,6	46,9 ⁽⁶⁾	36,4	46,4 ⁽⁵⁾
	BV																
	BW		58,9 ⁽⁷⁾		63,3 ⁽⁷⁾		64,1 ⁽⁴⁾		62,7 ⁽⁴⁾		62,1 ⁽³⁾		60,5 ⁽³⁾	34,7	58,2 ⁽²⁾	36,3	54,6 ⁽³⁾
120	B						34,1 ⁽⁷⁾		39,5 ⁽⁹⁾		43,1 ⁽¹¹⁾		42,0 ⁽⁹⁾		40,6 ⁽⁷⁾	25,6	40,0 ⁽⁶⁾
	BV																
	BW						54,5 ⁽⁷⁾		56,5 ⁽⁶⁾		55,1 ⁽⁵⁾		53,4 ⁽⁵⁾		51,7 ⁽³⁾	25,7	49,0 ⁽³⁾
128	B								27,0 ⁽⁶⁾		32,6 ⁽⁹⁾		35,7 ⁽⁹⁾		35,9 ⁽⁶⁾		34,3 ⁽⁷⁾
	BV																
	BW								46,0 ⁽⁷⁾		48,6 ⁽⁸⁾		46,9 ⁽⁴⁾		45,4 ⁽³⁾		43,4 ⁽³⁾
136	B										21,3 ⁽⁷⁾		24,8 ⁽⁷⁾		29,1 ⁽⁹⁾		29,8 ⁽⁹⁾
	BV																
	BW										38,5 ⁽⁷⁾		38,9 ⁽⁷⁾		37,9 ⁽⁴⁾		37,4 ⁽⁴⁾
144	B														18,8 ⁽⁷⁾		22,4 ⁽⁹⁾
	BV																
	BW														32,5 ⁽⁷⁾		31,6 ⁽⁵⁾
152	B																13,4 ⁽⁷⁾
	BV																
	BW																27,1 ⁽⁷⁾

1) 12° 2) 17° 3) 22° 4) 27° 5) 32° 6) 37° 7) 42° 8) 47° 9) 52° 10) 57° 11) 62°

SDWB/SDWBV/SDWBW

S 60

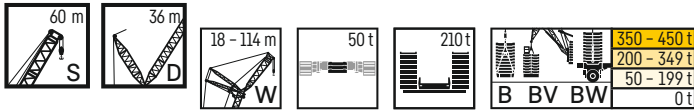

m	S 60 m																		
	W 18 m		W 24 m		W 30 m		W 36 m		W 42 m		W 48 m		W 54 m		W 60 m		W 66 m		
	87°/85	WVmax	87°/85	WVmax	87°/85	WVmax	87°/85	WVmax	87°/85	WVmax	87°/85	WVmax	87°/85	WVmax	87°/85	WVmax	87°/85	WVmax	
14	B	555,0*	575,0 ⁽¹⁾	505,0*	505,0*														
	BV	563,0*	585,0 ⁽¹⁾	511,0*	511,0*														
	BW	568,0	568,0	484,0*	505,0 ⁽¹⁾	446,0*	446,0*												
16	B	580,0	586,0 ⁽¹⁾	491,0*	512,0 ⁽¹⁾	452,0*	452,0*												
	BV	541,0	541,0	497,0	497,0	430,0*	451,0 ⁽¹⁾	393,0*	393,0*	352,0*	352,0*								
	BW	553,0	580,0 ⁽¹⁾	506,0	513,0 ⁽¹⁾	436,0*	459,0 ⁽¹⁾	396,0*	396,0*	354,0*	354,0*								
18	B	485,0	507,0 ⁽³⁾	474,0	474,0	444,0	444,0	400,0	400,0	346,0*	351,0 ⁽¹⁾	311,0*	311,0*						
	BV	485,0	574,0 ⁽¹⁾	482,0	512,0 ⁽¹⁾	453,0	461,0 ⁽¹⁾	406,0	406,0	349,0*	353,0 ⁽¹⁾	312,0*	312,0*						
	BW	409,0	476,0 ⁽¹⁾	445,0	452,0 ⁽¹⁾	428,0	428,0	393,0	393,0	353,0	353,0	306,0*	311,0 ⁽¹⁾	274,0*	274,0*				
22	B	410,0	567,0 ⁽¹⁾	450,0	511,0 ⁽¹⁾	439,0	462,0 ⁽¹⁾	399,0	404,0 ⁽¹⁾	357,0	357,0	307,0*	313,0 ⁽¹⁾	276,0*	276,0*				
	BV	346,0	440,0 ⁽¹⁾	391,0	431,0 ⁽¹⁾	412,0	412,0	382,0	382,0	347,0	347,0	312,0	312,0	270,0*	275,0 ⁽¹⁾	243,0*	243,0*	219,0*	219,0*
	BW	348,0	532,0 ⁽²⁾	392,0	511,0 ⁽¹⁾	423,0	462,0 ⁽¹⁾	390,0	404,0 ⁽¹⁾	352,0	355,0 ⁽¹⁾	315,0	315,0	272,0*	277,0 ⁽¹⁾	245,0*	245,0*	220,0*	220,0*
24	B	255,0	406,0 ⁽³⁾	343,0	402,0 ⁽¹⁾	395,0	395,0	368,0	369,0 ⁽¹⁾	339,0	340,0 ⁽¹⁾	307,0	308,0 ⁽¹⁾	275,0	275,0	240,0*	244,0 ⁽¹⁾	216,0*	217,0 ⁽¹⁾
	BV	257,0	495,0 ⁽²⁾	342,0	489,0 ⁽¹⁾	407,0	463,0 ⁽¹⁾	379,0	404,0 ⁽¹⁾	346,0	355,0 ⁽¹⁾	311,0	313,0 ⁽¹⁾	278,0	278,0	242,0*	247,0 ⁽¹⁾	217,0*	219,0 ⁽¹⁾
	BW		377,0 ⁽⁴⁾	308,0	373,0 ⁽²⁾	374,0	374,0	353,0	359,0 ⁽¹⁾	329,0	334,0 ⁽¹⁾	301,0	305,0 ⁽¹⁾	270,0	272,0 ⁽¹⁾	243,0	243,0	212,0*	216,0 ⁽¹⁾
28	B	458,0 ⁽²⁾	308,0	465,0 ⁽¹⁾	381,0	443,0 ⁽¹⁾	366,0	404,0 ⁽¹⁾	339,0	354,0 ⁽¹⁾	307,0	313,0 ⁽¹⁾	275,0	277,0 ⁽¹⁾	247,0	247,0	214,0*	219,0 ⁽¹⁾	
	BV	351,0 ⁽⁶⁾	269,0	348,0 ⁽³⁾	348,0	351,0 ⁽⁵⁾	339,0	341,0 ⁽¹⁾	318,0	329,0 ⁽¹⁾	295,0	302,0 ⁽¹⁾	265,0	270,0 ⁽¹⁾	240,0	241,0 ⁽¹⁾	215,0	215,0	
	BW	424,0 ⁽⁵⁾	270,0	441,0 ⁽¹⁾	354,0	421,0 ⁽²⁾	350,0	393,0 ⁽²⁾	328,0	354,0 ⁽¹⁾	300,0	312,0 ⁽¹⁾	270,0	276,0 ⁽¹⁾	244,0	246,0 ⁽¹⁾	218,0	218,0	
30	B	325,0 ⁽⁷⁾	207,0	326,0 ⁽⁵⁾	321,0	329,0 ⁽⁶⁾	324,0	324,0	305,0	316,0 ⁽³⁾	286,0	299,0 ⁽¹⁾	261,0	268,0 ⁽¹⁾	236,0	239,0 ⁽¹⁾	212,0	214,0 ⁽¹⁾	
	BV	389,0 ⁽⁵⁾	208,0	416,0 ⁽¹⁾	325,0	396,0 ⁽²⁾	334,0	388,0 ⁽²⁾	315,0	348,0 ⁽¹⁾	293,0	311,0 ⁽¹⁾	266,0	274,0 ⁽¹⁾	240,0	244,0 ⁽¹⁾	215,0	217,0 ⁽¹⁾	
	BW	301,0 ⁽⁸⁾		305,0 ⁽⁵⁾	290,0	309,0 ⁽⁶⁾	306,0	306,0	295,0	297,0 ⁽²⁾	277,0	291,0 ⁽¹⁾	255,0	265,0 ⁽¹⁾	232,0	238,0 ⁽¹⁾	209,0	212,0 ⁽¹⁾	
34	B	331,0 ⁽⁸⁾		392,0 ⁽¹⁾	293,0	373,0 ⁽⁴⁾	314,0	367,0 ⁽²⁾	303,0	344,0 ⁽²⁾	284,0	307,0 ⁽¹⁾	260,0	273,0 ⁽¹⁾	236,0	243,0 ⁽¹⁾	212,0	216,0 ⁽¹⁾	
	BV			285,0 ⁽⁶⁾	244,0	289,0 ⁽⁷⁾	290,0	290,0	283,0	283,0	267,0	274,0 ⁽¹⁾	248,0	261,0 ⁽¹⁾	227,0	236,0 ⁽¹⁾	206,0	211,0 ⁽¹⁾	
	BW			368,0 ⁽¹⁾	248,0	353,0 ⁽⁵⁾	297,0	348,0 ⁽³⁾	289,0	331,0 ⁽²⁾	274,0	305,0 ⁽²⁾	254,0	270,0 ⁽¹⁾	232,0	242,0 ⁽¹⁾	209,0	214,0 ⁽¹⁾	
36	B			266,0 ⁽⁶⁾	190,0	271,0 ⁽⁷⁾	275,0	275,0	268,0	269,0 ⁽⁴⁾	258,0	262,0 ⁽²⁾	239,0	249,0 ⁽²⁾	223,0	234,0 ⁽¹⁾	203,0	209,0 ⁽¹⁾	
	BV			344,0 ⁽¹⁾	192,0	333,0 ⁽⁵⁾	278,0	330,0 ⁽⁴⁾	272,0	324,0 ⁽³⁾	264,0	299,0 ⁽²⁾	247,0	268,0 ⁽²⁾	228,0	240,0 ⁽¹⁾	206,0	213,0 ⁽¹⁾	
	BW			250,0 ⁽⁸⁾		256,0 ⁽⁸⁾	246,0	260,0 ⁽⁸⁾	253,0	256,0 ⁽⁴⁾	249,0	249,0	232,0	243,0 ⁽²⁾	218,0	227,0 ⁽²⁾	199,0	207,0 ⁽¹⁾	
40	B			319,0 ⁽¹⁾		313,0 ⁽⁵⁾	248,0	313,0 ⁽⁵⁾	255,0	308,0 ⁽³⁾	251,0	296,0 ⁽³⁾	239,0	267,0 ⁽²⁾	223,0	237,0 ⁽²⁾	203,0	212,0 ⁽¹⁾	
	BV			223,0 ⁽¹⁰⁾		229,0 ⁽⁹⁾	164,0	231,0 ⁽⁶⁾	224,0	230,0 ⁽⁴⁾	222,0	227,0 ⁽⁶⁾	216,0	221,0 ⁽³⁾	204,0	215,0 ⁽²⁾	190,0	202,0 ⁽²⁾	
	BW			279,0 ⁽⁴⁾		280,0 ⁽⁴⁾	166,0	281,0 ⁽⁵⁾	224,0	280,0 ⁽⁴⁾	220,0	274,0 ⁽³⁾	218,0	260,0 ⁽³⁾	210,0	234,0 ⁽²⁾	195,0	209,0 ⁽²⁾	
44	B			195,0 ⁽¹⁰⁾		203,0 ⁽¹⁰⁾		208,0 ⁽¹⁰⁾	181,0	208,0 ⁽⁸⁾	198,0	207,0 ⁽⁶⁾	193,0	202,0 ⁽⁴⁾	190,0	198,0 ⁽³⁾	181,0	188,0 ⁽²⁾	
	BV			247,0 ⁽⁵⁾		254,0 ⁽⁸⁾		253,0 ⁽⁴⁾	183,0	251,0 ⁽²⁾	197,0	249,0 ⁽¹⁾	193,0	243,0 ⁽²⁾	193,0	229,0 ⁽³⁾	185,0	206,0 ⁽²⁾	
	BW			180,0 ⁽¹⁰⁾		180,0 ⁽¹⁰⁾		184,0 ⁽¹⁰⁾		189,0 ⁽⁹⁾	168,0	188,0 ⁽⁷⁾	173,0	185,0 ⁽⁵⁾	172,0	183,0 ⁽⁴⁾	168,0	175,0 ⁽³⁾	
52	B					230,0 ⁽⁸⁾		231,0 ⁽⁸⁾		230,0 ⁽⁵⁾	167,0	228,0 ⁽³⁾	174,0	225,0 ⁽²⁾	172,0	222,0 ⁽²⁾	171,0	203,0 ⁽²⁾	
	BV					158,0 ⁽¹⁰⁾		163,0 ⁽⁹⁾		171,0 ⁽¹⁰⁾	126,0	172,0 ⁽⁹⁾	154,0	169,0 ⁽⁷⁾	157,0	167,0 ⁽⁶⁾	153,0	163,0 ⁽⁴⁾	
	BW					206,0 ⁽⁸⁾		211,0 ⁽⁸⁾		212,0 ⁽⁷⁾	126,0	209,0 ⁽⁵⁾	153,0	207,0 ⁽³⁾	157,0	206,0 ⁽²⁾	154,0	198,0 ⁽²⁾	
60	B					144,0 ⁽¹⁰⁾		144,0 ⁽¹⁰⁾		152,0 ⁽¹⁰⁾		158,0 ⁽⁹⁾	127,0	157,0 ⁽⁸⁾	138,0	155,0 ⁽⁶⁾	141,0	152,0 ⁽⁵⁾	
	BV							191,0 ⁽⁹⁾		194,0 ⁽⁷⁾		193,0 ⁽⁵⁾	127,0	191,0 ⁽⁴⁾	138,0	190,0 ⁽³⁾	142,0	184,0 ⁽²⁾	
	BW							123,0 ⁽⁸⁾		136,0 ⁽¹⁰⁾		142,0 ⁽¹⁰⁾		144,0 ⁽⁹⁾	117,0	143,0 ⁽⁸⁾	126,0	142,0 ⁽⁶⁾	
64	B							171,0 ⁽⁸⁾		177,0 ⁽⁸⁾		176,0 ⁽⁵⁾		175,0 ⁽⁴⁾	117,0	175,0 ⁽³⁾	126,0	172,0 ⁽³⁾	
	BV							109,0 ⁽⁸⁾		120,0 ⁽¹⁰⁾		129,0 ⁽¹⁰⁾		129,0 ⁽¹⁰⁾	89,4	131,0 ⁽⁸⁾	110,0	129,0 ⁽⁷⁾	
	BW							153,0 ⁽⁸⁾		161,0 ⁽⁹⁾		160,0 ⁽⁶⁾		160,0 ⁽⁴⁾	89,5	160,0 ⁽³⁾	110,0	159,0 ⁽³⁾	
72	B							96,2 ⁽⁸⁾		101,0 ⁽⁸⁾		115,0 ⁽¹⁰⁾		118,0 ⁽¹¹⁾		119,0 ⁽⁹⁾	91,1	120,0 ⁽⁸⁾	
	BV							135,0 ⁽⁸⁾		144,0 ⁽⁸⁾		148,0 ⁽⁸⁾		147,0 ⁽⁵⁾		147,0 ⁽⁴⁾	91,0	147,0 ⁽³⁾	
	BW									87,9 ⁽⁵⁾		99,9 ⁽⁹⁾		105,0 ⁽¹¹⁾		110,0 ⁽¹⁰⁾		110,0 ⁽⁹⁾	
76	B									129,0 ⁽⁸⁾		136,0 ⁽⁸⁾		136,0 ⁽⁶⁾		135,0 ⁽⁵⁾		134,0 ⁽⁴⁾	
	BV											86,7 ⁽⁹⁾		92,8 ⁽⁸⁾		100,0 ⁽¹¹⁾		102,0 ⁽⁹⁾	
	BW											123,0 ⁽⁸⁾		127,0 ⁽⁸⁾		126,0 ⁽⁵⁾		125,0 ⁽⁴⁾	
80	B											62,4 ⁽⁷⁾		70,6 ⁽⁸⁾		75,8 ⁽⁹⁾		84,2 ⁽¹⁰⁾	
	BV											96,4 ⁽⁷⁾		107,0 ⁽⁹⁾		111,0 ⁽⁹⁾		109,0 ⁽⁶⁾	
	BW															59,3 ⁽⁹⁾		63,9 ⁽⁹⁾	
96	B															87,5 ⁽⁹⁾		94,5 ⁽⁹⁾	
	BV															43,4 ⁽⁷⁾		48,4 ⁽⁷⁾	
	BW															67,0 ⁽⁷⁾		73,3 ⁽⁷⁾	

1) 12° 2) 17° 3) 22° 4) 27° 5) 32° 6) 37° 7) 42° 8) 47° 9) 52° 10) 57° 11) 62°

SDWB/SDWBV/SDWBW

S 60

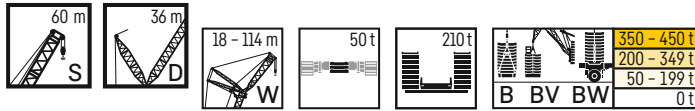

m		S 60 m															
		W 72 m		W 78 m		W 84 m		W 90 m		W 96 m		W 102 m		W 108 m		W 114 m	
		87*/85	WVmax	87*/85	WVmax	87*/85	WVmax	87*/85	WVmax	87*/85	WVmax	87*/85	WVmax	87*/85	WVmax	87*/85	WVmax
26	B	193,0*	193,0*														
	BV																
	BW	194,0*	194,0*														
28	B	191,0*	192,0 ⁽¹⁾	171,0*	171,0*												
	BV																
	BW	192,0*	193,0 ⁽¹⁾	172,0*	172,0*												
30	B	192,0	192,0	168,0*	170,0 ⁽¹⁾	151,0*	151,0*	135,0*	135,0*								
	BV																
	BW	194,0	194,0	169,0*	171,0 ⁽¹⁾	152,0*	152,0*	136,0*	136,0*								
32	B	190,0	190,0	170,0	170,0	149,0*	150,0 ⁽¹⁾	134,0*	134,0*	119,0*	119,0*						
	BV																
	BW	192,0	192,0	171,0	171,0	150,0*	151,0 ⁽¹⁾	134,0*	134,0*	120,0*	120,0*						
34	B	188,0	189,0 ⁽¹⁾	168,0	168,0	150,0	150,0	132,0*	133,0 ⁽¹⁾	118,0*	118,0*	104,0*	104,0*	92,2*	92,2*		
	BV																
	BW	190,0	191,0 ⁽¹⁾	170,0	170,0	151,0	151,0	133,0*	134,0 ⁽¹⁾	118,0*	119,0 ⁽¹⁾	105,0*	105,0*	92,3*	92,3*		
36	B	185,0	187,0 ⁽¹⁾	166,0	167,0 ⁽¹⁾	148,0	148,0	133,0	133,0	116,0*	118,0 ⁽¹⁾	103,0*	104,0 ⁽¹⁾	91,3*	91,3*	81,6*	81,6*
	BV																
	BW	188,0	190,0 ⁽¹⁾	168,0	169,0 ⁽¹⁾	150,0	150,0	134,0	134,0	117,0*	118,0 ⁽¹⁾	104,0*	104,0*	91,2*	91,2*	81,8*	81,8*
38	B	183,0	186,0 ⁽¹⁾	164,0	165,0 ⁽¹⁾	147,0	147,0	132,0	132,0	117,0	117,0	102,0*	103,0 ⁽¹⁾	90,4*	90,4 ⁽¹⁾	80,8*	80,8*
	BV																
	BW	185,0	189,0 ⁽¹⁾	166,0	168,0 ⁽¹⁾	148,0	149,0 ⁽¹⁾	133,0	133,0	118,0	118,0	102,0*	103,0 ⁽¹⁾	90,5*	90,7 ⁽¹⁾	81,0*	81,0*
40	B	180,0	184,0 ⁽¹⁾	162,0	164,0 ⁽¹⁾	145,0	145,0	131,0	131,0	116,0	116,0	102,0	102,0	90,9	90,9	80,0*	80,4 ⁽¹⁾
	BV																
	BW	183,0	188,0 ⁽¹⁾	164,0	167,0 ⁽¹⁾	147,0	148,0 ⁽¹⁾	132,0	132,0	117,0	117,0	103,0	103,0	90,5	90,5	80,2*	80,7 ⁽¹⁾
44	B	175,0	180,0 ⁽²⁾	158,0	161,0 ⁽¹⁾	142,0	143,0 ⁽²⁾	128,0	128,0	114,0	114,0	101,0	101,0	88,9	88,9	79,4	79,4
	BV																
	BW	178,0	185,0 ⁽²⁾	160,0	165,0 ⁽¹⁾	144,0	146,0 ⁽¹⁾	129,0	129,0	115,0	115,0	101,0	101,0	88,6	88,6	79,7	79,7
48	B	167,0	178,0 ⁽²⁾	153,0	159,0 ⁽²⁾	138,0	142,0 ⁽²⁾	125,0	127,0 ⁽²⁾	111,0	112,0 ⁽²⁾	98,8	98,8	86,9	86,9	78,0	78,0
	BV																
	BW	172,0	183,0 ⁽²⁾	155,0	162,0 ⁽²⁾	140,0	144,0 ⁽²⁾	127,0	128,0 ⁽²⁾	113,0	113,0	99,6	99,6	86,6	86,6	78,4	78,4
52	B	159,0	168,0 ⁽³⁾	147,0	154,0 ⁽²⁾	134,0	140,0 ⁽²⁾	122,0	126,0 ⁽²⁾	109,0	111,0 ⁽²⁾	96,7	97,3 ⁽²⁾	84,8	85,1 ⁽²⁾	76,5	76,5
	BV																
	BW	163,0	181,0 ⁽²⁾	150,0	161,0 ⁽²⁾	136,0	143,0 ⁽²⁾	124,0	127,0 ⁽²⁾	110,0	112,0 ⁽²⁾	97,6	98,5 ⁽²⁾	84,5	84,9 ⁽²⁾	77,0	77,0
56	B	150,0	157,0 ⁽³⁾	140,0	153,0 ⁽³⁾	128,0	136,0 ⁽³⁾	118,0	124,0 ⁽²⁾	105,0	109,0 ⁽²⁾	93,3	96,1 ⁽²⁾	82,6	83,9 ⁽²⁾	74,8	75,3 ⁽²⁾
	BV																
	BW	151,0	179,0 ⁽²⁾	143,0	159,0 ⁽³⁾	130,0	141,0 ⁽²⁾	119,0	126,0 ⁽²⁾	106,0	111,0 ⁽²⁾	94,3	97,4 ⁽²⁾	82,5	83,9 ⁽²⁾	75,3	75,9 ⁽²⁾
60	B	137,0	148,0 ⁽⁴⁾	133,0	142,0 ⁽⁴⁾	122,0	134,0 ⁽³⁾	113,0	122,0 ⁽³⁾	101,0	108,0 ⁽²⁾	89,2	94,8 ⁽²⁾	80,5	82,8 ⁽²⁾	72,3	74,1 ⁽²⁾
	BV																
	BW	137,0	173,0 ⁽²⁾	134,0	156,0 ⁽²⁾	124,0	139,0 ⁽³⁾	114,0	124,0 ⁽²⁾	102,0	110,0 ⁽²⁾	90,2	96,3 ⁽²⁾	80,4	82,8 ⁽²⁾	72,9	74,9 ⁽²⁾
64	B	126,0	138,0 ⁽⁵⁾	123,0	134,0 ⁽⁴⁾	116,0	126,0 ⁽⁴⁾	108,0	119,0 ⁽³⁾	96,7	105,0 ⁽³⁾	85,6	92,8 ⁽²⁾	78,5	81,4 ⁽²⁾	69,0	73,0 ⁽²⁾
	BV																
	BW	126,0	163,0 ⁽³⁾	123,0	151,0 ⁽³⁾	118,0	136,0 ⁽³⁾	110,0	123,0 ⁽³⁾	98,0	108,0 ⁽²⁾	86,6	94,5 ⁽²⁾	78,2	81,8 ⁽²⁾	69,6	73,9 ⁽²⁾
68	B	114,0	126,0 ⁽⁶⁾	114,0	124,0 ⁽⁵⁾	109,0	120,0 ⁽⁴⁾	103,0	115,0 ⁽⁴⁾	92,2	103,0 ⁽²⁾	82,1	90,5 ⁽²⁾	76,0	80,2 ⁽²⁾	66,2	71,7 ⁽²⁾
	BV																
	BW	113,0	153,0 ⁽³⁾	114,0	146,0 ⁽³⁾	110,0	133,0 ⁽³⁾	105,0	120,0 ⁽³⁾	93,5	106,0 ⁽³⁾	83,2	92,4 ⁽²⁾	75,8	80,4 ⁽²⁾	66,8	72,7 ⁽²⁾
72	B	101,0	116,0 ⁽⁶⁾	104,0	115,0 ⁽⁶⁾	102,0	113,0 ⁽⁵⁾	98,4	109,0 ⁽⁴⁾	88,1	99,4 ⁽⁴⁾	78,8	88,1 ⁽²⁾	72,9	78,8 ⁽³⁾	63,6	70,0 ⁽²⁾
	BV																
	BW	101,0	143,0 ⁽³⁾	104,0	138,0 ⁽³⁾	102,0	130,0 ⁽³⁾	99,4	118,0 ⁽³⁾	89,4	104,0 ⁽³⁾	79,9	90,3 ⁽²⁾	72,7	79,0 ⁽²⁾	64,3	70,9 ⁽²⁾
76	B	86,2	108,0 ⁽⁷⁾	92,7	107,0 ⁽⁶⁾	93,6	105,0 ⁽⁵⁾	91,9	103,0 ⁽⁵⁾	84,5	93,9 ⁽⁴⁾	75,6	84,5 ⁽²⁾	69,5	77,3 ⁽²⁾	61,1	68,2 ⁽²⁾
	BV																
	BW	86,2	133,0 ⁽³⁾	92,8	129,0 ⁽³⁾	94,0	123,0 ⁽³⁾	91,9	115,0 ⁽³⁾	85,8	102,0 ⁽³⁾	76,7	88,5 ⁽³⁾	69,2	77,7 ⁽³⁾	61,9	69,2 ⁽²⁾
80	B	65,9	101,0 ⁽⁸⁾	81,3	98,5 ⁽⁶⁾	85,2	96,2 ⁽⁵⁾	85,1	94,0 ⁽⁵⁾	80,6	91,5 ⁽⁵⁾	71,9	81,1 ⁽⁴⁾	66,7	75,7 ⁽³⁾	58,7	66,5 ⁽²⁾
	BV																
	BW	65,9	123,0 ⁽³⁾	81,3	121,0 ⁽³⁾	85,1	117,0 ⁽³⁾	84,7	110,0 ⁽³⁾	81,3	99,7 ⁽³⁾	73,7	87,0 ⁽³⁾	66,5	76,7 ⁽³⁾	59,4	67,4 ⁽²⁾
88	B		85,6 ⁽⁹⁾		83,4 ⁽⁹⁾	64,0	82,4 ⁽⁸⁾	69,8	80,4 ⁽⁶⁾	71,6	79,0 ⁽⁶⁾	65,7	74,4 ⁽⁵⁾	61,5	70,4 ⁽⁵⁾	54,2	63,6 ⁽³⁾
	BV																
	BW		107,0 ⁽⁵⁾		105,0 ⁽⁴⁾	64,3	104,0 ⁽³⁾	71,1	101,0 ⁽⁴⁾	71,4	92,4 ⁽³⁾	66,7	82,8 ⁽⁵⁾	61,5	74,0 ⁽³⁾	54,9	64,6 ⁽³⁾
96	B		69,8 ⁽¹¹⁾		72,4 ⁽¹⁰⁾		73,1 ⁽⁹⁾	51,1	71,0 ⁽⁸⁾	56,8	69,0 ⁽⁷⁾	58,0	67,2 ⁽⁶⁾	56,9	64,2 ⁽⁵⁾	50,0	60,4 ⁽⁴⁾
	BV																
	BW		95,4 ⁽⁷⁾		93,2 ⁽⁵⁾		90,4 ⁽⁴⁾	51,0	89,8 ⁽³⁾	56,8	85,2 ⁽³⁾	58,2	78,4 ⁽⁵⁾	56,7	70,2 ⁽⁴⁾	50,8	62,0 ⁽³⁾
104	B		53,8 ⁽⁹⁾		59,3 ⁽¹⁰⁾		62,3 ⁽¹⁰⁾		62,3 ⁽⁹⁾	36,1	62,0 ⁽⁸⁾	43,9	59,6 ⁽⁷⁾	48,9	58,4 ⁽⁶⁾	44,4	55,6 ⁽⁵⁾
	BV																
	BW		79,1 ⁽⁸⁾		81,0 ⁽⁸⁾		78,4 ⁽⁴⁾		77,8 ⁽⁴⁾	36,1	76,1 ⁽³⁾	44,0	73,9 ⁽³⁾	46,1	66,4 ⁽³⁾	45,9	59,4 ⁽³⁾
112	B		39,1 ⁽⁷⁾		45,2 ⁽⁹⁾		49,9 ⁽⁹⁾		52,2 ⁽¹⁰⁾		53,3 ⁽⁹⁾		52,0 ⁽⁸⁾	35,1	51,6 ⁽⁷⁾	37,5	49,8 ⁽⁶⁾
	BV																
	BW		62,3 ⁽⁷⁾		67,7 ⁽⁹⁾		67,7 ⁽⁷⁾		67,1 ⁽⁶⁾		66,3 ⁽⁴⁾		64,7 ⁽³⁾	34,0	61,1 ⁽³⁾	37,6	56,7 ⁽³⁾
120	B				32,3 ⁽⁷⁾		37,8 ⁽⁹⁾		40,9 ⁽⁹⁾		44,0 ⁽¹⁰⁾		43,8 ⁽⁹⁾		43,5 ⁽⁸⁾	25,5	41,2 ⁽⁸⁾
	BV																
	BW				52,2 ⁽⁷⁾		58,6 ⁽⁹⁾		58,2 ⁽⁸⁾		57,2 ⁽⁵⁾		55,5 ⁽⁴⁾		53,3 ⁽³⁾	25,6	51,9 ⁽⁴⁾
128	B						26,3 ⁽⁷⁾		29,1 ⁽⁷⁾		34,0 ⁽⁹⁾		35,8 ⁽¹⁰⁾		36,3 ⁽⁹⁾		35,3 ⁽⁹⁾
	BV																
	BW						44,7 ⁽⁷⁾		49,4 ⁽⁷⁾		50,1 ⁽⁶⁾		48,2 ⁽⁵⁾		46,7 ⁽⁴⁾		45,8 ⁽⁴⁾
136	B												23,2 ⁽⁷⁾		26,3 ⁽⁹⁾		28,8 ⁽¹⁰⁾
	BV																
	BW												41,7 ⁽⁷⁾		42,3 ⁽⁷⁾		39,6 ⁽⁴⁾
144	B												16,7 ⁽⁷⁾		20,3 ⁽⁹⁾		21,4 ⁽⁹⁾
	BV																
	BW												34,3 ⁽⁷⁾		36,1 ⁽⁸⁾		34,2 ⁽⁵⁾
152	B														11,1 ⁽⁷⁾		7,7 ⁽⁴⁾
	BV																
	BW														27,7 ⁽⁷⁾		29,0 ⁽⁷⁾

1) 12° 2) 17° 3) 22° 4) 27° 5) 32° 6) 37° 7) 42° 8) 47° 9) 52° 10) 57° 11) 62°

SDWB/SDWBV/SDWBW

S 66

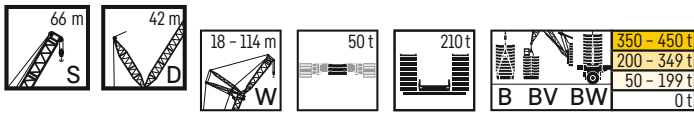

m	S 66 m																		
	W 18 m		W 24 m		W 30 m		W 36 m		W 42 m		W 48 m		W 54 m		W 60 m		W 66 m		
	87°/85	WVmax	87°/85	WVmax	87°/85	WVmax	87°/85	WVmax	87°/85	WVmax	87°/85	WVmax	87°/85	WVmax	87°/85	WVmax	87°/85	WVmax	
14	B	505,0*	516,0 ⁽¹⁾																
	BV																		
	BW	512,0*	527,0 ⁽¹⁾																
16	B	516,0	516,0	441,0*	455,0 ⁽¹⁾	407,0*	407,0*												
	BV	529,0	529,0																
	BW	530,0	531,0 ⁽¹⁾	448,0*	465,0 ⁽¹⁾	412,0*	412,0*												
18	B	494,0	501,0 ⁽¹⁾	453,0	453,0	393,0*	409,0 ⁽¹⁾	359,0*	359,0*										
	BV	506,0	527,0 ⁽¹⁾	464,0	464,0														
	BW	507,0	532,0 ⁽¹⁾	464,0	464,0	398,0*	417,0 ⁽¹⁾	364,0*	364,0*										
20	B	469,0	489,0 ⁽¹⁾	433,0	435,0 ⁽²⁾	405,0	406,0 ⁽¹⁾	348,0*	365,0 ⁽¹⁾	318,0*	318,0*	287,0*	287,0*						
	BV	481,0	524,0 ⁽¹⁾	444,0	453,0 ⁽¹⁾	415,0	415,0												
	BW	481,0	532,0 ⁽¹⁾	445,0	450,0 ⁽²⁾	415,0	420,0 ⁽¹⁾	354,0*	371,0 ⁽¹⁾	322,0*	322,0*	289,0*	289,0*						
22	B	429,0	476,0 ⁽¹⁾	413,0	424,0 ⁽²⁾	391,0	400,0 ⁽¹⁾	361,0	361,0	310,0*	323,0 ⁽¹⁾	282,0*	286,0 ⁽¹⁾	255,0*	255,0*				
	BV	427,0	521,0 ⁽¹⁾	424,0	450,0 ⁽²⁾	403,0	423,0 ⁽¹⁾	369,0	369,0	330,0	330,0								
	BW	427,0	533,0 ⁽¹⁾	424,0	451,0 ⁽²⁾	403,0	423,0 ⁽¹⁾	370,0	373,0 ⁽¹⁾	314,0*	328,0 ⁽¹⁾	285,0*	289,0 ⁽¹⁾	256,0*	256,0*				
24	B	366,0	454,0 ⁽¹⁾	394,0	414,0 ⁽²⁾	376,0	395,0 ⁽¹⁾	349,0	357,0 ⁽¹⁾	321,0	321,0	289,0	289,0	251,0*	254,0 ⁽¹⁾	226,0*	226,0*		
	BV	367,0	509,0 ⁽¹⁾	400,0	451,0 ⁽²⁾	390,0	425,0 ⁽¹⁾	360,0	373,0 ⁽¹⁾	326,0	329,0 ⁽¹⁾	293,0	293,0						
	BW	366,0	524,0 ⁽¹⁾	399,0	452,0 ⁽²⁾	390,0	425,0 ⁽¹⁾	360,0	373,0 ⁽¹⁾	326,0	329,0 ⁽¹⁾	293,0	293,0	253,0*	257,0 ⁽¹⁾	228,0*	228,0*		
26	B	285,0	422,0 ⁽²⁾	355,0	404,0 ⁽²⁾	362,0	390,0 ⁽¹⁾	336,0	353,0 ⁽¹⁾	311,0	318,0 ⁽¹⁾	283,0	285,0 ⁽¹⁾	255,0	255,0	222,0*	226,0 ⁽¹⁾	200,0*	200,0*
	BV	286,0	489,0 ⁽¹⁾	357,0	452,0 ⁽²⁾	377,0	428,0 ⁽¹⁾	349,0	374,0 ⁽¹⁾	321,0	328,0 ⁽¹⁾	289,0	291,0 ⁽¹⁾	259,0	259,0				
	BW	285,0	504,0 ⁽¹⁾	356,0	453,0 ⁽²⁾	376,0	428,0 ⁽¹⁾	349,0	373,0 ⁽¹⁾	321,0	328,0 ⁽¹⁾	290,0	291,0 ⁽¹⁾	259,0	259,0	225,0*	228,0 ⁽¹⁾	202,0*	202,0*
28	B		393,0 ⁽³⁾	317,0	387,0 ⁽²⁾	345,0	381,0 ⁽¹⁾	323,0	349,0 ⁽¹⁾	300,0	316,0 ⁽¹⁾	276,0	283,0 ⁽¹⁾	251,0	251,0	225,0	225,0	197,0*	200,0 ⁽¹⁾
	BV		468,0 ⁽¹⁾	318,0	445,0 ⁽²⁾	362,0	426,0 ⁽¹⁾	337,0	374,0 ⁽¹⁾	312,0	328,0 ⁽¹⁾	284,0	290,0 ⁽¹⁾	255,0	258,0 ⁽¹⁾	229,0	229,0		
	BW		484,0 ⁽¹⁾	317,0	447,0 ⁽²⁾	363,0	426,0 ⁽¹⁾	337,0	373,0 ⁽¹⁾	313,0	328,0 ⁽¹⁾	285,0	290,0 ⁽¹⁾	256,0	256,0	229,0	229,0	199,0*	203,0 ⁽¹⁾
30	B		367,0 ⁽⁵⁾	281,0	362,0 ⁽³⁾	331,0	358,0 ⁽²⁾	310,0	344,0 ⁽¹⁾	289,0	313,0 ⁽¹⁾	268,0	281,0 ⁽¹⁾	246,0	246,0	222,0	222,0	199,0	199,0
	BV		448,0 ⁽¹⁾	282,0	430,0 ⁽²⁾	347,0	413,0 ⁽¹⁾	325,0	373,0 ⁽¹⁾	302,0	328,0 ⁽¹⁾	279,0	290,0 ⁽¹⁾	251,0	257,0 ⁽¹⁾	226,0	228,0 ⁽¹⁾	202,0	202,0
	BW		464,0 ⁽¹⁾	281,0	433,0 ⁽²⁾	346,0	415,0 ⁽¹⁾	325,0	372,0 ⁽¹⁾	302,0	327,0 ⁽¹⁾	279,0	290,0 ⁽¹⁾	252,0	252,0	226,0	226,0	203,0	203,0
32	B		343,0 ⁽⁶⁾	229,0	340,0 ⁽⁴⁾	316,0	337,0 ⁽²⁾	298,0	326,0 ⁽²⁾	279,0	311,0 ⁽¹⁾	259,0	279,0 ⁽¹⁾	239,0	241,0 ⁽²⁾	218,0	218,0	197,0	197,0
	BV		428,0 ⁽³⁾	231,0	414,0 ⁽²⁾	322,0	400,0 ⁽¹⁾	313,0	367,0 ⁽¹⁾	292,0	327,0 ⁽¹⁾	271,0	289,0 ⁽¹⁾	247,0	256,0 ⁽¹⁾	223,0	227,0 ⁽¹⁾	200,0	201,0 ⁽¹⁾
	BW		441,0 ⁽¹⁾	231,0	419,0 ⁽²⁾	322,0	404,0 ⁽¹⁾	313,0	368,0 ⁽¹⁾	292,0	327,0 ⁽¹⁾	271,0	289,0 ⁽¹⁾	248,0	250,0 ⁽²⁾	223,0	223,0	200,0	200,0
34	B		319,0 ⁽⁷⁾		320,0 ⁽⁵⁾	301,0	317,0 ⁽³⁾	285,0	312,0 ⁽²⁾	267,0	297,0 ⁽¹⁾	250,0	278,0 ⁽¹⁾	232,0	239,0 ⁽²⁾	214,0	214,0	194,0	194,0
	BV		409,0 ⁽³⁾		399,0 ⁽²⁾	306,0	387,0 ⁽¹⁾	301,0	360,0 ⁽¹⁾	282,0	324,0 ⁽¹⁾	263,0	288,0 ⁽¹⁾	242,0	255,0 ⁽¹⁾	220,0	226,0 ⁽¹⁾	197,0	200,0 ⁽¹⁾
	BW		417,0 ⁽¹⁾		405,0 ⁽²⁾	306,0	394,0 ⁽¹⁾	300,0	363,0 ⁽¹⁾	282,0	321,0 ⁽²⁾	263,0	288,0 ⁽¹⁾	242,0	250,0 ⁽²⁾	220,0	221,0 ⁽²⁾	198,0	198,0
36	B		298,0 ⁽²⁾		300,0 ⁽⁵⁾	259,0	299,0 ⁽⁵⁾	274,0	295,0 ⁽³⁾	257,0	285,0 ⁽²⁾	242,0	270,0 ⁽¹⁾	225,0	238,0 ⁽²⁾	208,0	214,0 ⁽²⁾	190,0	191,0 ⁽²⁾
	BV		389,0 ⁽⁴⁾		382,0 ⁽²⁾	262,0	373,0 ⁽¹⁾	288,0	354,0 ⁽¹⁾	272,0	320,0 ⁽¹⁾	254,0	283,0 ⁽²⁾	235,0	254,0 ⁽¹⁾	216,0	225,0 ⁽¹⁾	195,0	200,0 ⁽¹⁾
	BW		394,0 ⁽¹⁾		387,0 ⁽²⁾	262,0	381,0 ⁽¹⁾	287,0	358,0 ⁽¹⁾	272,0	318,0 ⁽²⁾	254,0	283,0 ⁽²⁾	235,0	249,0 ⁽²⁾	216,0	221,0 ⁽²⁾	195,0	196,0 ⁽²⁾
38	B		281,0 ⁽⁴⁾		280,0 ⁽⁶⁾	210,0	283,0 ⁽⁶⁾	264,0	280,0 ⁽⁴⁾	248,0	272,0 ⁽³⁾	244,0	262,0 ⁽¹⁾	218,0	237,0 ⁽²⁾	202,0	213,0 ⁽²⁾	187,0	190,0 ⁽²⁾
	BV		369,0 ⁽¹⁾		365,0 ⁽³⁾	213,0	359,0 ⁽²⁾	276,0	347,0 ⁽¹⁾	261,0	316,0 ⁽¹⁾	256,0	283,0 ⁽²⁾	228,0	250,0 ⁽²⁾	211,0	221,0 ⁽²⁾	192,0	199,0 ⁽¹⁾
	BW		372,0 ⁽³⁾		368,0 ⁽²⁾	212,0	364,0 ⁽¹⁾	276,0	354,0 ⁽¹⁾	261,0	314,0 ⁽²⁾	246,0	283,0 ⁽²⁾	229,0	249,0 ⁽²⁾	211,0	221,0 ⁽²⁾	193,0	196,0 ⁽²⁾
40	B		265,0 ⁽⁸⁾		263,0 ⁽³⁾		268,0 ⁽⁷⁾	249,0	265,0 ⁽⁵⁾	238,0	260,0 ⁽³⁾	225,0	253,0 ⁽¹⁾	211,0	236,0 ⁽²⁾	196,0	213,0 ⁽²⁾	182,0	190,0 ⁽²⁾
	BV		349,0 ⁽⁴⁾		348,0 ⁽³⁾		344,0 ⁽³⁾	256,0	334,0 ⁽¹⁾	250,0	312,0 ⁽¹⁾	238,0	281,0 ⁽²⁾	222,0	250,0 ⁽²⁾	205,0	221,0 ⁽²⁾	189,0	198,0 ⁽¹⁾
	BW		351,0 ⁽³⁾		350,0 ⁽²⁾		346,0 ⁽¹⁾	256,0	340,0 ⁽¹⁾	250,0	309,0 ⁽²⁾	238,0	281,0 ⁽²⁾	222,0	249,0 ⁽²⁾	205,0	221,0 ⁽²⁾	189,0	196,0 ⁽²⁾
44	B		236,0 ⁽⁹⁾		237,0 ⁽⁹⁾		242,0 ⁽⁹⁾	182,0	241,0 ⁽⁷⁾	222,0	237,0 ⁽⁵⁾	210,0	236,0 ⁽¹⁾	198,0	221,0 ⁽²⁾	185,0	210,0 ⁽²⁾	172,0	189,0 ⁽²⁾
	BV		310,0 ⁽⁴⁾		313,0 ⁽⁵⁾		314,0 ⁽⁵⁾	184,0	309,0 ⁽⁵⁾	231,0	298,0 ⁽²⁾	222,0	278,0 ⁽²⁾	209,0	247,0 ⁽²⁾	194,0	220,0 ⁽²⁾	180,0	195,0 ⁽²⁾
	BW		310,0 ⁽⁴⁾		314,0 ⁽⁵⁾		313,0 ⁽⁵⁾	184,0	310,0 ⁽¹⁾	230,0	302,0 ⁽²⁾	222,0	277,0 ⁽²⁾	209,0	246,0 ⁽²⁾	194,0	220,0 ⁽²⁾	180,0	195,0 ⁽²⁾
48	B		206,0 ⁽⁹⁾		214,0 ⁽¹⁰⁾		214,0 ⁽¹⁰⁾	189,0	219,0 ⁽⁹⁾	189,0	216,0 ⁽⁶⁾	195,0	219,0 ⁽¹⁾	185,0	205,0 ⁽⁴⁾	174,0	198,0 ⁽³⁾	163,0	183,0 ⁽²⁾
	BV		276,0 ⁽⁵⁾		288,0 ⁽¹⁾		285,0 ⁽⁷⁾	283,0 ⁽³⁾	283,0 ⁽³⁾	191,0	279,0 ⁽³⁾	202,0	271,0 ⁽²⁾	196,0	245,0 ⁽²⁾	183,0	218,0 ⁽²⁾	171,0	194,0 ⁽²⁾
	BW		273,0 ⁽⁹⁾		279,0 ⁽³⁾		285,0 ⁽⁷⁾	283,0 ⁽³⁾	283,0 ⁽³⁾	191,0	279,0 ⁽³⁾	201,0	271,0 ⁽²⁾	196,0	244,0 ⁽²⁾	184,0	217,0 ⁽²⁾	171,0	194,0 ⁽²⁾
52	B				190,0 ⁽¹⁰⁾		193,0 ⁽¹⁰⁾		197,0 ⁽¹⁰⁾		198,0 ⁽⁸⁾	173,0	202,0 ⁽¹⁾	174,0	192,0 ⁽⁵⁾	164,0	186,0 ⁽⁴⁾	154,0	176,0 ⁽³⁾
	BV				264,0 ⁽¹⁾		260,0 ⁽⁷⁾		259,0 ⁽⁶⁾		257,0 ⁽⁴⁾	174,0	254,0 ⁽³⁾	178,0	237,0 ⁽²⁾	173,0	215,0 ⁽²⁾	162,0	191,0 ⁽²⁾
	BW				250,0 ⁽⁶⁾		260,0 ⁽⁷⁾		259,0 ⁽⁶⁾		257,0 ⁽³⁾	173,0	254,0 ⁽³⁾	177,0	236,0 ⁽²⁾	173,0	215,0 ⁽²⁾	162,0	191,0 ⁽²⁾
56	B						174,0 ⁽¹⁰⁾		177,0 ⁽¹⁰⁾		182,0 ⁽¹⁰⁾	135,0	185,0 ⁽¹⁾	158,0	178,0 ⁽⁶⁾	153,0	172,0 ⁽⁵⁾	146,0	165,0 ⁽⁴⁾
	BV						235,0 ⁽⁷⁾		238,0 ⁽⁶⁾		236,0 ⁽⁴⁾	136,0	235,0 ⁽³⁾						

SDWB/SDWBV/SDWBW

S 72

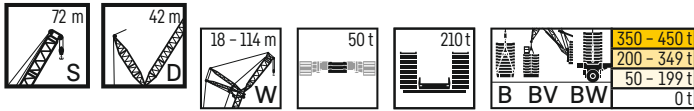

m	S 72 m																	
	W 18 m		W 24 m		W 30 m		W 36 m		W 42 m		W 48 m		W 54 m		W 60 m		W 66 m	
	87°/85	WVmax	87°/85	WVmax	87°/85	WVmax	87°/85	WVmax	87°/85	WVmax	87°/85	WVmax	87°/85	WVmax	87°/85	WVmax	87°/85	WVmax
14	B 452,0*	452,0*																
16	B 431,0*	461,0 ⁽¹⁾	396,0*	405,0 ⁽¹⁾	365,0*	365,0*												
18	B 445,0	453,0 ⁽¹⁾	406,0	406,0	353,0*	365,0 ⁽¹⁾	322,0*	322,0*										
20	B 424,0	449,0 ⁽¹⁾	390,0	390,0	365,0	365,0	313,0*	325,0 ⁽¹⁾	285,0*	285,0*								
22	B 412,0	444,0 ⁽¹⁾	373,0	385,0 ⁽²⁾	353,0	359,0 ⁽¹⁾	325,0	325,0	278,0*	291,0 ⁽¹⁾	255,0*	259,0 ⁽¹⁾	231,0*	231,0*				
24	B 380,0	440,0 ⁽¹⁾	356,0	382,0 ⁽²⁾	340,0	357,0 ⁽¹⁾	315,0	320,0 ⁽¹⁾	289,0	289,0	248,0*	259,0 ⁽¹⁾	225,0*	232,0 ⁽¹⁾	206,0*	206,0*		
26	B 309,0	412,0 ⁽¹⁾	339,0	379,0 ⁽²⁾	327,0	355,0 ⁽¹⁾	303,0	319,0 ⁽¹⁾	280,0	286,0 ⁽¹⁾	257,0	257,0	232,0	232,0	202,0*	206,0 ⁽¹⁾	182,0*	182,0*
28	B 442,0 ⁽¹⁾	322,0	375,0 ⁽²⁾	313,0	353,0 ⁽¹⁾	292,0	317,0 ⁽¹⁾	271,0	284,0 ⁽¹⁾	250,0	255,0 ⁽¹⁾	227,0	228,0 ⁽¹⁾	206,0	206,0	178,0*	182,0 ⁽¹⁾	
30	B 360,0 ⁽⁵⁾	292,0	354,0 ⁽²⁾	301,0	339,0 ⁽¹⁾	281,0	316,0 ⁽¹⁾	260,0	284,0 ⁽¹⁾	242,0	254,0 ⁽¹⁾	222,0	225,0 ⁽¹⁾	203,0	203,0	182,0	182,0	
32	B 338,0 ⁽⁷⁾	247,0	334,0 ⁽⁴⁾	288,0	324,0 ⁽²⁾	269,0	307,0 ⁽¹⁾	251,0	283,0 ⁽¹⁾	235,0	253,0 ⁽¹⁾	216,0	223,0 ⁽¹⁾	199,0	199,0	180,0	180,0	
34	B 317,0 ⁽⁷⁾	277,0	308,0 ⁽⁵⁾	260,0	294,0 ⁽²⁾	243,0	277,0 ⁽¹⁾	226,0	252,0 ⁽¹⁾	209,0	220,0 ⁽¹⁾	194,0	194,0	177,0	177,0			
36	B 296,0 ⁽⁸⁾	297,0 ⁽⁶⁾	266,0	293,0 ⁽⁴⁾	250,0	282,0 ⁽³⁾	234,0	266,0 ⁽¹⁾	219,0	249,0 ⁽¹⁾	204,0	218,0 ⁽¹⁾	189,0	193,0 ⁽²⁾	173,0	173,0		
38	B 275,0 ⁽⁹⁾	279,0 ⁽⁶⁾	226,0	278,0 ⁽⁵⁾	238,0	269,0 ⁽³⁾	225,0	256,0 ⁽¹⁾	212,0	241,0 ⁽¹⁾	196,0	215,0 ⁽¹⁾	184,0	193,0 ⁽²⁾	169,0	171,0 ⁽²⁾		
40	B 347,0 ⁽⁵⁾	263,0 ⁽⁷⁾	211,0 ⁽¹⁾	214,0 ⁽¹⁰⁾	195,0	236,0 ⁽⁶⁾	203,0	228,0 ⁽⁴⁾	191,0	219,0 ⁽¹⁾	179,0	206,0 ⁽²⁾	168,0	193,0 ⁽²⁾	156,0	171,0 ⁽²⁾		
42	B 311,0 ⁽⁵⁾	311,0 ⁽⁵⁾	234,0 ⁽¹⁾	239,0 ⁽¹⁰⁾	195,0	236,0 ⁽⁶⁾	203,0	228,0 ⁽⁴⁾	191,0	219,0 ⁽¹⁾	179,0	206,0 ⁽²⁾	168,0	193,0 ⁽²⁾	156,0	171,0 ⁽²⁾		
44	B 311,0 ⁽⁵⁾	311,0 ⁽⁵⁾	234,0 ⁽¹⁾	239,0 ⁽¹⁰⁾	195,0	236,0 ⁽⁶⁾	203,0	228,0 ⁽⁴⁾	191,0	219,0 ⁽¹⁾	179,0	206,0 ⁽²⁾	168,0	193,0 ⁽²⁾	156,0	171,0 ⁽²⁾		
46	B 276,0 ⁽⁶⁾	288,0 ⁽⁴⁾	211,0 ⁽¹⁾	214,0 ⁽¹⁰⁾	195,0	236,0 ⁽⁶⁾	203,0	228,0 ⁽⁴⁾	191,0	219,0 ⁽¹⁾	179,0	206,0 ⁽²⁾	168,0	193,0 ⁽²⁾	156,0	171,0 ⁽²⁾		
48	B 248,0 ⁽⁷⁾	266,0 ⁽¹⁾	189,0 ⁽¹⁰⁾	191,0 ⁽¹⁰⁾	196,0 ⁽¹⁰⁾	257,0 ⁽⁸⁾	255,0 ⁽⁵⁾	251,0 ⁽⁴⁾	168,0	191,0 ⁽⁶⁾	157,0	182,0 ⁽⁴⁾	150,0	173,0 ⁽³⁾	139,0	164,0 ⁽³⁾		
50	B 226,0 ⁽⁷⁾	250,0 ⁽⁴⁾	167,0 ⁽¹⁰⁾	172,0 ⁽¹⁰⁾	176,0 ⁽¹¹⁾	257,0 ⁽⁸⁾	255,0 ⁽⁵⁾	250,0 ⁽⁴⁾	174,0	235,0 ⁽³⁾	162,0	216,0 ⁽²⁾	154,0	196,0 ⁽²⁾	144,0	175,0 ⁽²⁾		
52	B 204,0 ⁽⁷⁾	243,0 ⁽¹⁾	154,0 ⁽¹⁰⁾	154,0 ⁽¹⁰⁾	159,0 ⁽¹⁰⁾	234,0 ⁽⁸⁾	235,0 ⁽⁸⁾	233,0 ⁽⁵⁾	143,0	224,0 ⁽⁴⁾	154,0	208,0 ⁽³⁾	146,0	192,0 ⁽²⁾	136,0	173,0 ⁽²⁾		
54	B 184,0 ⁽⁵⁾	226,0 ⁽⁶⁾	149,0 ⁽⁸⁾	154,0 ⁽¹⁰⁾	159,0 ⁽¹⁰⁾	234,0 ⁽⁸⁾	235,0 ⁽⁸⁾	233,0 ⁽⁵⁾	143,0	223,0 ⁽⁴⁾	154,0	207,0 ⁽³⁾	147,0	192,0 ⁽²⁾	136,0	173,0 ⁽²⁾		
56	B 167,0 ⁽⁵⁾	209,0 ⁽⁸⁾	133,0 ⁽⁸⁾	143,0 ⁽¹⁰⁾	143,0 ⁽¹⁰⁾	212,0 ⁽⁸⁾	216,0 ⁽⁸⁾	215,0 ⁽⁶⁾	162,0 ⁽¹⁰⁾	164,0 ⁽⁹⁾	135,0	159,0 ⁽⁷⁾	133,0	152,0 ⁽⁵⁾	124,0	146,0 ⁽⁴⁾		
58	B 167,0 ⁽⁵⁾	175,0 ⁽⁸⁾	133,0 ⁽⁸⁾	135,0 ⁽⁸⁾	143,0 ⁽¹⁰⁾	212,0 ⁽⁸⁾	216,0 ⁽⁸⁾	215,0 ⁽⁶⁾	162,0 ⁽¹⁰⁾	164,0 ⁽⁹⁾	135,0	159,0 ⁽⁷⁾	133,0	152,0 ⁽⁵⁾	124,0	146,0 ⁽⁴⁾		
60	B 154,0 ⁽⁶⁾	175,0 ⁽⁸⁾	133,0 ⁽⁸⁾	135,0 ⁽⁸⁾	143,0 ⁽¹⁰⁾	212,0 ⁽⁸⁾	216,0 ⁽⁸⁾	215,0 ⁽⁶⁾	162,0 ⁽¹⁰⁾	164,0 ⁽⁹⁾	135,0	159,0 ⁽⁷⁾	133,0	152,0 ⁽⁵⁾	124,0	146,0 ⁽⁴⁾		
62	B 154,0 ⁽⁶⁾	175,0 ⁽⁸⁾	133,0 ⁽⁸⁾	135,0 ⁽⁸⁾	143,0 ⁽¹⁰⁾	212,0 ⁽⁸⁾	216,0 ⁽⁸⁾	215,0 ⁽⁶⁾	162,0 ⁽¹⁰⁾	164,0 ⁽⁹⁾	135,0	159,0 ⁽⁷⁾	133,0	152,0 ⁽⁵⁾	124,0	146,0 ⁽⁴⁾		
64	B 154,0 ⁽⁶⁾	175,0 ⁽⁸⁾	133,0 ⁽⁸⁾	135,0 ⁽⁸⁾	143,0 ⁽¹⁰⁾	212,0 ⁽⁸⁾	216,0 ⁽⁸⁾	215,0 ⁽⁶⁾	162,0 ⁽¹⁰⁾	164,0 ⁽⁹⁾	135,0	159,0 ⁽⁷⁾	133,0	152,0 ⁽⁵⁾	124,0	146,0 ⁽⁴⁾		
66	B 154,0 ⁽⁶⁾	175,0 ⁽⁸⁾	133,0 ⁽⁸⁾	135,0 ⁽⁸⁾	143,0 ⁽¹⁰⁾	212,0 ⁽⁸⁾	216,0 ⁽⁸⁾	215,0 ⁽⁶⁾	162,0 ⁽¹⁰⁾	164,0 ⁽⁹⁾	135,0	159,0 ⁽⁷⁾	133,0	152,0 ⁽⁵⁾	124,0	146,0 ⁽⁴⁾		
68	B 154,0 ⁽⁶⁾	175,0 ⁽⁸⁾	133,0 ⁽⁸⁾	135,0 ⁽⁸⁾	143,0 ⁽¹⁰⁾	212,0 ⁽⁸⁾	216,0 ⁽⁸⁾	215,0 ⁽⁶⁾	162,0 ⁽¹⁰⁾	164,0 ⁽⁹⁾	135,0	159,0 ⁽⁷⁾	133,0	152,0 ⁽⁵⁾	124,0	146,0 ⁽⁴⁾		
70	B 154,0 ⁽⁶⁾	175,0 ⁽⁸⁾	133,0 ⁽⁸⁾	135,0 ⁽⁸⁾	143,0 ⁽¹⁰⁾	212,0 ⁽⁸⁾	216,0 ⁽⁸⁾	215,0 ⁽⁶⁾	162,0 ⁽¹⁰⁾	164,0 ⁽⁹⁾	135,0	159,0 ⁽⁷⁾	133,0	152,0 ⁽⁵⁾	124,0	146,0 ⁽⁴⁾		
72	B 154,0 ⁽⁶⁾	175,0 ⁽⁸⁾	133,0 ⁽⁸⁾	135,0 ⁽⁸⁾	143,0 ⁽¹⁰⁾	212,0 ⁽⁸⁾	216,0 ⁽⁸⁾	215,0 ⁽⁶⁾	162,0 ⁽¹⁰⁾	164,0 ⁽⁹⁾	135,0	159,0 ⁽⁷⁾	133,0	152,0 ⁽⁵⁾	124,0	146,0 ⁽⁴⁾		
74	B 154,0 ⁽⁶⁾	175,0 ⁽⁸⁾	133,0 ⁽⁸⁾	135,0 ⁽⁸⁾	143,0 ⁽¹⁰⁾	212,0 ⁽⁸⁾	216,0 ⁽⁸⁾	215,0 ⁽⁶⁾	162,0 ⁽¹⁰⁾	164,0 ⁽⁹⁾	135,0	159,0 ⁽⁷⁾	133,0	152,0 ⁽⁵⁾	124,0	146,0 ⁽⁴⁾		
76	B 154,0 ⁽⁶⁾	175,0 ⁽⁸⁾	133,0 ⁽⁸⁾	135,0 ⁽⁸⁾	143,0 ⁽¹⁰⁾	212,0 ⁽⁸⁾	216,0 ⁽⁸⁾	215,0 ⁽⁶⁾	162,0 ⁽¹⁰⁾	164,0 ⁽⁹⁾	135,0	159,0 ⁽⁷⁾	133,0	152,0 ⁽⁵⁾	124,0	146,0 ⁽⁴⁾		
78	B 154,0 ⁽⁶⁾	175,0 ⁽⁸⁾	133,0 ⁽⁸⁾	135,0 ⁽⁸⁾	143,0 ⁽¹⁰⁾	212,0 ⁽⁸⁾	216,0 ⁽⁸⁾	215,0 ⁽⁶⁾	162,0 ⁽¹⁰⁾	164,0 ⁽⁹⁾	135,0	159,0 ⁽⁷⁾	133,0	152,0 ⁽⁵⁾	124,0	146,0 ⁽⁴⁾		
80	B 154,0 ⁽⁶⁾	175,0 ⁽⁸⁾	133,0 ⁽⁸⁾	135,0 ⁽⁸⁾	143,0 ⁽¹⁰⁾	212,0 ⁽⁸⁾	216,0 ⁽⁸⁾	215,0 ⁽⁶⁾	162,0 ⁽¹⁰⁾	164,0 ⁽⁹⁾	135,0	159,0 ⁽⁷⁾	133,0	152,0 ⁽⁵⁾	124,0	146,0 ⁽⁴⁾		
82	B 154,0 ⁽⁶⁾	175,0 ⁽⁸⁾	133,0 ⁽⁸⁾	135,0 ⁽⁸⁾	143,0 ⁽¹⁰⁾	212,0 ⁽⁸⁾	216,0 ⁽⁸⁾	215,0 ⁽⁶⁾	162,0 ⁽¹⁰⁾	164,0 ⁽⁹⁾	135,0	159,0 ⁽⁷⁾	133,0	152,0 ⁽⁵⁾	124,0	146,0 ⁽⁴⁾		
84	B 154,0 ⁽⁶⁾	175,0 ⁽⁸⁾	133,0 ⁽⁸⁾	135,0 ⁽⁸⁾	143,0 ⁽¹⁰⁾	212,0 ⁽⁸⁾	216,0 ⁽⁸⁾	215,0 ⁽⁶⁾	162,0 ⁽¹⁰⁾	164,0 ⁽⁹⁾	135,0	159,0 ⁽⁷⁾	133,0	152,0 ⁽⁵⁾	124,0	146,0 ⁽⁴⁾		
86	B 154,0 ⁽⁶⁾	175,0 ⁽⁸⁾	133,0 ⁽⁸⁾	135,0 ⁽⁸⁾	143,0 ⁽¹⁰⁾	212,0 ⁽⁸⁾	216,0 ⁽⁸⁾	215,0 ⁽⁶⁾	162,0 ⁽¹⁰⁾	164,0 ⁽⁹⁾	135,0	159,0 ⁽⁷⁾	133,0	152,0 ⁽⁵⁾	124,0	146,0 ⁽⁴⁾		
88	B 154,0 ⁽⁶⁾	175,0 ⁽⁸⁾	133,0 ⁽⁸⁾	135,0 ⁽⁸⁾	143,0 ⁽¹⁰⁾	212,0 ⁽⁸⁾	216,0 ⁽⁸⁾	215,0 ⁽⁶⁾	162,0 ⁽¹⁰⁾	164,0 ⁽⁹⁾	135,0	159,0 ⁽⁷⁾	133,0	152,0 ⁽⁵⁾	124,0	146,0 ⁽⁴⁾		
90	B 154,0 ⁽⁶⁾	175,0 ⁽⁸⁾	133,0 ⁽⁸⁾	135,0 ⁽⁸⁾	143,0 ⁽¹⁰⁾	212,0 ⁽⁸⁾	216,0 ⁽⁸⁾	215,0 ⁽⁶⁾	162,0 ⁽¹⁰⁾	164,0 ⁽⁹⁾	135,0	159,0 ⁽⁷⁾	133,0	152,0 ⁽⁵⁾	124,0	146,0 ⁽⁴⁾		
92	B 154,0 ⁽⁶⁾	175,0 ⁽⁸⁾	133,0 ⁽⁸⁾	135,0 ⁽⁸⁾	143,0 ⁽¹⁰⁾	212,0 ⁽⁸⁾	216,0 ⁽⁸⁾	215,0 ⁽⁶⁾	162,0 ⁽¹⁰⁾	164,0 ⁽⁹⁾	135,0	159,0 ⁽⁷⁾	133,0	152,0 ⁽⁵⁾	124,0	146,0 ⁽⁴⁾		
94	B 154,0 ⁽⁶⁾	175,0 ⁽⁸⁾	133,0 ⁽⁸⁾	135,0 ⁽⁸⁾	143,0 ⁽¹⁰⁾	212,0 ⁽⁸⁾	216,0 ⁽⁸⁾	215,0 ⁽⁶⁾	162,0 ⁽¹⁰⁾	164,0 ⁽⁹⁾	135,0	159,0 ⁽⁷⁾	133,0	152,0 ⁽⁵⁾	124,0	146,0 ⁽⁴⁾		
96	B 154,0 ⁽⁶⁾	175,0 ⁽⁸⁾	133,0 ⁽⁸⁾	135,0 ⁽⁸⁾	143,0 ⁽¹⁰⁾	212,0 ⁽⁸⁾	216,0 ⁽⁸⁾	215,0 ⁽⁶⁾	162,0 ⁽¹⁰⁾	164,0 ⁽⁹⁾	135,0	159,0 ⁽⁷⁾	133,0	152,0 ⁽⁵⁾	124,0	146,0 ⁽⁴⁾		
98	B 154,0 ⁽⁶⁾	175,0 ⁽⁸⁾	133,0 ⁽⁸⁾	135,0 ⁽⁸⁾	143,0 ⁽¹⁰⁾	212,0 ⁽⁸⁾	216,0 ⁽⁸⁾	215,0 ⁽⁶⁾	162,0 ⁽¹⁰⁾	164,0 ⁽⁹⁾	135,0	159,0 ⁽⁷⁾	133,0	152,0 ⁽⁵⁾	124,0	146,0 ⁽⁴⁾		
100	B 154,0 ⁽⁶⁾	175,0 ⁽⁸⁾	133,0 ⁽⁸⁾	135,0 ⁽⁸⁾	143,0 ⁽¹⁰⁾	212,0 ⁽⁸⁾	216,0 ⁽⁸⁾	215,0 ⁽⁶⁾	162,0 ⁽¹⁰⁾	164,0 ⁽⁹⁾	135,0	159,0 ⁽⁷⁾	133,0	152,0 ⁽⁵⁾	124,0	146,0 ⁽⁴⁾		
102	B 154,0 ⁽⁶⁾	175,0 ⁽⁸⁾	133,0 ⁽⁸⁾	135,0 ⁽⁸⁾	143,0 ⁽¹⁰⁾	212,0 ⁽⁸⁾	216,0 ⁽⁸⁾	215,0 ⁽⁶⁾	162,0 ⁽¹⁰⁾	164,0 ⁽⁹⁾	135,0	159,0 ⁽⁷⁾	133,0	152,0 ⁽⁵⁾	124,0	146,0 ⁽⁴⁾		
104	B 154,0 ⁽⁶⁾	175,0 ⁽⁸⁾	133,0 ⁽⁸⁾	135,0 ⁽⁸⁾	143,0 ⁽¹⁰⁾	212,0 ⁽⁸⁾	216,0 ⁽⁸⁾	215,0 ⁽⁶⁾	162,0 ⁽¹⁰⁾	164,0 ⁽⁹⁾	135,0	159,0 ⁽⁷⁾	133,0	152,0 ⁽⁵⁾	124,0	146,0 ⁽⁴⁾		
106	B 154,0 ⁽⁶⁾	175,0 ⁽⁸⁾	133,0 ⁽⁸⁾	135,0														

SDWB/SDWBV/SDWBW

S 72

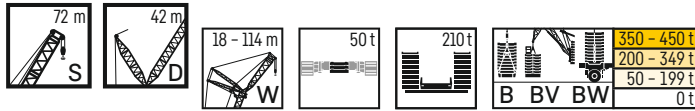

m	S 72 m																
	W 72 m		W 78 m		W 84 m		W 90 m		W 96 m		W 102 m		W 108 m		W 114 m		
	87°/85	WVmax	87°/85	WVmax	87°/85	WVmax	87°/85	WVmax	87°/85	WVmax	87°/85	WVmax	87°/85	WVmax	87°/85	WVmax	
26	B	165,0*	165,0*														
	BV	166,0*	166,0*														
	BW	162,0*	162,0*	145,0*	145,0*												
28	B	163,0*	163,0*	146,0*	146,0*												
	BV	163,0*	163,0*	146,0*	146,0*												
	BW	159,0*	163,0 ⁽¹⁾	143,0*	144,0 ⁽¹⁾	129,0*	129,0*										
30	B	161,0*	165,0 ⁽¹⁾	145,0*	145,0*	130,0*	130,0*										
	BV	162,0	162,0	141,0*	144,0 ⁽¹⁾	128,0*	128,0*	114,0*	114,0*	102,0*	102,0*						
	BW	165,0	165,0	142,0*	142,0*	129,0*	130,0 ⁽¹⁾	115,0*	115,0*	103,0*	103,0*	90,2*	90,2*				
34	B	160,0	160,0	144,0	144,0	126,0*	127,0 ⁽¹⁾	113,0*	113,0*	101,0*	101,0*						
	BV	162,0	163,0 ⁽¹⁾	145,0	145,0	130,0	130,0										
	BW	163,0	163,0	145,0	145,0	127,0*	130,0 ⁽¹⁾	114,0*	114,0*	102,0*	102,0*	89,6*	89,6*				
36	B	158,0	158,0	142,0	142,0	128,0	128,0	112,0*	112,0*	100,0*	101,0 ⁽¹⁾	89,3*	89,5 ⁽¹⁾	80,1*	80,1*		
	BV	160,0	162,0 ⁽¹⁾	143,0	144,0 ⁽¹⁾	129,0	129,0										
	BW	161,0	161,0	144,0	144,0	129,0	129,0	112,0*	113,0 ⁽¹⁾	101,0*	102,0 ⁽¹⁾	88,7*	89,0 ⁽¹⁾	80,4*	80,4*	59,2*	59,2*
38	B	155,0	155,0	140,0	140,0	127,0	127,0	113,0	113,0	101,0	101,0	88,1*	89,1 ⁽¹⁾	79,3*	79,3*	69,1*	69,1*
	BV	158,0	162,0 ⁽¹⁾	142,0	143,0 ⁽¹⁾	128,0	128,0	114,0	114,0	101,0	101,0						
	BW	159,0	159,0	142,0	142,0	128,0	128,0	114,0	114,0	102,0	102,0	87,8*	88,7 ⁽¹⁾	79,7*	79,7*	70,0*	70,0*
40	B	152,0	154,0 ⁽²⁾	138,0	138,0	126,0	126,0	112,0	112,0	100,0	100,0	88,9	88,9	78,4*	78,4*	68,4*	68,8 ⁽¹⁾
	BV	155,0	161,0 ⁽¹⁾	140,0	142,0 ⁽¹⁾	126,0	128,0 ⁽¹⁾	113,0	113,0	100,0	100,0	88,5	88,5				
	BW	156,0	158,0 ⁽²⁾	141,0	141,0	127,0	127,0	113,0	113,0	101,0	101,0	88,7	88,7	78,9*	78,9*	68,8*	69,5 ⁽¹⁾
44	B	145,0	153,0 ⁽²⁾	133,0	136,0 ⁽²⁾	122,0	123,0 ⁽²⁾	110,0	110,0	98,3	98,3	87,4	87,4	78,3	78,3	68,1	68,1
	BV	149,0	158,0 ⁽²⁾	135,0	141,0 ⁽¹⁾	124,0	126,0 ⁽¹⁾	111,0	112,0 ⁽¹⁾	98,7	99,2 ⁽¹⁾	87,0	87,2 ⁽¹⁾	77,3	77,3	67,3	67,3
	BW	150,0	158,0 ⁽²⁾	136,0	140,0 ⁽²⁾	124,0	125,0 ⁽²⁾	111,0	111,0	99,5	99,5	87,2	87,2	79,0	79,0	68,4	68,4
48	B	138,0	153,0 ⁽²⁾	127,0	135,0 ⁽²⁾	118,0	122,0 ⁽²⁾	107,0	108,0 ⁽²⁾	96,2	96,3 ⁽²⁾	85,7	85,7	77,0	77,0	66,8	66,8
	BV	142,0	157,0 ⁽²⁾	130,0	139,0 ⁽²⁾	120,0	124,0 ⁽²⁾	108,0	111,0 ⁽¹⁾	96,8	97,9 ⁽¹⁾	85,4	85,9 ⁽¹⁾	75,8	75,8	66,2	66,2
	BW	143,0	158,0 ⁽²⁾	131,0	139,0 ⁽²⁾	121,0	125,0 ⁽²⁾	109,0	110,0 ⁽²⁾	97,8	98,1 ⁽²⁾	85,8	85,8	77,6	77,6	67,4	67,4
52	B	131,0	149,0 ⁽²⁾	121,0	135,0 ⁽²⁾	113,0	121,0 ⁽²⁾	103,0	108,0 ⁽²⁾	93,2	95,5 ⁽²⁾	84,1	84,4 ⁽²⁾	75,2	75,3 ⁽²⁾	65,7	65,7
	BV	135,0	156,0 ⁽²⁾	125,0	139,0 ⁽²⁾	116,0	124,0 ⁽²⁾	105,0	110,0 ⁽²⁾	94,7	96,6 ⁽¹⁾	83,9	84,7 ⁽¹⁾	74,2	74,2	64,9	65,1 ⁽¹⁾
	BW	136,0	157,0 ⁽²⁾	126,0	139,0 ⁽²⁾	116,0	124,0 ⁽²⁾	106,0	110,0 ⁽²⁾	95,7	97,5 ⁽²⁾	84,4	85,0 ⁽²⁾	76,0	76,2 ⁽²⁾	66,3	66,3
56	B	124,0	146,0 ⁽³⁾	116,0	131,0 ⁽²⁾	108,0	120,0 ⁽²⁾	99,4	107,0 ⁽²⁾	89,7	94,7 ⁽²⁾	82,0	83,6 ⁽²⁾	73,5	74,5 ⁽²⁾	64,4	64,7 ⁽²⁾
	BV	128,0	155,0 ⁽³⁾	119,0	137,0 ⁽²⁾	111,0	123,0 ⁽²⁾	101,0	109,0 ⁽²⁾	91,8	95,9 ⁽²⁾	81,6	83,8 ⁽²⁾	72,4	73,6 ⁽²⁾	63,5	64,0 ⁽¹⁾
	BW	129,0	155,0 ⁽²⁾	120,0	137,0 ⁽²⁾	111,0	124,0 ⁽²⁾	102,0	109,0 ⁽²⁾	92,3	96,9 ⁽²⁾	82,3	84,3 ⁽²⁾	74,4	75,6 ⁽²⁾	65,0	65,5 ⁽²⁾
60	B	117,0	139,0 ⁽⁴⁾	108,0	128,0 ⁽³⁾	103,0	117,0 ⁽³⁾	95,1	105,0 ⁽²⁾	86,5	93,9 ⁽²⁾	79,1	82,9 ⁽²⁾	71,2	73,8 ⁽²⁾	62,7	63,9 ⁽²⁾
	BV	121,0	153,0 ⁽²⁾	113,0	136,0 ⁽²⁾	106,0	121,0 ⁽²⁾	97,4	108,0 ⁽²⁾	88,4	95,3 ⁽²⁾	78,4	83,1 ⁽²⁾	70,4	73,0 ⁽²⁾	61,7	63,3 ⁽²⁾
	BW	122,0	153,0 ⁽²⁾	113,0	136,0 ⁽²⁾	107,0	122,0 ⁽²⁾	98,2	108,0 ⁽²⁾	88,7	96,4 ⁽²⁾	79,2	83,6 ⁽²⁾	72,6	74,9 ⁽²⁾	63,5	64,8 ⁽²⁾
64	B	111,0	132,0 ⁽⁴⁾	103,0	124,0 ⁽⁴⁾	97,9	114,0 ⁽³⁾	90,7	104,0 ⁽³⁾	83,0	92,1 ⁽²⁾	76,1	82,0 ⁽²⁾	68,6	73,1 ⁽²⁾	60,4	63,1 ⁽²⁾
	BV	115,0	150,0 ⁽³⁾	107,0	134,0 ⁽²⁾	101,0	120,0 ⁽³⁾	93,4	107,0 ⁽²⁾	84,0	94,1 ⁽²⁾	75,2	82,3 ⁽²⁾	68,1	72,3 ⁽²⁾	59,4	62,6 ⁽²⁾
	BW	116,0	150,0 ⁽³⁾	108,0	134,0 ⁽²⁾	102,0	121,0 ⁽²⁾	93,9	107,0 ⁽²⁾	85,2	94,9 ⁽²⁾	76,1	82,9 ⁽²⁾	70,4	74,3 ⁽²⁾	61,3	64,1 ⁽²⁾
68	B	105,0	124,0 ⁽⁵⁾	98,2	118,0 ⁽⁴⁾	92,6	101,0 ⁽⁴⁾	86,7	101,0 ⁽²⁾	79,7	90,2 ⁽²⁾	72,8	80,5 ⁽²⁾	65,8	72,0 ⁽²⁾	58,1	62,3 ⁽²⁾
	BV	110,0	147,0 ⁽³⁾	102,0	133,0 ⁽³⁾	96,0	119,0 ⁽³⁾	89,2	106,0 ⁽³⁾	81,1	92,8 ⁽²⁾	72,0	80,9 ⁽²⁾	65,4	71,4 ⁽²⁾	56,9	61,9 ⁽²⁾
	BW	110,0	147,0 ⁽³⁾	103,0	133,0 ⁽³⁾	96,7	120,0 ⁽³⁾	89,7	106,0 ⁽³⁾	81,8	93,3 ⁽²⁾	72,9	81,6 ⁽²⁾	67,3	73,4 ⁽²⁾	58,9	63,5 ⁽²⁾
72	B	100,0	118,0 ⁽⁶⁾	93,1	113,0 ⁽⁵⁾	87,8	106,0 ⁽⁴⁾	81,7	98,6 ⁽²⁾	76,5	88,3 ⁽²⁾	69,1	79,2 ⁽²⁾	63,2	70,5 ⁽²⁾	55,7	61,2 ⁽²⁾
	BV	104,0	142,0 ⁽⁴⁾	97,1	130,0 ⁽³⁾	91,3	118,0 ⁽³⁾	84,9	105,0 ⁽³⁾	77,6	91,5 ⁽²⁾	68,9	79,6 ⁽²⁾	62,7	70,3 ⁽²⁾	54,5	60,8 ⁽²⁾
	BW	104,0	142,0 ⁽⁴⁾	98,3	130,0 ⁽³⁾	91,7	119,0 ⁽³⁾	85,6	105,0 ⁽³⁾	78,4	91,7 ⁽²⁾	69,3	80,4 ⁽²⁾	64,4	72,0 ⁽²⁾	56,7	62,5 ⁽²⁾
76	B	91,1	112,0 ⁽⁷⁾	88,6	107,0 ⁽⁶⁾	83,7	101,0 ⁽⁵⁾	77,9	94,4 ⁽³⁾	72,8	85,2 ⁽³⁾	66,1	77,9 ⁽²⁾	60,6	69,1 ⁽²⁾	53,5	60,0 ⁽²⁾
	BV	92,0	136,0 ⁽⁴⁾	92,1	126,0 ⁽³⁾	87,4	116,0 ⁽³⁾	80,8	104,0 ⁽³⁾	74,2	90,1 ⁽³⁾	65,9	78,3 ⁽²⁾	60,0	69,2 ⁽²⁾	52,1	59,6 ⁽²⁾
	BW	91,9	136,0 ⁽³⁾	92,8	126,0 ⁽³⁾	88,0	117,0 ⁽³⁾	81,8	104,0 ⁽³⁾	75,1	90,4 ⁽³⁾	66,2	79,1 ⁽²⁾	61,8	70,9 ⁽³⁾	54,5	61,4 ⁽²⁾
80	B	75,1	105,0 ⁽⁷⁾	83,1	101,0 ⁽⁶⁾	80,2	97,8 ⁽⁶⁾	74,3	90,3 ⁽⁵⁾	68,0	82,9 ⁽³⁾	63,4	76,0 ⁽³⁾	58,2	67,7 ⁽³⁾	51,4	58,9 ⁽²⁾
	BV	74,7	132,0 ⁽²⁾	84,7	123,0 ⁽²⁾	83,3	114,0 ⁽³⁾	77,5	102,0 ⁽³⁾	70,9	89,1 ⁽³⁾	63,1	76,7 ⁽³⁾	57,4	68,2 ⁽²⁾	49,8	58,5 ⁽²⁾
	BW	75,0	132,0 ⁽²⁾	84,9	123,0 ⁽²⁾	83,8	114,0 ⁽³⁾	78,6	102,0 ⁽³⁾	72,0	89,3 ⁽³⁾	63,5	77,5 ⁽³⁾	59,4	69,7 ⁽³⁾	52,4	60,3 ⁽²⁾
88	B	90,4 ⁽⁸⁾		89,0 ⁽⁸⁾	68,6	86,8 ⁽⁷⁾	67,5	82,7 ⁽⁷⁾	62,1	76,7 ⁽⁴⁾	58,2	70,7 ⁽³⁾	53,6	65,5 ⁽³⁾	46,8	56,4 ⁽³⁾	
	BV	119,0 ⁽³⁾		116,0 ⁽²⁾	69,1	108,0 ⁽³⁾	70,3	98,0 ⁽⁵⁾	65,0	86,0 ⁽³⁾	57,7	74,3 ⁽³⁾	52,5	66,0 ⁽³⁾	45,4	55,8 ⁽²⁾	
	BW	119,0 ⁽³⁾		116,0 ⁽²⁾	68,8	108,0 ⁽³⁾	70,4	97,8 ⁽⁵⁾	65,3	86,1 ⁽³⁾	58,5	74,8 ⁽³⁾	54,8	67,3 ⁽³⁾	47,9	57,8 ⁽³⁾	
96	B	77,6 ⁽¹⁰⁾		79,3 ⁽¹⁰⁾		77,1 ⁽⁸⁾	54,3	74,3 ⁽⁸⁾	56,5	70,3 ⁽⁷⁾	53,5	65,8 ⁽⁵⁾	49,2	62,0 ⁽⁴⁾	42,1	53,6 ⁽⁴⁾	
	BV	107,0 ⁽⁵⁾		104,0 ⁽⁴⁾		103,0 ⁽³⁾	53,5	93,8 ⁽³⁾	57,8	82,8 ⁽³⁾	53,0	71,5 ⁽³⁾	48,1	63,6 ⁽³⁾	41,4	53,8 ⁽³⁾	
	BW	106,0 ⁽⁵⁾		104,0 ⁽⁴⁾		103,0 ⁽³⁾	54,3	93,3 ⁽³⁾	58,3	82,9 ⁽³⁾	54,0	71,8 ⁽³⁾	50,6	64,9 ⁽³⁾	43,0	55,9 ⁽³⁾	
104	B	63,4 ⁽¹¹⁾		66,0 ⁽¹⁰⁾		67,2 ⁽¹⁰⁾		66,3 ⁽⁹⁾	40,0	64,1 ⁽⁸⁾	46,6	60,7 ⁽⁶⁾	44,1	57,2 ⁽⁵⁾	38,8	50,9 ⁽⁵⁾	
	BV	92,9 ⁽⁸⁾		90,2 ⁽⁵⁾		90,4 ⁽⁴⁾		86,8 ⁽³⁾	39,8	79,6 ⁽³⁾	45,6	68,8 ⁽³⁾	44,0	61,2 ⁽⁴⁾	37,8	51,7 ⁽³⁾	
	BW	92,8 ⁽⁷⁾		90,3 ⁽⁴⁾		89,7 ⁽³⁾		86,2 ⁽³⁾	40,2	79,8 ⁽³⁾	45,8	68,9 ⁽⁴⁾	45,6	62,6 ⁽⁴⁾	39,7	53,9 ⁽³⁾	
112	B	49,6 ⁽⁹⁾		51,3 ⁽⁹⁾		55,6 ⁽¹⁰⁾		56,5 ⁽¹⁰⁾		57,1 ⁽⁹⁾		56,2 ⁽⁸⁾	37,4	53,0 ⁽⁷⁾	35,4	48,6 ⁽⁶⁾	
	BV	79,7 ⁽⁸⁾		77,9 ⁽⁸⁾		77,9 ⁽⁴⁾		76,0 ⁽⁴⁾		72,8 ⁽⁴⁾		66,3 ⁽⁴⁾	35,3	59,4 ⁽⁴⁾	34,0	50,1 ⁽⁴⁾	
	BW	80,2 ⁽⁸⁾		78,0 ⁽⁸⁾		77,2 ⁽⁵⁾		75,9 ⁽⁴⁾		73,4 ⁽⁴⁾		66,1 ⁽⁴⁾	37,4	60,9 ⁽⁴⁾	36,2	52,1 ⁽⁴⁾	
120	B	36,9 ⁽⁷⁾		39,8 ⁽⁹⁾		43,4 ⁽⁹⁾		45,9 ⁽¹⁰⁾		47,0 ⁽⁹⁾		48,7 ⁽⁹⁾		46,5 ⁽⁸⁾	28,1	43,5 ⁽⁷⁾	
	BV	65,9 ⁽⁷⁾		67,7 ⁽⁸⁾		67,3 ⁽⁶⁾		65,7 ⁽⁴⁾		64,3 ⁽⁴⁾		61,2 ⁽⁴⁾		57,5 ⁽⁴⁾	25,9		

SDWB/SDWBV/SDWBW

S 78

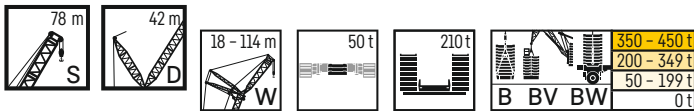

m	S 78 m																	
	W 18 m		W 24 m		W 30 m		W 36 m		W 42 m		W 48 m		W 54 m		W 60 m		W 66 m	
	87°/85	WVmax	87°/85	WVmax	87°/85	WVmax	87°/85	WVmax	87°/85	WVmax	87°/85	WVmax	87°/85	WVmax	87°/85	WVmax	87°/85	WVmax
14	B	405,0*	405,0*															
	BV	408,0*	408,0*															
	BW	386,0*	407,0 ⁽¹⁾	352,0*	352,0*													
16	B	391,0*	414,0 ⁽¹⁾	355,0*	355,0*													
	BV	399,0	404,0 ⁽¹⁾	336,0*	356,0 ⁽¹⁾	316,0*	324,0 ⁽¹⁾	288,0*	288,0*									
	BW	402,0	412,0 ⁽¹⁾															
18	B	404,0	414,0 ⁽¹⁾	340,0*	350,0 ⁽¹⁾	319,0*	327,0 ⁽¹⁾	290,0*	290,0*									
	BV	382,0	403,0 ⁽¹⁾	351,0	351,0	327,0	327,0	280,0*	289,0 ⁽¹⁾	256,0*	256,0*							
	BW	384,0	412,0 ⁽¹⁾	351,0	361,0 ⁽¹⁾	331,0	331,0											
20	B	386,0	414,0 ⁽¹⁾	353,0	353,0	332,0	332,0	282,0*	292,0 ⁽¹⁾	257,0*	257,0*							
	BV	366,0	402,0 ⁽¹⁾	337,0	345,0 ⁽²⁾	317,0	320,0 ⁽¹⁾	291,0	291,0	250,0*	250,0*	228,0*	228,0*	208,0*	208,0*			
	BW	366,0	412,0 ⁽¹⁾	337,0	361,0 ⁽¹⁾	321,0	329,0 ⁽¹⁾	293,0	293,0									
22	B	369,0	414,0 ⁽¹⁾	339,0	350,0 ⁽²⁾	323,0	330,0 ⁽¹⁾	295,0	295,0	251,0*	261,0 ⁽¹⁾	229,0*	229,0*	209,0*	209,0*			
	BV	351,0	401,0 ⁽¹⁾	323,0	343,0 ⁽²⁾	306,0	319,0 ⁽¹⁾	281,0	285,0 ⁽¹⁾	258,0	258,0	222,0*	230,0 ⁽¹⁾	202,0*	205,0 ⁽¹⁾	184,0*	184,0*	
	BW	350,0	412,0 ⁽¹⁾	322,0	360,0 ⁽¹⁾	311,0	329,0 ⁽¹⁾	286,0	293,0 ⁽¹⁾	261,0	261,0							
24	B	353,0	414,0 ⁽¹⁾	325,0	349,0 ⁽²⁾	312,0	330,0 ⁽¹⁾	287,0	294,0 ⁽¹⁾	263,0	263,0	224,0*	234,0 ⁽¹⁾	205,0*	208,0 ⁽¹⁾	186,0*	186,0*	
	BV	325,0	390,0 ⁽¹⁾	309,0	341,0 ⁽²⁾	294,0	319,0 ⁽¹⁾	271,0	284,0 ⁽¹⁾	250,0	254,0 ⁽¹⁾	229,0	229,0	197,0*	206,0 ⁽¹⁾	180,0*	184,0 ⁽¹⁾	164,0*
	BW	328,0	409,0 ⁽¹⁾	309,0	360,0 ⁽¹⁾	300,0	328,0 ⁽¹⁾	276,0	292,0 ⁽¹⁾	254,0	261,0 ⁽¹⁾	233,0	233,0					
26	B	329,0	403,0 ⁽²⁾	311,0	349,0 ⁽²⁾	302,0	330,0 ⁽¹⁾	278,0	293,0 ⁽¹⁾	256,0	262,0 ⁽¹⁾	234,0	235,0 ⁽¹⁾	200,0*	209,0 ⁽¹⁾	182,0*	186,0 ⁽¹⁾	166,0*
	BV	371,0 ⁽³⁾	295,0	339,0 ⁽²⁾	281,0	319,0 ⁽¹⁾	262,0	284,0 ⁽¹⁾	242,0	254,0 ⁽¹⁾	223,0	227,0 ⁽¹⁾	204,0	204,0	176,0*	184,0 ⁽¹⁾	160,0*	165,0 ⁽¹⁾
	BW	404,0 ⁽¹⁾	295,0	357,0 ⁽¹⁾	288,0	328,0 ⁽¹⁾	267,0	291,0 ⁽¹⁾	246,0	260,0 ⁽¹⁾	227,0	233,0 ⁽¹⁾	208,0	208,0	189,0	189,0		
28	B	400,0 ⁽²⁾	297,0	349,0 ⁽²⁾	290,0	330,0 ⁽¹⁾	268,0	293,0 ⁽¹⁾	248,0	262,0 ⁽¹⁾	228,0	234,0 ⁽¹⁾	209,0	209,0	178,0*	187,0 ⁽¹⁾	162,0*	167,0 ⁽¹⁾
	BV	351,0 ⁽⁴⁾	283,0	332,0 ⁽²⁾	271,0	316,0 ⁽¹⁾	252,0	285,0 ⁽¹⁾	233,0	253,0 ⁽¹⁾	216,0	226,0 ⁽¹⁾	199,0	204,0 ⁽¹⁾	182,0	182,0	167,0	167,0
	BW	398,0 ⁽¹⁾	284,0	348,0 ⁽¹⁾	277,0	328,0 ⁽¹⁾	257,0	291,0 ⁽¹⁾	238,0	260,0 ⁽¹⁾	220,0	233,0 ⁽¹⁾	203,0	208,0 ⁽¹⁾	185,0	185,0	168,0	168,0
30	B	397,0 ⁽²⁾	286,0	348,0 ⁽²⁾	279,0	328,0 ⁽¹⁾	259,0	292,0 ⁽¹⁾	240,0	261,0 ⁽¹⁾	222,0	234,0 ⁽¹⁾	204,0	204,0	186,0	186,0	169,0	169,0
	BV	331,0 ⁽⁷⁾	263,0	316,0 ⁽³⁾	260,0	302,0 ⁽²⁾	242,0	282,0 ⁽¹⁾	226,0	253,0 ⁽¹⁾	209,0	226,0 ⁽¹⁾	193,0	203,0 ⁽¹⁾	178,0	178,0	164,0	164,0
	BW	393,0 ⁽¹⁾	264,0	346,0 ⁽²⁾	265,0	326,0 ⁽¹⁾	248,0	290,0 ⁽¹⁾	230,0	259,0 ⁽¹⁾	214,0	232,0 ⁽¹⁾	197,0	208,0 ⁽¹⁾	181,0	186,0 ⁽¹⁾	165,0	167,0 ⁽¹⁾
32	B	394,0 ⁽²⁾	264,0	348,0 ⁽²⁾	268,0	328,0 ⁽¹⁾	249,0	291,0 ⁽¹⁾	232,0	260,0 ⁽¹⁾	215,0	233,0 ⁽¹⁾	198,0	199,0 ⁽²⁾	182,0	182,0	167,0	167,0
	BV	312,0 ⁽⁹⁾		300,0 ⁽⁵⁾	250,0	289,0 ⁽¹⁾	233,0	272,0 ⁽¹⁾	218,0	253,0 ⁽¹⁾	203,0	225,0 ⁽¹⁾	188,0	202,0 ⁽¹⁾	174,0	174,0	160,0	160,0
	BW	383,0 ⁽¹⁾		346,0 ⁽²⁾	255,0	325,0 ⁽¹⁾	238,0	290,0 ⁽¹⁾	222,0	258,0 ⁽¹⁾	207,0	231,0 ⁽¹⁾	192,0	207,0 ⁽¹⁾	177,0	185,0 ⁽¹⁾	162,0	166,0 ⁽¹⁾
34	B	380,0 ⁽³⁾		349,0 ⁽²⁾	257,0	328,0 ⁽¹⁾	240,0	291,0 ⁽¹⁾	224,0	259,0 ⁽¹⁾	208,0	232,0 ⁽¹⁾	193,0	199,0 ⁽²⁾	178,0	178,0	163,0	163,0
	BV	294,0 ⁽⁹⁾		288,0 ⁽⁶⁾	242,0	276,0 ⁽³⁾	225,0	263,0 ⁽²⁾	210,0	243,0 ⁽¹⁾	196,0	225,0 ⁽¹⁾	182,0	202,0 ⁽¹⁾	169,0	172,0 ⁽²⁾	156,0	156,0
	BW	369,0 ⁽³⁾		345,0 ⁽²⁾	246,0	323,0 ⁽¹⁾	229,0	290,0 ⁽¹⁾	215,0	258,0 ⁽¹⁾	200,0	230,0 ⁽¹⁾	186,0	206,0 ⁽¹⁾	172,0	185,0 ⁽¹⁾	159,0	165,0 ⁽¹⁾
36	B	361,0 ⁽⁵⁾		349,0 ⁽²⁾	248,0	328,0 ⁽¹⁾	231,0	290,0 ⁽¹⁾	216,0	253,0 ⁽¹⁾	202,0	231,0 ⁽¹⁾	187,0	199,0 ⁽²⁾	174,0	178,0 ⁽²⁾	160,0	160,0
	BV	275,0 ⁽⁹⁾		276,0 ⁽⁸⁾	233,0	264,0 ⁽⁴⁾	218,0	252,0 ⁽³⁾	203,0	239,0 ⁽²⁾	190,0	220,0 ⁽¹⁾	177,0	201,0 ⁽¹⁾	165,0	172,0 ⁽²⁾	153,0	154,0 ⁽²⁾
	BW	356,0 ⁽⁵⁾		343,0 ⁽²⁾	236,0	322,0 ⁽¹⁾	221,0	291,0 ⁽¹⁾	207,0	258,0 ⁽¹⁾	194,0	230,0 ⁽¹⁾	181,0	206,0 ⁽¹⁾	168,0	184,0 ⁽¹⁾	155,0	165,0 ⁽¹⁾
38	B	346,0 ⁽⁷⁾		347,0 ⁽²⁾	237,0	328,0 ⁽¹⁾	223,0	290,0 ⁽¹⁾	208,0	249,0 ⁽²⁾	195,0	225,0 ⁽¹⁾	182,0	198,0 ⁽²⁾	169,0	178,0 ⁽²⁾	156,0	159,0 ⁽²⁾
	BV	256,0 ⁽¹⁰⁾		262,0 ⁽⁹⁾		254,0 ⁽⁶⁾	211,0	242,0 ⁽⁴⁾	196,0	230,0 ⁽²⁾	184,0	216,0 ⁽²⁾	172,0	196,0 ⁽¹⁾	160,0	172,0 ⁽²⁾	149,0	154,0 ⁽²⁾
	BW	340,0 ⁽⁶⁾		331,0 ⁽³⁾		313,0 ⁽¹⁾	213,0	291,0 ⁽¹⁾	199,0	258,0 ⁽¹⁾	187,0	229,0 ⁽¹⁾	175,0	205,0 ⁽¹⁾	163,0	184,0 ⁽¹⁾	151,0	164,0 ⁽¹⁾
40	B	293,0 ⁽¹⁰⁾		334,0 ⁽³⁾		319,0 ⁽¹⁾	215,0	290,0 ⁽¹⁾	201,0	249,0 ⁽²⁾	188,0	222,0 ⁽²⁾	176,0	198,0 ⁽²⁾	164,0	178,0 ⁽²⁾	152,0	159,0 ⁽²⁾
	BV	233,0 ⁽⁹⁾		233,0 ⁽⁹⁾		234,0 ⁽⁹⁾	197,0	224,0 ⁽⁵⁾	184,0	214,0 ⁽³⁾	172,0	204,0 ⁽³⁾	162,0	189,0 ⁽²⁾	151,0	173,0 ⁽²⁾	141,0	154,0 ⁽²⁾
	BW	308,0 ⁽⁷⁾		305,0 ⁽⁵⁾		294,0 ⁽⁵⁾	199,0	284,0 ⁽²⁾	186,0	258,0 ⁽¹⁾	174,0	228,0 ⁽¹⁾	164,0	203,0 ⁽¹⁾	154,0	176,0 ⁽²⁾	144,0	158,0 ⁽²⁾
44	B			305,0 ⁽⁴⁾		300,0 ⁽⁵⁾	200,0	282,0 ⁽²⁾	188,0	250,0 ⁽²⁾	176,0	222,0 ⁽²⁾	166,0	198,0 ⁽²⁾	155,0	177,0 ⁽²⁾	145,0	159,0 ⁽²⁾
	BV			208,0 ⁽¹⁾		212,0 ⁽¹⁰⁾		207,0 ⁽⁸⁾	173,0	198,0 ⁽³⁾	162,0	191,0 ⁽⁴⁾	152,0	180,0 ⁽³⁾	143,0	167,0 ⁽²⁾	133,0	154,0 ⁽²⁾
	BW	277,0 ⁽⁹⁾		278,0 ⁽⁵⁾		275,0 ⁽⁵⁾		267,0 ⁽⁵⁾	175,0	248,0 ⁽²⁾	164,0	224,0 ⁽¹⁾	154,0	201,0 ⁽¹⁾	145,0	177,0 ⁽²⁾	136,0	158,0 ⁽²⁾
48	B			275,0 ⁽⁵⁾		275,0 ⁽⁴⁾		267,0 ⁽⁴⁾	176,0	248,0 ⁽²⁾	166,0	223,0 ⁽²⁾	155,0	199,0 ⁽²⁾	146,0	177,0 ⁽²⁾	137,0	158,0 ⁽²⁾
	BV			188,0 ⁽¹¹⁾		189,0 ⁽¹¹⁾		193,0 ⁽¹¹⁾		186,0 ⁽⁷⁾	153,0	178,0 ⁽⁵⁾	143,0	170,0 ⁽⁴⁾	134,0	160,0 ⁽³⁾	126,0	148,0 ⁽³⁾
	BW	246,0 ⁽⁸⁾		251,0 ⁽⁵⁾		253,0 ⁽⁶⁾		250,0 ⁽⁵⁾		237,0 ⁽³⁾	154,0	219,0 ⁽²⁾	144,0	199,0 ⁽²⁾	136,0	177,0 ⁽²⁾	128,0	158,0 ⁽³⁾
52	B			251,0 ⁽⁵⁾		253,0 ⁽⁶⁾		250,0 ⁽⁴⁾		236,0 ⁽³⁾	155,0	218,0 ⁽²⁾	146,0	199,0 ⁽²⁾	137,0	177,0 ⁽²⁾	129,0	158,0 ⁽³⁾
	BV			168,0 ⁽¹⁾		170,0 ⁽¹⁰⁾		174,0 ⁽¹¹⁾		172,0 ⁽¹⁰⁾	142,0	167,0 ⁽⁷⁾	135,0	160,0 ⁽⁵⁾	127,0	152,0 ⁽⁴⁾	119,0	142,0 ⁽³⁾
	BW	222,0 ⁽⁷⁾		229,0 ⁽¹⁾		232,0 ⁽⁸⁾		231,0 ⁽⁸⁾		228,0 ⁽⁵⁾	143,0	210,0 ⁽³⁾	137,0	194,0 ⁽²⁾	129,0	177,0 ⁽²⁾	121,0	157,0 ⁽²⁾
56	B			225,0 ⁽⁶⁾		232,0 ⁽⁸⁾		231,0 ⁽⁸⁾		227,0 ⁽⁵⁾	144,0	209,0 ⁽³⁾	138,0	193,0 ⁽²⁾	130,0	177,0 ⁽²⁾	122,0	158,0 ⁽²⁾
	BV			147,0 ⁽¹⁾		153,0 ⁽¹⁰⁾		157,0 ⁽¹⁰⁾		160,0 ⁽¹¹⁾		156,0 ⁽⁹⁾	129,0	150,0 ⁽⁷⁾	120,0	144,0 ⁽⁶⁾	112,0	135,0 ⁽⁴⁾
	BW	203,0 ⁽⁷⁾		211,0 ⁽¹⁾														

SDWB/SDWBV/SDWBW

S 78

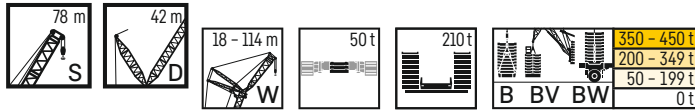

m	S 78 m																
	W 72 m		W 78 m		W 84 m		W 90 m		W 96 m		W 102 m		W 108 m		W 114 m		
	87°/85	WVmax	87°/85	WVmax	87°/85	WVmax	87°/85	WVmax	87°/85	WVmax	87°/85	WVmax	87°/85	WVmax	87°/85	WVmax	
28	B	146,0*	146,0*	133,0*	133,0*												
	BV																
	BW	147,0*	147,0*	133,0*	133,0*												
30	B	143,0*	147,0 ⁽¹⁾	130,0*	130,0*	118,0*	118,0*										
	BV																
	BW	144,0*	144,0*	131,0*	131,0*	118,0*	118,0*										
32	B	148,0	148,0	128,0*	131,0 ⁽¹⁾	116,0*	117,0 ⁽¹⁾	104,0*	104,0*	92,0*	92,0*						
	BV	149,0	149,0														
	BW	145,0	145,0	129,0*	132,0 ⁽¹⁾	116,0*	118,0 ⁽¹⁾	105,0*	105,0*	85,6*	85,6*						
34	B	146,0	146,0	131,0	131,0	114,0*	117,0 ⁽¹⁾	103,0*	104,0 ⁽¹⁾	91,6*	91,6*	82,7*	82,7*				
	BV	147,0	148,0 ⁽¹⁾	132,0	132,0												
	BW	148,0	148,0	133,0	133,0	114,0*	118,0 ⁽¹⁾	103,0*	105,0 ⁽¹⁾	91,9*	91,9*	82,9*	82,9*				
36	B	143,0	143,0	130,0	130,0	117,0	117,0	101,0*	104,0 ⁽¹⁾	90,2*	91,5 ⁽¹⁾	81,8*	81,8*	73,5*	73,5*		
	BV	145,0	147,0 ⁽¹⁾	131,0	132,0 ⁽¹⁾	117,0	117,0										
	BW	146,0	146,0	132,0	132,0	118,0	118,0	102,0*	105,0 ⁽¹⁾	90,7*	92,0 ⁽¹⁾	82,0*	82,0*	73,7*	73,7*		
38	B	140,0	140,0	128,0	128,0	115,0	115,0	104,0	104,0	88,7*	91,3 ⁽¹⁾	80,8*	81,7 ⁽¹⁾	72,7*	73,0 ⁽¹⁾	63,1*	63,1*
	BV	142,0	147,0 ⁽¹⁾	129,0	131,0 ⁽¹⁾	116,0	117,0 ⁽¹⁾	104,0	104,0	92,3	92,3						
	BW	143,0	143,0	130,0	130,0	117,0	117,0	105,0	105,0	89,4*	91,9 ⁽¹⁾	81,1*	82,1 ⁽¹⁾	72,9*	73,3 ⁽¹⁾	63,3*	63,3*
40	B	137,0	137,0	126,0	126,0	114,0	114,0	103,0	103,0	90,9	90,9	81,7	81,7	71,8*	72,7 ⁽¹⁾	62,4*	62,7 ⁽¹⁾
	BV	139,0	146,0 ⁽¹⁾	127,0	130,0 ⁽¹⁾	115,0	116,0 ⁽¹⁾	103,0	103,0	91,5	91,5	80,6	80,6				
	BW	140,0	142,0 ⁽²⁾	128,0	128,0	115,0	115,0	104,0	104,0	91,7	91,7	82,3	82,3	72,0*	73,1 ⁽¹⁾	62,6*	63,0 ⁽¹⁾
44	B	130,0	138,0 ⁽²⁾	121,0	124,0 ⁽²⁾	110,0	110,0	100,0	100,0	89,0	89,0	80,3	80,3	72,0	72,0	62,4	62,4
	BV	133,0	145,0 ⁽¹⁾	122,0	129,0 ⁽¹⁾	111,0	115,0 ⁽¹⁾	101,0	102,0 ⁽¹⁾	89,8	90,4 ⁽¹⁾	79,3	79,4 ⁽¹⁾	70,3	70,3	61,1	61,1
	BW	134,0	142,0 ⁽²⁾	123,0	127,0 ⁽²⁾	112,0	113,0 ⁽²⁾	101,0	101,0	90,1	90,1	81,0	81,0	72,6	72,6	62,8	62,8
48	B	124,0	138,0 ⁽²⁾	115,0	123,0 ⁽²⁾	106,0	110,0 ⁽²⁾	96,5	97,8 ⁽²⁾	86,8	86,9 ⁽²⁾	78,8	78,8	70,4	70,4	61,3	61,3
	BV	126,0	141,0 ⁽²⁾	117,0	126,0 ⁽²⁾	107,0	114,0 ⁽¹⁾	97,5	101,0 ⁽¹⁾	87,6	89,3 ⁽¹⁾	77,7	78,4 ⁽¹⁾	69,1	69,1	60,0	60,1 ⁽¹⁾
	BW	127,0	142,0 ⁽²⁾	118,0	127,0 ⁽²⁾	108,0	113,0 ⁽²⁾	98,6	101,0 ⁽²⁾	88,1	88,4 ⁽²⁾	79,6	79,6	71,0	71,0	61,8	61,8
52	B	117,0	136,0 ⁽²⁾	109,0	123,0 ⁽²⁾	101,0	110,0 ⁽²⁾	92,9	97,6 ⁽²⁾	83,9	85,7 ⁽²⁾	76,8	77,4 ⁽²⁾	68,2	68,2	60,2	60,2
	BV	120,0	141,0 ⁽²⁾	111,0	126,0 ⁽²⁾	103,0	112,0 ⁽²⁾	94,1	99,2 ⁽²⁾	84,9	88,3 ⁽¹⁾	75,6	77,4 ⁽¹⁾	67,6	67,6	58,9	59,2 ⁽¹⁾
	BW	121,0	141,0 ⁽²⁾	112,0	127,0 ⁽²⁾	104,0	112,0 ⁽²⁾	94,9	100,0 ⁽²⁾	85,5	88,1 ⁽²⁾	77,8	78,7 ⁽²⁾	69,0	69,0	60,8	60,8
56	B	111,0	131,0 ⁽³⁾	104,0	120,0 ⁽²⁾	97,1	109,0 ⁽²⁾	88,5	97,4 ⁽²⁾	81,0	85,5 ⁽²⁾	74,3	76,4 ⁽²⁾	66,4	67,5 ⁽²⁾	58,9	59,3 ⁽²⁾
	BV	113,0	140,0 ⁽²⁾	106,0	125,0 ⁽²⁾	98,3	112,0 ⁽²⁾	90,4	99,0 ⁽²⁾	82,0	87,2 ⁽²⁾	73,3	76,2 ⁽²⁾	65,7	67,2 ⁽²⁾	57,5	58,2 ⁽¹⁾
	BW	114,0	140,0 ⁽²⁾	107,0	126,0 ⁽²⁾	99,4	112,0 ⁽²⁾	90,8	99,2 ⁽²⁾	82,8	87,7 ⁽²⁾	75,8	78,2 ⁽²⁾	67,3	68,5 ⁽²⁾	59,6	60,0 ⁽²⁾
60	B	106,0	126,0 ⁽³⁾	99,0	117,0 ⁽³⁾	92,4	107,0 ⁽²⁾	84,9	96,3 ⁽²⁾	77,8	85,3 ⁽²⁾	71,8	76,0 ⁽²⁾	64,4	66,8 ⁽²⁾	57,3	58,6 ⁽²⁾
	BV	107,0	139,0 ⁽³⁾	100,0	124,0 ⁽²⁾	93,5	111,0 ⁽²⁾	86,3	98,3 ⁽²⁾	78,8	86,9 ⁽²⁾	70,8	75,7 ⁽²⁾	63,7	66,7 ⁽²⁾	55,8	57,4 ⁽²⁾
	BW	108,0	139,0 ⁽²⁾	101,0	125,0 ⁽²⁾	94,2	111,0 ⁽²⁾	86,9	99,4 ⁽²⁾	79,8	87,3 ⁽²⁾	73,3	77,8 ⁽²⁾	65,5	68,1 ⁽²⁾	58,1	59,4 ⁽²⁾
64	B	100,0	121,0 ⁽⁴⁾	94,2	112,0 ⁽²⁾	87,5	104,0 ⁽²⁾	81,5	93,8 ⁽²⁾	74,7	83,9 ⁽²⁾	68,6	75,6 ⁽²⁾	62,2	66,2 ⁽²⁾	55,4	58,0 ⁽²⁾
	BV	101,0	138,0 ⁽²⁾	94,8	123,0 ⁽²⁾	88,7	109,0 ⁽²⁾	82,2	97,3 ⁽²⁾	75,5	86,1 ⁽²⁾	68,2	75,3 ⁽²⁾	61,5	66,3 ⁽²⁾	53,9	56,8 ⁽²⁾
	BW	102,0	138,0 ⁽²⁾	95,9	124,0 ⁽²⁾	89,1	110,0 ⁽²⁾	83,0	98,2 ⁽²⁾	76,6	86,5 ⁽²⁾	70,3	77,4 ⁽²⁾	63,5	67,6 ⁽²⁾	56,3	58,9 ⁽²⁾
68	B	94,3	116,0 ⁽⁵⁾	89,2	108,0 ⁽³⁾	83,5	102,0 ⁽²⁾	77,6	91,2 ⁽²⁾	71,0	82,5 ⁽²⁾	65,4	74,1 ⁽²⁾	60,0	65,6 ⁽²⁾	53,4	57,3 ⁽²⁾
	BV	96,1	137,0 ⁽³⁾	90,0	122,0 ⁽³⁾	84,0	108,0 ⁽²⁾	78,1	96,7 ⁽²⁾	72,0	84,9 ⁽²⁾	65,4	74,2 ⁽²⁾	59,3	65,7 ⁽²⁾	51,7	56,3 ⁽²⁾
	BW	97,5	137,0 ⁽³⁾	90,5	122,0 ⁽³⁾	84,8	109,0 ⁽²⁾	79,0	97,0 ⁽²⁾	73,3	85,4 ⁽²⁾	67,0	76,3 ⁽²⁾	61,4	67,1 ⁽²⁾	54,3	58,4 ⁽²⁾
72	B	89,8	110,0 ⁽⁶⁾	84,6	103,0 ⁽³⁾	79,8	97,1 ⁽³⁾	74,1	88,6 ⁽²⁾	67,4	81,1 ⁽²⁾	62,9	72,9 ⁽³⁾	57,5	64,4 ⁽²⁾	51,4	56,3 ⁽²⁾
	BV	91,0	133,0 ⁽³⁾	85,8	122,0 ⁽³⁾	79,7	108,0 ⁽³⁾	74,1	94,2 ⁽²⁾	68,5	83,7 ⁽²⁾	62,4	73,0 ⁽²⁾	56,9	64,6 ⁽²⁾	49,5	55,2 ⁽¹⁾
	BW	91,9	133,0 ⁽⁴⁾	86,6	123,0 ⁽³⁾	80,8	108,0 ⁽³⁾	75,3	95,2 ⁽²⁾	69,4	84,2 ⁽²⁾	64,1	75,1 ⁽²⁾	59,2	66,1 ⁽²⁾	52,2	57,7 ⁽²⁾
76	B	85,0	105,0 ⁽⁷⁾	80,4	98,9 ⁽⁴⁾	76,1	93,6 ⁽³⁾	70,6	85,1 ⁽³⁾	64,3	79,5 ⁽²⁾	60,4	71,4 ⁽²⁾	55,4	63,4 ⁽³⁾	48,7	55,3 ⁽²⁾
	BV	86,3	129,0 ⁽⁴⁾	81,3	119,0 ⁽³⁾	76,2	107,0 ⁽³⁾	70,2	94,3 ⁽³⁾	65,0	82,6 ⁽³⁾	59,4	71,8 ⁽²⁾	54,3	63,5 ⁽²⁾	47,3	54,4 ⁽²⁾
	BW	86,6	129,0 ⁽⁴⁾	82,3	119,0 ⁽³⁾	77,5	107,0 ⁽³⁾	71,6	95,5 ⁽³⁾	65,5	83,2 ⁽³⁾	61,4	73,9 ⁽²⁾	56,7	65,0 ⁽²⁾	49,6	56,7 ⁽²⁾
80	B	77,6	99,5 ⁽⁸⁾	76,7	94,9 ⁽⁷⁾	71,3	88,0 ⁽⁴⁾	66,4	81,9 ⁽⁴⁾	61,5	77,0 ⁽³⁾	57,5	69,6 ⁽³⁾	53,2	62,5 ⁽³⁾	45,9	54,3 ⁽²⁾
	BV	77,6	125,0 ⁽⁵⁾	77,2	116,0 ⁽⁴⁾	72,4	105,0 ⁽³⁾	67,1	94,3 ⁽³⁾	61,7	81,8 ⁽³⁾	56,5	70,5 ⁽³⁾	51,8	62,4 ⁽²⁾	45,1	53,4 ⁽²⁾
	BW	78,0	125,0 ⁽⁵⁾	78,3	116,0 ⁽⁴⁾	73,5	105,0 ⁽³⁾	67,9	94,8 ⁽³⁾	62,4	82,4 ⁽³⁾	58,5	72,9 ⁽³⁾	54,3	64,0 ⁽²⁾	46,7	55,7 ⁽²⁾
88	B		87,4 ⁽¹⁰⁾		84,4 ⁽⁹⁾	64,1	80,8 ⁽⁸⁾	59,8	75,6 ⁽⁵⁾	56,1	71,7 ⁽⁴⁾	52,8	65,4 ⁽⁵⁾	48,4	60,8 ⁽³⁾	41,9	52,3 ⁽³⁾
	BV		114,0 ⁽²⁾		109,0 ⁽²⁾	65,4	101,0 ⁽³⁾	60,7	90,9 ⁽³⁾	56,1	79,6 ⁽³⁾	50,9	68,6 ⁽³⁾	46,6	60,7 ⁽³⁾	41,0	51,1 ⁽³⁾
	BW		114,0 ⁽³⁾		109,0 ⁽³⁾	65,6	101,0 ⁽³⁾	61,6	91,2 ⁽³⁾	57,3	80,1 ⁽³⁾	53,3	70,7 ⁽³⁾	49,3	62,4 ⁽³⁾	42,7	53,6 ⁽³⁾
96	B		76,6 ⁽¹¹⁾		75,6 ⁽¹⁰⁾		73,3 ⁽⁹⁾	53,3	69,0 ⁽⁶⁾	50,6	64,9 ⁽⁵⁾	47,8	60,9 ⁽⁵⁾	43,0	57,9 ⁽⁴⁾	38,3	49,6 ⁽⁴⁾
	BV		103,0 ⁽⁵⁾		101,0 ⁽⁵⁾		96,4 ⁽⁵⁾	53,3	87,7 ⁽³⁾	50,7	77,0 ⁽³⁾	46,4	66,3 ⁽⁵⁾	42,2	58,7 ⁽³⁾	37,1	49,4 ⁽³⁾
	BW		103,0 ⁽⁵⁾		101,0 ⁽⁵⁾		96,7 ⁽⁵⁾	54,2	87,7 ⁽³⁾	52,1	77,5 ⁽³⁾	48,5	68,0 ⁽⁵⁾	43,7	60,4 ⁽³⁾	39,3	51,8 ⁽³⁾
104	B		62,4 ⁽¹¹⁾		65,3 ⁽¹¹⁾		65,3 ⁽¹⁰⁾		63,1 ⁽⁹⁾	41,7	60,0 ⁽⁷⁾	42,0	56,8 ⁽⁶⁾	39,4	53,9 ⁽⁵⁾	35,1	46,1 ⁽⁵⁾
	BV		92,1 ⁽⁷⁾		90,2 ⁽⁶⁾		88,8 ⁽⁴⁾		84,0 ⁽³⁾	41,8	75,1 ⁽⁴⁾	41,8	64,2 ⁽⁴⁾				

SDWB/SDWBV/SDWBW

S 84

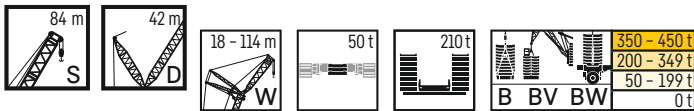

m	S 84 m																	
	W 18 m		W 24 m		W 30 m		W 36 m		W 42 m		W 48 m		W 54 m		W 60 m		W 66 m	
	87°/85	WVmax	87°/85	WVmax	87°/85	WVmax	87°/85	WVmax	87°/85	WVmax	87°/85	WVmax	87°/85	WVmax	87°/85	WVmax	87°/85	WVmax
14	B 361,0*	361,0*																
16	B 345,0*	361,0 ⁽¹⁾	314,0*	314,0*														
18	B 357,0	360,0 ⁽¹⁾	301,0*	304,0 ⁽¹⁾	283,0*	288,0 ⁽¹⁾	258,0*	258,0*										
20	B 346,0	359,0 ⁽¹⁾	314,0	314,0	274,0*	288,0 ⁽¹⁾	251,0*	257,0 ⁽¹⁾	229,0*	229,0*								
22	B 332,0	358,0 ⁽¹⁾	304,0	308,0 ⁽²⁾	283,0	287,0 ⁽¹⁾	260,0	260,0	223,0*	229,0 ⁽¹⁾	205,0*	205,0*						
24	B 319,0	357,0 ⁽¹⁾	293,0	307,0 ⁽²⁾	274,0	285,0 ⁽¹⁾	251,0	256,0 ⁽¹⁾	230,0	230,0	199,0*	205,0 ⁽¹⁾	181,0*	181,0*	166,0*	166,0*		
26	B 305,0	357,0 ⁽¹⁾	280,0	305,0 ⁽²⁾	264,0	284,0 ⁽¹⁾	243,0	254,0 ⁽¹⁾	223,0	227,0 ⁽¹⁾	206,0	206,0	176,0*	183,0 ⁽¹⁾	163,0*	165,0 ⁽¹⁾	147,0*	147,0*
28	B 267,0	343,0 ⁽¹⁾	269,0	303,0 ⁽²⁾	253,0	284,0 ⁽¹⁾	235,0	253,0 ⁽¹⁾	216,0	226,0 ⁽¹⁾	200,0	204,0 ⁽¹⁾	182,0	182,0	159,0*	165,0 ⁽¹⁾	144,0*	147,0 ⁽¹⁾
30	B 328,0 ⁽¹⁾	358,0 ⁽¹⁾	258,0	301,0 ⁽²⁾	244,0	283,0 ⁽¹⁾	226,0	252,0 ⁽¹⁾	209,0	225,0 ⁽¹⁾	194,0	203,0 ⁽¹⁾	178,0	181,0 ⁽¹⁾	164,0	164,0	141,0*	147,0 ⁽¹⁾
32	B 314,0 ⁽¹⁾	355,0 ⁽¹⁾	249,0	291,0 ⁽²⁾	235,0	276,0 ⁽¹⁾	218,0	251,0 ⁽¹⁾	202,0	223,0 ⁽¹⁾	188,0	202,0 ⁽¹⁾	173,0	180,0 ⁽¹⁾	160,0	160,0	143,0*	149,0 ⁽¹⁾
34	B 299,0 ⁽¹⁾	355,0 ⁽¹⁾	217,0	280,0 ⁽²⁾	227,0	267,0 ⁽¹⁾	210,0	246,0 ⁽¹⁾	195,0	223,0 ⁽¹⁾	182,0	202,0 ⁽¹⁾	168,0	180,0 ⁽¹⁾	156,0	156,0	143,0	143,0
36	B 284,0 ⁽¹⁾	356,0 ⁽¹⁾	218,0	280,0 ⁽²⁾	231,0	269,0 ⁽¹⁾	209,0	259,0 ⁽¹⁾	200,0	229,0 ⁽¹⁾	186,0	206,0 ⁽¹⁾	172,0	176,0 ⁽¹⁾	159,0	159,0	145,0	145,0
38	B 270,0 ⁽¹⁾	356,0 ⁽¹⁾	212,0	280,0 ⁽²⁾	222,0	269,0 ⁽¹⁾	207,0	257,0 ⁽¹⁾	193,0	226,0 ⁽¹⁾	181,0	205,0 ⁽¹⁾	167,0	176,0 ⁽¹⁾	155,0	158,0 ⁽¹⁾	142,0	142,0
40	B 255,0 ⁽¹⁾	331,0 ⁽¹⁾	201,0	248,0 ⁽²⁾	201,0	239,0 ⁽¹⁾	190,0	225,0 ⁽¹⁾	176,0	209,0 ⁽¹⁾	165,0	193,0 ⁽¹⁾	154,0	178,0 ⁽¹⁾	145,0	155,0 ⁽¹⁾	133,0	138,0 ⁽¹⁾
44	B 227,0 ⁽¹⁾	303,0 ⁽¹⁾	227,0 ⁽¹⁾	227,0 ⁽¹⁾	221,0 ⁽¹⁾	179,0	210,0 ⁽¹⁾	166,0	197,0 ⁽¹⁾	155,0	185,0 ⁽¹⁾	145,0	171,0 ⁽¹⁾	136,0	155,0 ⁽¹⁾	126,0	138,0 ⁽¹⁾	140,0 ⁽¹⁾
48	B 204,0 ⁽¹⁾	275,0 ⁽¹⁾	205,0 ⁽¹⁾	205,0 ⁽¹⁾	204,0 ⁽¹⁾	196,0 ⁽¹⁾	156,0 ⁽¹⁾	187,0 ⁽¹⁾	147,0	176,0 ⁽¹⁾	147,0	176,0 ⁽¹⁾	136,0	164,0 ⁽¹⁾	128,0	151,0 ⁽¹⁾	120,0	137,0 ⁽¹⁾
52	B 181,0 ⁽¹⁾	248,0 ⁽¹⁾	186,0 ⁽¹⁾	186,0 ⁽¹⁾	186,0 ⁽¹⁾	184,0 ⁽¹⁾	146,0	174,0 ⁽¹⁾	139,0	166,0 ⁽¹⁾	129,0	156,0 ⁽¹⁾	121,0	146,0 ⁽¹⁾	113,0	133,0 ⁽¹⁾	115,0	133,0 ⁽¹⁾
56	B 219,0 ⁽¹⁾	225,0 ⁽¹⁾	167,0 ⁽¹⁾	167,0 ⁽¹⁾	168,0 ⁽¹⁾	169,0 ⁽¹⁾	129,0 ⁽¹⁾	169,0 ⁽¹⁾	132,0	162,0 ⁽¹⁾	132,0	156,0 ⁽¹⁾	123,0	148,0 ⁽¹⁾	115,0	140,0 ⁽¹⁾	107,0	128,0 ⁽¹⁾
60	B 201,0 ⁽¹⁾	225,0 ⁽¹⁾	148,0 ⁽¹⁾	148,0 ⁽¹⁾	152,0 ⁽¹⁾	155,0 ⁽¹⁾	109,0 ⁽¹⁾	155,0 ⁽¹⁾	110,0	153,0 ⁽¹⁾	117,0	147,0 ⁽¹⁾	117,0	140,0 ⁽¹⁾	110,0	132,0 ⁽¹⁾	102,0	124,0 ⁽¹⁾
64	B 183,0 ⁽¹⁾	225,0 ⁽¹⁾	136,0 ⁽¹⁾	136,0 ⁽¹⁾	136,0 ⁽¹⁾	141,0 ⁽¹⁾	107,0	141,0 ⁽¹⁾	110,0	140,0 ⁽¹⁾	107,0	140,0 ⁽¹⁾	107,0	131,0 ⁽¹⁾	104,0	126,0 ⁽¹⁾	97,0	118,0 ⁽¹⁾
68	B 165,0 ⁽¹⁾	225,0 ⁽¹⁾	118,0 ⁽¹⁾	118,0 ⁽¹⁾	118,0 ⁽¹⁾	127,0 ⁽¹⁾	104,0 ⁽¹⁾	129,0 ⁽¹⁾	110,0	129,0 ⁽¹⁾	104,0	130,0 ⁽¹⁾	108,0	125,0 ⁽¹⁾	98,0	120,0 ⁽¹⁾	92,0	112,0 ⁽¹⁾
72	B 149,0 ⁽¹⁾	225,0 ⁽¹⁾	106,0 ⁽¹⁾	106,0 ⁽¹⁾	106,0 ⁽¹⁾	113,0 ⁽¹⁾	104,0 ⁽¹⁾	116,0 ⁽¹⁾	109,0	116,0 ⁽¹⁾	109,0	119,0 ⁽¹⁾	118,0 ⁽¹⁾	118,0 ⁽¹⁾	114,0 ⁽¹⁾	114,0 ⁽¹⁾	87,0	107,0 ⁽¹⁾
76	B 135,0 ⁽¹⁾	225,0 ⁽¹⁾	94,0 ⁽¹⁾	94,0 ⁽¹⁾	94,0 ⁽¹⁾	104,0 ⁽¹⁾	99,0 ⁽¹⁾	104,0 ⁽¹⁾	104,0 ⁽¹⁾	104,0 ⁽¹⁾	104,0 ⁽¹⁾	104,0 ⁽¹⁾	104,0 ⁽¹⁾	104,0 ⁽¹⁾	104,0 ⁽¹⁾	104,0 ⁽¹⁾	78,0	102,0 ⁽¹⁾
80	B 129,0 ⁽¹⁾	225,0 ⁽¹⁾	81,9 ⁽¹⁾	81,9 ⁽¹⁾	81,9 ⁽¹⁾	88,5 ⁽¹⁾	88,5 ⁽¹⁾	88,5 ⁽¹⁾	88,5 ⁽¹⁾	88,5 ⁽¹⁾	88,5 ⁽¹⁾	88,5 ⁽¹⁾	88,5 ⁽¹⁾	88,5 ⁽¹⁾	88,5 ⁽¹⁾	88,5 ⁽¹⁾	79,2	126,0 ⁽¹⁾
88	B 103,0 ⁽¹⁾	225,0 ⁽¹⁾	73,8 ⁽¹⁾	73,8 ⁽¹⁾	73,8 ⁽¹⁾	73,8 ⁽¹⁾	73,8 ⁽¹⁾	73,8 ⁽¹⁾	73,8 ⁽¹⁾	73,8 ⁽¹⁾	73,8 ⁽¹⁾	73,8 ⁽¹⁾	73,8 ⁽¹⁾	73,8 ⁽¹⁾	73,8 ⁽¹⁾	73,8 ⁽¹⁾	73,8 ⁽¹⁾	73,8 ⁽¹⁾
96	B 87,4 ⁽¹⁾	225,0 ⁽¹⁾	56,7 ⁽¹⁾	56,7 ⁽¹⁾	56,7 ⁽¹⁾	56,7 ⁽¹⁾	56,7 ⁽¹⁾	56,7 ⁽¹⁾	56,7 ⁽¹⁾	56,7 ⁽¹⁾	56,7 ⁽¹⁾	56,7 ⁽¹⁾	56,7 ⁽¹⁾	56,7 ⁽¹⁾	56,7 ⁽¹⁾	56,7 ⁽¹⁾	56,7 ⁽¹⁾	56,7 ⁽¹⁾
104	B 79,8 ⁽¹⁾	225,0 ⁽¹⁾	41,0 ⁽¹⁾	41,0 ⁽¹⁾	41,0 ⁽¹⁾	41,0 ⁽¹⁾	41,0 ⁽¹⁾	41,0 ⁽¹⁾	41,0 ⁽¹⁾	41,0 ⁽¹⁾	41,0 ⁽¹⁾	41,0 ⁽¹⁾	41,0 ⁽¹⁾	41,0 ⁽¹⁾	41,0 ⁽¹⁾	41,0 ⁽¹⁾	41,0 ⁽¹⁾	41,0 ⁽¹⁾
112	B 69,1 ⁽¹⁾	225,0 ⁽¹⁾	37,5 ⁽¹⁾	37,5 ⁽¹⁾	37,5 ⁽¹⁾	37,5 ⁽¹⁾	37,5 ⁽¹⁾	37,5 ⁽¹⁾	37,5 ⁽¹⁾	37,5 ⁽¹⁾	37,5 ⁽¹⁾	37,5 ⁽¹⁾	37,5 ⁽¹⁾	37,5 ⁽¹⁾	37,5 ⁽¹⁾	37,5 ⁽¹⁾	37,5 ⁽¹⁾	37,5 ⁽¹⁾
120	B 59,9 ⁽¹⁾	225,0 ⁽¹⁾	30,2 ⁽¹⁾	30,2 ⁽¹⁾	30,2 ⁽¹⁾	30,2 ⁽¹⁾	30,2 ⁽¹⁾	30,2 ⁽¹⁾	30,2 ⁽¹⁾	30,2 ⁽¹⁾	30,2 ⁽¹⁾	30,2 ⁽¹⁾	30,2 ⁽¹⁾	30,2 ⁽¹⁾	30,2 ⁽¹⁾	30,2 ⁽¹⁾	30,2 ⁽¹⁾	30,2 ⁽¹⁾

1) 12° 2) 17° 3) 22° 4) 27° 5) 32° 6) 37° 7) 42° 8) 47° 9) 52° 10) 57° 11) 62°

SDWB/SDWBV/SDWBW

S 84

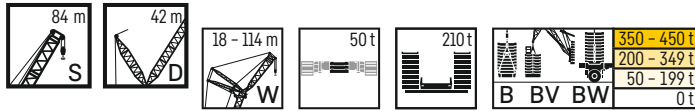

m		S 84 m															
		W 72 m		W 78 m		W 84 m		W 90 m		W 96 m		W 102 m		W 108 m		W 114 m	
		87°/85	WVmax	87°/85	WVmax	87°/85	WVmax	87°/85	WVmax	87°/85	WVmax	87°/85	WVmax	87°/85	WVmax	87°/85	WVmax
28	B	132,0*	132,0*	119,0*	119,0*												
	BV																
	BW	133,0*	133,0*	120,0*	120,0*												
30	B	129,0*	132,0 ⁽¹⁾	117,0*	117,0*	106,0*	106,0*										
	BV																
	BW	130,0*	133,0 ⁽¹⁾	117,0*	117,0*	106,0*	106,0*										
32	B	132,0	132,0	114,0*	118,0 ⁽¹⁾	104,0*	105,0 ⁽¹⁾	93,6*	93,6*								
	BV																
	BW	135,0	135,0	115,0*	119,0 ⁽¹⁾	104,0*	105,0 ⁽¹⁾	93,8*	93,8*								
34	B	131,0	131,0	119,0	119,0	102,0*	105,0 ⁽¹⁾	91,9*	93,2 ⁽¹⁾	83,6*	83,6*	75,0*	75,0*				
	BV																
	BW	133,0	133,0	120,0	120,0	103,0*	106,0 ⁽¹⁾	92,1*	93,6 ⁽¹⁾	83,9*	83,9*	75,0*	75,0*				
36	B	128,0	128,0	116,0	116,0	105,0	105,0	90,1*	93,2 ⁽¹⁾	82,5*	83,6 ⁽¹⁾	73,8*	73,8*	65,4*	65,4*		
	BV																
	BW	130,0	130,0	118,0	118,0	107,0	107,0	90,4*	93,9 ⁽¹⁾	82,8*	84,0 ⁽¹⁾	74,0*	74,0*	65,4*	65,4*	57,0*	57,0*
38	B	126,0	126,0	114,0	114,0	104,0	104,0	93,5	93,5	81,3*	83,6 ⁽¹⁾	72,8*	74,0 ⁽¹⁾	64,4*	64,4*	57,0*	57,0*
	BV																
	BW	127,0	132,0 ⁽¹⁾	115,0	118,0 ⁽¹⁾	105,0	105,0	93,8	93,8								
40	B	123,0	124,0 ⁽²⁾	111,0	111,0	102,0	102,0	91,8	91,8	83,7	83,7	71,5*	74,0 ⁽¹⁾	63,5*	64,8 ⁽¹⁾	56,2*	56,7 ⁽¹⁾
	BV																
	BW	125,0	132,0 ⁽¹⁾	113,0	117,0 ⁽¹⁾	103,0	105,0 ⁽¹⁾	92,6	93,2 ⁽¹⁾	82,7	82,7	73,0	73,0				
44	B	117,0	124,0 ⁽²⁾	107,0	110,0 ⁽²⁾	98,3	98,5 ⁽²⁾	88,6	88,6	81,4	81,4	73,0	73,0	64,6	64,6	56,8	56,8
	BV																
	BW	119,0	131,0 ⁽¹⁾	109,0	116,0 ⁽¹⁾	99,2	104,0 ⁽¹⁾	89,7	92,3 ⁽¹⁾	80,6	81,7 ⁽¹⁾	71,4	71,8 ⁽¹⁾	63,3	63,3	54,9	54,9
48	B	112,0	124,0 ⁽²⁾	103,0	110,0 ⁽²⁾	94,3	98,4 ⁽²⁾	85,4	86,7 ⁽²⁾	78,5	78,5	70,2	70,2	63,0	63,0	55,8	55,8
	BV																
	BW	113,0	129,0 ⁽¹⁾	104,0	111,0 ⁽²⁾	95,5	103,0 ⁽¹⁾	86,6	91,4 ⁽¹⁾	78,1	80,9 ⁽¹⁾	69,4	70,9 ⁽¹⁾	61,9	62,5 ⁽¹⁾	53,7	54,0 ⁽¹⁾
52	B	106,0	124,0 ⁽²⁾	98,0	110,0 ⁽²⁾	89,7	98,5 ⁽²⁾	82,3	86,7 ⁽²⁾	76,0	78,4 ⁽²⁾	67,5	68,2 ⁽²⁾	61,2	61,2	54,3	54,3
	BV																
	BW	107,0	128,0 ⁽¹⁾	99,2	111,0 ⁽²⁾	91,6	99,2 ⁽²⁾	83,4	90,5 ⁽¹⁾	75,4	80,0 ⁽¹⁾	67,3	70,1 ⁽¹⁾	60,1	61,7 ⁽¹⁾	52,4	53,2 ⁽¹⁾
56	B	101,0	119,0 ⁽²⁾	93,4	108,0 ⁽²⁾	85,8	98,6 ⁽²⁾	79,1	86,8 ⁽²⁾	73,3	78,3 ⁽²⁾	65,2	67,9 ⁽²⁾	59,2	60,3 ⁽²⁾	52,7	53,0 ⁽²⁾
	BV																
	BW	101,0	126,0 ⁽¹⁾	94,0	111,0 ⁽²⁾	87,3	98,9 ⁽²⁾	80,0	87,7 ⁽²⁾	72,6	77,5 ⁽²⁾	64,9	69,2 ⁽¹⁾	58,2	60,9 ⁽¹⁾	50,8	52,4 ⁽¹⁾
60	B	95,6	115,0 ⁽²⁾	88,4	106,0 ⁽²⁾	82,1	95,6 ⁽²⁾	75,7	86,2 ⁽²⁾	70,2	78,2 ⁽²⁾	62,9	67,8 ⁽²⁾	57,3	60,1 ⁽²⁾	50,7	52,3 ⁽²⁾
	BV																
	BW	96,6	126,0 ⁽²⁾	88,9	111,0 ⁽²⁾	82,8	98,6 ⁽²⁾	76,3	87,5 ⁽²⁾	69,6	77,2 ⁽²⁾	62,6	67,5 ⁽²⁾	56,2	59,3 ⁽²⁾	49,2	51,6 ⁽¹⁾
64	B	90,4	112,0 ⁽²⁾	83,8	103,0 ⁽²⁾	78,5	93,1 ⁽²⁾	71,7	84,2 ⁽²⁾	66,8	77,1 ⁽²⁾	60,4	67,6 ⁽²⁾	55,3	59,9 ⁽²⁾	48,4	52,1 ⁽²⁾
	BV																
	BW	90,7	126,0 ⁽²⁾	84,0	111,0 ⁽²⁾	78,4	98,3 ⁽²⁾	72,4	87,0 ⁽²⁾	66,5	76,8 ⁽²⁾	60,0	67,1 ⁽²⁾	54,1	59,0 ⁽²⁾	47,4	50,6 ⁽²⁾
68	B	86,4	107,0 ⁽²⁾	80,0	101,0 ⁽²⁾	74,7	90,5 ⁽²⁾	68,2	82,8 ⁽²⁾	63,7	75,7 ⁽²⁾	58,2	66,6 ⁽²⁾	53,1	59,8 ⁽²⁾	46,1	51,9 ⁽²⁾
	BV																
	BW	86,7	123,0 ⁽²⁾	80,3	111,0 ⁽²⁾	75,2	99,3 ⁽²⁾	72,2	87,8 ⁽²⁾	71,8	78,9 ⁽²⁾	64,2	69,0 ⁽²⁾	58,3	61,2 ⁽²⁾	51,3	53,1 ⁽²⁾
72	B	82,8	102,0 ⁽⁴⁾	76,3	95,8 ⁽³⁾	71,0	87,4 ⁽²⁾	64,7	81,3 ⁽²⁾	61,1	74,6 ⁽²⁾	55,7	65,4 ⁽²⁾	51,1	58,7 ⁽²⁾	44,2	51,3 ⁽²⁾
	BV																
	BW	81,6	121,0 ⁽³⁾	75,8	109,0 ⁽³⁾	70,1	97,0 ⁽²⁾	65,0	86,2 ⁽²⁾	59,9	75,6 ⁽²⁾	54,4	65,8 ⁽²⁾	49,6	58,0 ⁽²⁾	43,7	49,9 ⁽²⁾
76	B	78,8	96,9 ⁽⁵⁾	72,6	90,7 ⁽³⁾	67,0	84,3 ⁽³⁾	61,8	78,3 ⁽²⁾	58,3	73,5 ⁽²⁾	53,2	64,3 ⁽²⁾	48,9	57,7 ⁽²⁾	42,5	50,4 ⁽²⁾
	BV																
	BW	77,4	117,0 ⁽⁴⁾	71,8	107,0 ⁽³⁾	67,0	96,6 ⁽³⁾	61,5	85,0 ⁽³⁾	56,7	74,9 ⁽²⁾	51,6	65,0 ⁽²⁾	47,0	57,2 ⁽²⁾	41,6	49,0 ⁽²⁾
80	B	73,7	92,2 ⁽⁵⁾	68,8	85,2 ⁽⁵⁾	64,0	80,8 ⁽⁴⁾	59,0	76,5 ⁽³⁾	55,5	70,3 ⁽²⁾	50,9	63,4 ⁽²⁾	46,1	56,7 ⁽²⁾	40,6	49,5 ⁽²⁾
	BV																
	BW	73,3	114,0 ⁽⁴⁾	68,0	104,0 ⁽⁴⁾	63,5	94,7 ⁽³⁾	58,2	85,5 ⁽³⁾	53,7	73,8 ⁽³⁾	48,8	64,3 ⁽²⁾	44,5	56,5 ⁽²⁾	39,4	48,1 ⁽²⁾
88	B	83,0 ⁽¹⁰⁾	83,0 ⁽¹⁰⁾	58,7	78,0 ⁽⁹⁾	58,9	74,7 ⁽⁵⁾	54,1	69,9 ⁽⁴⁾	50,7	65,1 ⁽⁴⁾	45,4	60,9 ⁽³⁾	41,3	55,1 ⁽³⁾	37,0	47,1 ⁽³⁾
	BV																
	BW	107,0 ⁽⁴⁾	114,0 ⁽⁴⁾	68,3	104,0 ⁽⁴⁾	64,1	95,4 ⁽⁴⁾	59,5	85,9 ⁽³⁾	55,8	75,8 ⁽³⁾	51,3	65,7 ⁽²⁾	46,8	58,5 ⁽²⁾	41,3	50,8 ⁽³⁾
96	B	74,7 ⁽¹¹⁾	74,7 ⁽¹¹⁾	58,9	71,2 ⁽⁹⁾	58,2	67,6 ⁽⁷⁾	48,7	64,0 ⁽⁶⁾	45,2	61,0 ⁽⁵⁾	41,4	56,4 ⁽⁴⁾	37,7	52,4 ⁽⁴⁾	33,7	44,6 ⁽³⁾
	BV																
	BW	99,8 ⁽⁴⁾	100,0 ⁽⁴⁾	68,3	93,2 ⁽⁴⁾	64,1	85,8 ⁽⁴⁾	47,5	77,8 ⁽⁴⁾	43,5	69,1 ⁽⁴⁾	39,5	59,9 ⁽³⁾	35,5	53,2 ⁽³⁾	31,1	44,8 ⁽³⁾
104	B	61,5 ⁽¹¹⁾	61,5 ⁽¹¹⁾	50,8 ⁽¹¹⁾	62,8 ⁽¹¹⁾	53,5 ⁽¹¹⁾	62,1 ⁽¹⁰⁾	48,4	59,0 ⁽⁸⁾	40,4	55,7 ⁽⁷⁾	38,1	52,2 ⁽⁶⁾	34,7	49,4 ⁽⁵⁾	30,6	42,0 ⁽⁴⁾
	BV																
	BW	89,7 ⁽⁶⁾	89,8 ⁽⁷⁾	68,0	86,8 ⁽⁵⁾	64,1	81,3 ⁽⁵⁾	54,1	73,8 ⁽⁵⁾	39,2	66,1 ⁽⁴⁾	35,3	57,8 ⁽⁴⁾	31,8	51,1 ⁽⁴⁾	28,0	43,1 ⁽³⁾
112	B	47,5 ⁽⁹⁾	47,5 ⁽⁹⁾	40,8 ⁽⁹⁾	50,8 ⁽¹¹⁾	41,8 ⁽⁹⁾	53,5 ⁽¹¹⁾	44,4 ⁽¹¹⁾	54,7 ⁽¹¹⁾	40,8	51,4 ⁽⁹⁾	31,7	48,6 ⁽⁹⁾	31,7	44,2 ⁽⁶⁾	28,0	39,5 ⁽⁶⁾
	BV																
	BW	79,6 ⁽⁹⁾	79,7 ⁽⁹⁾	68,0	87,0 ⁽⁹⁾	64,1	76,1 ⁽⁶⁾	54,1	70,5 ⁽⁵⁾	44,4	63,5 ⁽⁵⁾	29,6	55,6 ⁽⁴⁾	28,5	49,3 ⁽⁴⁾	25,0	41,6 ⁽⁴⁾
120	B	35,8 ⁽⁹⁾	35,8 ⁽⁹⁾	30,6 ⁽⁹⁾	37,6 ⁽⁹⁾	31,8 ⁽⁹⁾	41,8 ⁽¹¹⁾	34,4 ⁽¹¹⁾	44,4 ⁽¹¹⁾	30,6	47,3 ⁽¹¹⁾	27,8 ⁽¹¹⁾	43,4 ⁽⁹⁾	30,9	40,8 ⁽⁸⁾	24,0	37,4 ⁽⁷⁾
	BV																
	BW	65,8 ⁽⁹⁾	66,1 ⁽⁹⁾	55,2 ⁽⁹⁾	68,0 ⁽⁹⁾	58,2 ⁽⁹⁾	69,1 ⁽⁸⁾	54,1	66,7 ⁽⁶⁾	44,4	61,0 ⁽⁶⁾	31,7	53,9 ⁽⁵⁾	28,5	47,7 ⁽⁵⁾	22,6	40,3 ⁽⁴⁾
128	B	24,0 ⁽⁷⁾	24,0 ⁽⁷⁾	20,4 ⁽⁷⁾	26,5 ⁽⁹⁾	22,8 ⁽⁷⁾	29,3 ⁽⁹⁾	24,0 ⁽⁷⁾	30,7 ⁽⁹⁾	24,0	36,4 ⁽¹¹⁾	27,8 ⁽¹¹⁾	37,9 ⁽¹¹⁾	30,9	38,1 ⁽¹⁰⁾	24,0	34,0 ⁽⁸⁾
	BV																
	BW	52,5 ⁽⁷⁾	52,8 ⁽⁷⁾	44,4 ⁽⁷⁾	55,2 ⁽⁹⁾	44											

SDWB/SDWBV/SDWBW

S 90

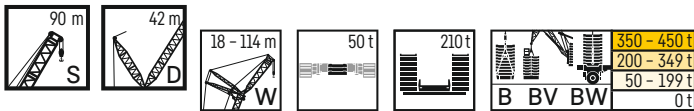

m	S 90 m																	
	W 18 m		W 24 m		W 30 m		W 36 m		W 42 m		W 48 m		W 54 m		W 60 m		W 66 m	
	87°/85	WVmax	87°/85	WVmax	87°/85	WVmax	87°/85	WVmax	87°/85	WVmax	87°/85	WVmax	87°/85	WVmax	87°/85	WVmax	87°/85	WVmax
14	B 321,0*	321,0*																
16	BV 308,0*	319,0 ⁽¹⁾	280,0*	280,0*														
	BW 310,0*	322,0 ⁽¹⁾	282,0*	282,0*														
18	B 317,0	317,0	269,0*	271,0 ⁽¹⁾	253,0*	253,0*												
	BV 319,0	319,0																
20	BW 321,0	321,0	271,0*	277,0 ⁽¹⁾	254,0*	254,0*												
	B 306,0	316,0 ⁽¹⁾	278,0	278,0	245,0*	255,0 ⁽¹⁾	224,0*	227,0 ⁽¹⁾	205,0*	205,0*								
22	BV 307,0	318,0 ⁽¹⁾	280,0	280,0														
	BW 309,0	312,0 ⁽²⁾	282,0	282,0	247,0*	258,0 ⁽¹⁾	225,0*	229,0 ⁽¹⁾	205,0*	205,0*								
24	B 295,0	316,0 ⁽¹⁾	270,0	272,0 ⁽²⁾	253,0	254,0 ⁽¹⁾	217,0*	226,0 ⁽¹⁾	200,0*	203,0 ⁽¹⁾	182,0*	182,0*						
	BV 294,0	316,0 ⁽¹⁾	270,0	279,0 ⁽¹⁾	255,0	255,0 ⁽¹⁾												
26	BW 296,0	310,0 ⁽²⁾	271,0	273,0 ⁽²⁾	256,0	256,0 ⁽¹⁾	219,0*	230,0 ⁽¹⁾	201,0*	205,0 ⁽¹⁾	183,0*	183,0*						
	B 283,0	316,0 ⁽¹⁾	260,0	271,0 ⁽²⁾	244,0	252,0 ⁽¹⁾	224,0	225,0 ⁽¹⁾	194,0*	202,0 ⁽¹⁾	178,0*	181,0 ⁽¹⁾	163,0*	163,0*	148,0*	148,0*		
28	BV 282,0	313,0 ⁽¹⁾	260,0	277,0 ⁽¹⁾	248,0	255,0 ⁽¹⁾	227,0	227,0	206,0	206,0								
	BW 284,0	308,0 ⁽²⁾	261,0	271,0 ⁽²⁾	249,0	256,0 ⁽¹⁾	228,0	229,0 ⁽¹⁾	196,0*	205,0 ⁽¹⁾	179,0*	183,0 ⁽¹⁾	163,0*	163,0*	149,0*	149,0*		
30	B 272,0	315,0 ⁽¹⁾	249,0	271,0 ⁽²⁾	235,0	251,0 ⁽¹⁾	217,0	223,0 ⁽¹⁾	199,0	201,0 ⁽¹⁾	182,0	182,0	158,0*	163,0*	145,0*	146,0 ⁽¹⁾	132,0*	132,0*
	BV 271,0	311,0 ⁽¹⁾	249,0	275,0 ⁽¹⁾	239,0	252,0 ⁽¹⁾	219,0	226,0 ⁽¹⁾	201,0	203,0 ⁽¹⁾	184,0	184,0						
32	BW 273,0	306,0 ⁽²⁾	250,0	269,0 ⁽²⁾	240,0	254,0 ⁽¹⁾	221,0	227,0 ⁽¹⁾	202,0	204,0 ⁽¹⁾	184,0	184,0	159,0*	164,0 ⁽¹⁾	146,0*	147,0 ⁽¹⁾	133,0*	133,0*
	B 264,0	310,0 ⁽¹⁾	238,0	270,0 ⁽²⁾	227,0	250,0 ⁽¹⁾	209,0	223,0 ⁽¹⁾	193,0	199,0 ⁽¹⁾	177,0	180,0 ⁽¹⁾	162,0	162,0	141,0*	146,0 ⁽¹⁾	130,0*	131,0 ⁽¹⁾
34	BV 262,0	310,0 ⁽¹⁾	237,0	272,0 ⁽¹⁾	230,0	250,0 ⁽¹⁾	212,0	224,0 ⁽¹⁾	195,0	201,0 ⁽¹⁾	179,0	181,0 ⁽¹⁾	164,0	164,0				
	BW 264,0	304,0 ⁽²⁾	239,0	267,0 ⁽²⁾	231,0	251,0 ⁽¹⁾	214,0	225,0 ⁽¹⁾	196,0	202,0 ⁽¹⁾	180,0	182,0 ⁽¹⁾	165,0	165,0	143,0*	147,0 ⁽¹⁾	130,0*	132,0 ⁽¹⁾
36	B 300,0 ⁽³⁾	230,0	270,0 ⁽²⁾	218,0	249,0 ⁽¹⁾	201,0	222,0 ⁽¹⁾	187,0	199,0 ⁽¹⁾	173,0	178,0 ⁽¹⁾	158,0	158,0	145,0	145,0	127,0*	130,0 ⁽¹⁾	
	BV 309,0 ⁽¹⁾	229,0	270,0 ⁽²⁾	222,0	248,0 ⁽¹⁾	205,0	222,0 ⁽¹⁾	189,0	199,0 ⁽¹⁾	174,0	179,0 ⁽¹⁾	160,0	162,0 ⁽¹⁾	146,0	146,0			
38	BW 302,0 ⁽²⁾	230,0	264,0 ⁽²⁾	223,0	249,0 ⁽¹⁾	206,0	223,0 ⁽¹⁾	191,0	200,0 ⁽¹⁾	175,0	180,0 ⁽¹⁾	161,0	161,0	147,0	147,0	128,0*	132,0 ⁽¹⁾	
	B 289,0 ⁽⁴⁾	222,0	267,0 ⁽²⁾	211,0	247,0 ⁽¹⁾	195,0	223,0 ⁽¹⁾	180,0	198,0 ⁽¹⁾	168,0	177,0 ⁽¹⁾	154,0	154,0	142,0	142,0	130,0	130,0	
40	BV 308,0 ⁽¹⁾	220,0	270,0 ⁽¹⁾	213,0	246,0 ⁽¹⁾	198,0	220,0 ⁽¹⁾	183,0	197,0 ⁽¹⁾	169,0	178,0 ⁽¹⁾	156,0	160,0 ⁽¹⁾	143,0	145,0 ⁽¹⁾	131,0	131,0	
	BW 301,0 ⁽²⁾	221,0	262,0 ⁽²⁾	215,0	247,0 ⁽¹⁾	199,0	221,0 ⁽¹⁾	184,0	199,0 ⁽¹⁾	170,0	179,0 ⁽¹⁾	157,0	158,0 ⁽¹⁾	144,0	144,0	131,0	131,0	
42	B 278,0 ⁽⁵⁾	215,0	258,0 ⁽²⁾	203,0	242,0 ⁽²⁾	188,0	221,0 ⁽¹⁾	175,0	198,0 ⁽¹⁾	163,0	177,0 ⁽¹⁾	151,0	153,0 ⁽¹⁾	138,0	138,0	128,0	128,0	
	BV 307,0 ⁽¹⁾	211,0	269,0 ⁽¹⁾	205,0	246,0 ⁽¹⁾	191,0	217,0 ⁽¹⁾	178,0	195,0 ⁽¹⁾	164,0	176,0 ⁽¹⁾	152,0	159,0 ⁽¹⁾	140,0	144,0 ⁽¹⁾	128,0	130,0 ⁽¹⁾	
44	BW 301,0 ⁽²⁾	213,0	262,0 ⁽²⁾	207,0	247,0 ⁽¹⁾	192,0	219,0 ⁽¹⁾	178,0	197,0 ⁽¹⁾	165,0	177,0 ⁽¹⁾	153,0	154,0 ⁽¹⁾	140,0	141,0 ⁽¹⁾	129,0	129,0	
	B 267,0 ⁽⁶⁾		250,0 ⁽²⁾	197,0	234,0 ⁽³⁾	181,0	215,0 ⁽¹⁾	169,0	197,0 ⁽¹⁾	157,0	176,0 ⁽¹⁾	147,0	152,0 ⁽¹⁾	135,0	136,0 ⁽²⁾	125,0	125,0	
46	BV 306,0 ⁽¹⁾		268,0 ⁽¹⁾	199,0	245,0 ⁽¹⁾	184,0	217,0 ⁽¹⁾	172,0	194,0 ⁽¹⁾	160,0	175,0 ⁽¹⁾	148,0	158,0 ⁽¹⁾	136,0	142,0	125,0	129,0 ⁽¹⁾	
	BW 300,0 ⁽²⁾		262,0 ⁽²⁾	200,0	246,0 ⁽¹⁾	185,0	218,0 ⁽¹⁾	173,0	195,0 ⁽¹⁾	160,0	176,0 ⁽¹⁾	149,0	153,0 ⁽²⁾	137,0	138,0 ⁽²⁾	126,0	126,0	
48	B 256,0 ⁽¹¹⁾		241,0 ⁽¹⁾	191,0	227,0 ⁽³⁾	175,0	210,0 ⁽²⁾	164,0	192,0 ⁽¹⁾	153,0	176,0 ⁽¹⁾	142,0	152,0 ⁽¹⁾	132,0	136,0 ⁽²⁾	122,0	122,0	
	BV 298,0 ⁽¹⁾		268,0 ⁽¹⁾	192,0	245,0 ⁽¹⁾	177,0	217,0 ⁽¹⁾	166,0	193,0 ⁽¹⁾	155,0	173,0 ⁽¹⁾	143,0	156,0 ⁽¹⁾	133,0	141,0 ⁽¹⁾	122,0	128,0 ⁽¹⁾	
50	BW 288,0 ⁽⁴⁾		261,0 ⁽²⁾	194,0	246,0 ⁽¹⁾	178,0	218,0 ⁽¹⁾	167,0	191,0 ⁽¹⁾	156,0	174,0 ⁽¹⁾	145,0	152,0 ⁽²⁾	133,0	137,0 ⁽²⁾	123,0	124,0 ⁽¹⁾	
	B 245,0 ⁽¹¹⁾		233,0 ⁽²⁾	186,0	220,0 ⁽⁵⁾	170,0	204,0 ⁽⁵⁾	158,0	189,0 ⁽²⁾	148,0	172,0 ⁽¹⁾	138,0	152,0 ⁽²⁾	128,0	136,0 ⁽²⁾	119,0	122,0 ⁽²⁾	
52	BV 288,0 ⁽¹⁾		264,0 ⁽¹⁾	186,0	245,0 ⁽¹⁾	172,0	217,0 ⁽¹⁾	160,0	193,0 ⁽¹⁾	150,0	172,0 ⁽¹⁾	139,0	155,0 ⁽¹⁾	129,0	140,0 ⁽¹⁾	119,0	127,0 ⁽¹⁾	
	BW 277,0 ⁽⁶⁾		261,0 ⁽²⁾	188,0	245,0 ⁽¹⁾	173,0	218,0 ⁽¹⁾	161,0	188,0 ⁽¹⁾	151,0	171,0 ⁽¹⁾	140,0	151,0 ⁽²⁾	130,0	136,0 ⁽²⁾	120,0	123,0 ⁽²⁾	
54	B 271,0 ⁽⁹⁾		216,0 ⁽⁹⁾	199,0	205,0 ⁽⁶⁾	160,0	194,0 ⁽¹⁾	148,0	179,0 ⁽²⁾	138,0	166,0 ⁽²⁾	130,0	152,0 ⁽²⁾	121,0	136,0 ⁽²⁾	113,0	122,0 ⁽²⁾	
	BV 251,0 ⁽¹⁾		251,0 ⁽¹⁾	199,0	239,0 ⁽²⁾	160,0	217,0 ⁽¹⁾	149,0	192,0 ⁽¹⁾	140,0	172,0 ⁽¹⁾	131,0	154,0 ⁽¹⁾	122,0	138,0 ⁽¹⁾	114,0	124,0 ⁽¹⁾	
56	BW 249,0 ⁽²⁾		249,0 ⁽²⁾	200,0	239,0 ⁽²⁾	162,0	217,0 ⁽¹⁾	150,0	187,0 ⁽²⁾	141,0	167,0 ⁽²⁾	132,0	149,0 ⁽²⁾	123,0	135,0 ⁽²⁾	114,0	122,0 ⁽²⁾	
	B 200,0 ⁽¹⁰⁾		200,0 ⁽¹⁰⁾	193,0 ⁽¹¹⁾	193,0 ⁽¹¹⁾	182,0 ⁽²⁾	217,0 ⁽¹⁾	141,0	170,0 ⁽²⁾	131,0	159,0 ⁽²⁾	123,0	147,0 ⁽²⁾	114,0	135,0 ⁽²⁾	107,0	122,0 ⁽²⁾	
58	BV 252,0 ⁽⁹⁾		237,0 ⁽¹⁾	191,0	227,0 ⁽⁴⁾	175,0	209,0 ⁽²⁾	141,0	190,0 ⁽¹⁾	131,0	171,0 ⁽¹⁾	123,0	153,0 ⁽¹⁾	115,0	137,0 ⁽¹⁾	108,0	123,0 ⁽¹⁾	
	BW 236,0 ⁽²⁾		236,0 ⁽²⁾	192,0	227,0 ⁽⁴⁾	178,0	209,0 ⁽²⁾	142,0	188,0 ⁽²⁾	132,0	167,0 ⁽²⁾	124,0	149,0 ⁽²⁾	116,0	133,0 ⁽²⁾	109,0	120,0 ⁽²⁾	
60	B 183,0 ⁽¹⁰⁾		183,0 ⁽¹⁰⁾	179,0 ⁽¹¹⁾	179,0 ⁽¹¹⁾	170,0 ⁽⁹⁾	200,0 ⁽¹⁾	133,0	185,0 ⁽²⁾	124,0	153,0 ⁽²⁾	116,0	140,0 ⁽²⁾	108,0	131,0 ⁽²⁾	101,0	120,0 ⁽²⁾	
	BV 234,0 ⁽⁹⁾		224,0 ⁽¹⁾	191,0	215,0 ⁽⁶⁾	172,0	200,0 ⁽¹⁾	133,0	185,0 ⁽²⁾	123,0	167,0 ⁽²⁾	115,0	152,0 ⁽¹⁾	108,0	137,0 ⁽¹⁾	102,0	122,0 ⁽¹⁾	
62	BW 223,0 ⁽²⁾		223,0 ⁽²⁾	200,0 ⁽¹⁾	215,0 ⁽⁶⁾	173,0	200,0 ⁽¹⁾	134,0	185,0 ⁽²⁾	125,0	167,0 ⁽²⁾	116,0	149,0 ⁽²⁾	109,0	133,0 ⁽²⁾	103,0	119,0 ⁽²⁾	
	B 165,0 ⁽¹⁰⁾		165,0 ⁽¹⁰⁾	160,0 ⁽¹¹⁾	165,0 ⁽¹⁰⁾	160,0 ⁽¹¹⁾	152,0 ⁽⁹⁾	118,0	152,0 ⁽⁹⁾	118,0	145,0 ⁽⁵⁾	109,0	134,0 ⁽²⁾	103,0	126,0 ⁽²⁾	96,3	117,0 ⁽²⁾	
64	BV 210,0 ⁽¹⁾		206,0 ⁽¹⁰⁾	199,0	206,0 ⁽¹⁰⁾	191,0	178,0 ⁽²⁾	116,0	178,0 ⁽²⁾	116,0	164,0 ⁽²⁾	109,0	149,0 ⁽²⁾	102,0	133,0 ⁽²⁾	95,8	116,0 ⁽²⁾	
	BW 209,0 ⁽²⁾		209,0 ⁽²⁾	206,0 ⁽¹⁰⁾	206,0 ⁽¹⁰⁾	191,0	178,0 ⁽²⁾	118,0	178,0 ⁽²⁾	118,0	164,0 ⁽²⁾	110,0	149,0 ⁽²⁾	103,0	133,0 ⁽²⁾	96,9	119,0 ⁽²⁾	
66	B 148,0 ⁽¹⁰⁾		148,0 ⁽¹⁰⁾	149,0 ⁽¹⁰⁾	149,0 ⁽¹⁰⁾	150,0 ⁽¹⁰⁾	145,0 ⁽¹¹⁾	105,0										

SDWB/SDWBV/SDWBW

S 90

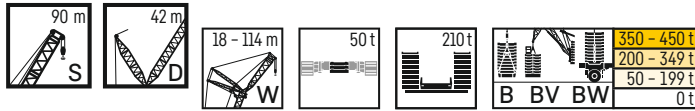

m	B BV BW	S 90 m																
		W 72 m		W 78 m		W 84 m		W 90 m		W 96 m		W 102 m		W 108 m		W 114 m		
		87°/85	WVmax	87°/85	WVmax	87°/85	WVmax	87°/85	WVmax	87°/85	WVmax	87°/85	WVmax	87°/85	WVmax	87°/85	WVmax	
28	B	118,0*	118,0*															
	BV																	
	BW																	
30	B	118,0*	118,0*	104,0*	104,0*	94,4*	94,4*											
	BV																	
	BW																	
32	B	112,0*	116,0 ⁽¹⁾	102,0*	104,0 ⁽¹⁾	92,3*	92,3*	84,2*	84,2*									
	BV																	
	BW																	
34	B	116,0	116,0	100,0*	103,0 ⁽¹⁾	90,5*	92,5 ⁽¹⁾	82,9*	83,5 ⁽¹⁾	75,0*	75,0*	64,8*	64,8*					
	BV																	
	BW																	
36	B	113,0	113,0	103,0	103,0	92,8	92,8	81,6*	83,2 ⁽¹⁾	73,7*	74,6 ⁽¹⁾	64,9*	64,9*	58,2*	58,2*			
	BV																	
	BW																	
38	B	111,0	111,0	101,0	101,0	91,0	91,0	83,4	83,4	72,3*	74,3 ⁽¹⁾	63,8*	64,7 ⁽¹⁾	57,4*	57,4*	50,6*	50,6*	
	BV																	
	BW																	
40	B	108,0	109,0 ⁽²⁾	98,9	98,9	89,3	89,3	82,0	82,0	74,3	74,3	62,8*	64,5 ⁽¹⁾	56,6*	57,4 ⁽¹⁾	49,9*	50,2 ⁽¹⁾	
	BV																	
	BW																	
44	B	104,0	108,0 ⁽²⁾	94,3	96,3 ⁽²⁾	86,1	86,1	79,3	79,3	71,7	71,7	63,5	63,5	57,1	57,1	49,8*	50,0 ⁽¹⁾	
	BV																	
	BW																	
48	B	99,2	108,0 ⁽²⁾	90,1	96,3 ⁽²⁾	82,5	85,3 ⁽²⁾	76,6	77,4 ⁽²⁾	68,5	68,5	61,3	61,3	55,4	55,4	49,0	49,0	
	BV																	
	BW																	
52	B	94,1	109,0 ⁽²⁾	86,1	96,4 ⁽²⁾	79,2	85,4 ⁽²⁾	73,1	77,3 ⁽²⁾	65,9	67,6 ⁽²⁾	59,4	59,7 ⁽²⁾	53,7	53,7	46,6	46,6	
	BV																	
	BW																	
56	B	88,9	106,0 ⁽²⁾	81,8	96,3 ⁽²⁾	75,8	85,4 ⁽²⁾	69,6	77,3 ⁽²⁾	63,3	67,6 ⁽²⁾	57,2	59,4 ⁽²⁾	52,0	52,7 ⁽²⁾	44,3	44,5 ⁽²⁾	
	BV																	
	BW																	
60	B	84,2	104,0 ⁽²⁾	77,9	93,3 ⁽²⁾	72,0	84,7 ⁽²⁾	66,5	77,3 ⁽²⁾	60,8	67,6 ⁽²⁾	55,1	59,4 ⁽²⁾	49,5	52,5 ⁽²⁾	42,9	43,9 ⁽²⁾	
	BV																	
	BW																	
64	B	80,2	102,0 ⁽²⁾	74,1	91,0 ⁽²⁾	68,1	83,1 ⁽²⁾	63,5	76,0 ⁽²⁾	58,4	67,6 ⁽²⁾	53,0	59,3 ⁽²⁾	46,9	52,4 ⁽²⁾	41,2	43,8 ⁽²⁾	
	BV																	
	BW																	
68	B	76,6	97,0 ⁽²⁾	70,5	88,7 ⁽²⁾	64,7	81,8 ⁽²⁾	60,7	74,2 ⁽²⁾	55,8	66,3 ⁽²⁾	50,7	59,0 ⁽²⁾	44,7	52,4 ⁽²⁾	39,5	43,7 ⁽²⁾	
	BV																	
	BW																	
72	B	72,7	94,1 ⁽³⁾	66,8	85,1 ⁽³⁾	61,7	80,5 ⁽³⁾	58,0	73,2 ⁽³⁾	53,4	65,6 ⁽³⁾	47,7	58,2 ⁽³⁾	42,8	52,0 ⁽³⁾	37,9	43,6 ⁽³⁾	
	BV																	
	BW																	
76	B	68,9	87,8 ⁽³⁾	63,6	82,0 ⁽³⁾	59,1	77,1 ⁽³⁾	55,3	72,3 ⁽³⁾	51,0	64,9 ⁽³⁾	45,0	57,6 ⁽³⁾	41,1	51,4 ⁽³⁾	36,4	43,1 ⁽³⁾	
	BV																	
	BW																	
80	B	65,9	83,3 ⁽³⁾	60,6	79,0 ⁽⁴⁾	56,4	74,3 ⁽³⁾	53,1	68,7 ⁽³⁾	48,5	63,4 ⁽³⁾	42,9	57,1 ⁽³⁾	39,2	50,7 ⁽³⁾	34,6	42,6 ⁽³⁾	
	BV																	
	BW																	
88	B	76,5 ⁽¹⁾	97,1 ⁽³⁾	54,3	72,6 ⁽⁴⁾	51,8	67,7 ⁽³⁾	47,5	64,1 ⁽⁴⁾	43,0	58,9 ⁽³⁾	38,9	54,8 ⁽³⁾	35,6	48,9 ⁽³⁾	31,4	41,6 ⁽²⁾	
	BV																	
	BW																	
96	B	70,0 ⁽¹⁰⁾	93,8 ⁽³⁾	48,2 ⁽³⁾	65,6 ⁽⁸⁾	42,8	62,1 ⁽¹⁾	42,8	58,5 ⁽⁶⁾	39,2	55,2 ⁽⁶⁾	35,3	46,1 ⁽⁵⁾	32,2	46,1 ⁽⁵⁾	28,3	40,3 ⁽⁵⁾	
	BV																	
	BW																	
104	B	58,5 ⁽¹¹⁾	85,6 ⁽⁵⁾	35,5 ⁽⁹⁾	59,9 ⁽¹¹⁾	26,9 ⁽⁹⁾	57,9 ⁽⁹⁾	54,0 ⁽⁷⁾	66,0 ⁽⁵⁾	36,1	51,2 ⁽⁶⁾	32,4	47,2 ⁽⁵⁾	29,1	42,2 ⁽⁵⁾	25,5	38,6 ⁽⁴⁾	
	BV																	
	BW																	
112	B	46,6 ⁽¹¹⁾	77,6 ⁽⁹⁾	21,1 ⁽⁷⁾	48,2 ⁽¹¹⁾	16,9 ⁽⁹⁾	51,1 ⁽¹¹⁾	42,2 ⁽¹¹⁾	66,0 ⁽⁵⁾	26,5	47,0 ⁽⁸⁾	28,5	42,6 ⁽⁷⁾	26,4	39,9 ⁽⁶⁾	21,8	36,0 ⁽⁵⁾	
	BV																	
	BW																	
120	B	33,5 ⁽⁹⁾	64,4 ⁽⁹⁾	12,0 ⁽⁷⁾	35,0 ⁽⁹⁾	6,4 ⁽⁹⁾	26,9 ⁽⁹⁾	22,9 ⁽⁹⁾	57,1 ⁽⁸⁾	19,7 ⁽⁹⁾	23,7 ⁽¹¹⁾	25,8 ⁽¹¹⁾	39,4 ⁽⁹⁾	36,0 ⁽⁷⁾	36,0 ⁽⁷⁾	19,8	32,5 ⁽⁷⁾	
	BV																	
	BW																	
128	B	21,1 ⁽⁷⁾	50,7 ⁽⁷⁾	5,1 ⁽⁷⁾	24,3 ⁽⁹⁾	2,3 ⁽⁹⁾	11,1 ⁽⁷⁾	10,2 ⁽⁹⁾	57,1 ⁽⁸⁾	10,2 ⁽⁹⁾	10,5 ⁽⁷⁾	10,5 ⁽⁷⁾	35,7 ⁽¹¹⁾	33,6 ⁽¹⁰⁾	33,6 ⁽¹⁰⁾	11,2 ⁽¹¹⁾	31,3 ⁽⁸⁾	
	BV																	
	BW																	
136	B	12,0 ⁽⁷⁾	40,0 ⁽⁷⁾	4,0 ⁽⁵⁾	16,9 ⁽⁹⁾	1,6 ⁽⁹⁾	7,9 ⁽⁹⁾	7,9 ⁽⁹⁾	57,1 ⁽⁸⁾	19,7 ⁽⁹⁾	23,7 ⁽¹¹⁾	25,8 ⁽¹¹⁾	39,4 ⁽⁹⁾	36,0 ⁽⁷⁾	36,0 ⁽⁷⁾	19,8	32,5 ⁽⁷⁾	
	BV																	
	BW																	
144	B																	
	BV																	
	BW																	
152	B																	
	BV																	
	BW																	
160	B																	
	BV																	
	BW																	
168	B																	
	BV																	
	BW																	
176	B																	
	BV																	
	BW																	

1) 12° 2) 17° 3) 22° 4) 27° 5) 32° 6) 37° 7) 42° 8) 47° 9) 52° 10) 57° 11) 62°

SDWB/SDWBV/SDWBW

S 96

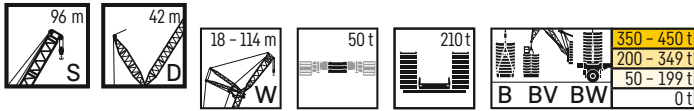

m	S 96 m																	
	W 18 m		W 24 m		W 30 m		W 36 m		W 42 m		W 48 m		W 54 m		W 60 m		W 66 m	
	87°/85	WVmax	87°/85	WVmax	87°/85	WVmax	87°/85	WVmax	87°/85	WVmax	87°/85	WVmax	87°/85	WVmax	87°/85	WVmax	87°/85	WVmax
16	B 275,0*	BV 282,0 ⁽¹⁾	B 251,0*	BV 251,0*														
18	B 264,0*	BV 281,0 ⁽¹⁾	B 241,0*	BV 243,0 ⁽¹⁾	226,0*	226,0*												
20	B 274,0	BV 280,0 ⁽¹⁾	B 241,0	BV 241,0	220,0*	226,0 ⁽¹⁾	200,0*	200,0*	182,0*	182,0*								
22	B 264,0	BV 279,0 ⁽¹⁾	B 242,0	BV 242,0	225,0	225,0	194,0*	200,0 ⁽¹⁾	178,0*	180,0 ⁽¹⁾	163,0*	163,0*						
24	B 254,0	BV 278,0 ⁽¹⁾	B 232,0	BV 241,0 ⁽²⁾	218,0	223,0 ⁽¹⁾	199,0	199,0	172,0*	178,0 ⁽¹⁾	158,0*	161,0 ⁽¹⁾	144,0*	144,0*				
26	B 243,0	BV 270,0 ⁽¹⁾	B 223,0	BV 240,0 ⁽²⁾	211,0	222,0 ⁽¹⁾	193,0	198,0 ⁽¹⁾	177,0	178,0 ⁽¹⁾	153,0*	159,0 ⁽¹⁾	140,0*	143,0 ⁽¹⁾	129,0*	129,0*	118,0*	118,0*
28	B 237,0	BV 277,0 ⁽¹⁾	B 215,0	BV 239,0 ⁽²⁾	204,0	221,0 ⁽¹⁾	187,0	198,0 ⁽¹⁾	172,0	177,0 ⁽¹⁾	155,0*	161,0 ⁽¹⁾	141,0*	145,0 ⁽¹⁾	130,0*	130,0*	118,0*	118,0*
30	B 261,0 ⁽²⁾	BV 270,0 ⁽²⁾	B 207,0	BV 238,0 ⁽²⁾	196,0	220,0 ⁽¹⁾	181,0	197,0 ⁽¹⁾	167,0	176,0 ⁽¹⁾	153,0	158,0 ⁽¹⁾	140,0	140,0	129,0	129,0	112,0*	115,0 ⁽¹⁾
32	B 266,0 ⁽¹⁾	BV 261,0 ⁽²⁾	B 199,0	BV 233,0 ⁽¹⁾	191,0	213,0 ⁽¹⁾	176,0	192,0 ⁽¹⁾	163,0	173,0 ⁽¹⁾	150,0	156,0 ⁽¹⁾	137,0	140,0 ⁽¹⁾	127,0	128,0 ⁽¹⁾	115,0	115,0
34	B 254,0 ⁽¹⁾	BV 266,0 ⁽¹⁾	B 194,0	BV 232,0 ⁽¹⁾	183,0	216,0 ⁽¹⁾	169,0	195,0 ⁽¹⁾	157,0	175,0 ⁽¹⁾	145,0	157,0 ⁽¹⁾	133,0	139,0 ⁽¹⁾	124,0	124,0	112,0	112,0
36	B 246,0 ⁽¹⁾	BV 266,0 ⁽¹⁾	B 188,0	BV 226,0 ⁽²⁾	177,0	211,0 ⁽¹⁾	164,0	192,0 ⁽¹⁾	152,0	174,0 ⁽¹⁾	141,0	156,0 ⁽¹⁾	129,0	139,0 ⁽¹⁾	120,0	121,0 ⁽¹⁾	110,0	110,0
38	B 239,0 ⁽¹⁾	BV 266,0 ⁽¹⁾	B 172,0	BV 219,0 ⁽¹⁾	160,0	206,0 ⁽¹⁾	159,0	188,0 ⁽¹⁾	147,0	172,0 ⁽¹⁾	137,0	156,0 ⁽¹⁾	126,0	138,0 ⁽¹⁾	117,0	121,0 ⁽²⁾	107,0	107,0
40	B 230,0 ⁽¹⁾	BV 261,0 ⁽²⁾	B 167,0	BV 213,0 ⁽¹⁾	154,0	201,0 ⁽¹⁾	154,0	184,0 ⁽¹⁾	143,0	169,0 ⁽¹⁾	133,0	154,0 ⁽¹⁾	123,0	138,0 ⁽¹⁾	114,0	121,0 ⁽²⁾	105,0	107,0 ⁽²⁾
44	B 213,0 ⁽¹⁾	BV 246,0 ⁽¹⁾	B 146,0	BV 200,0 ⁽³⁾	134,0	190,0 ⁽¹⁾	145,0	176,0 ⁽¹⁾	134,0	163,0 ⁽¹⁾	125,0	149,0 ⁽²⁾	115,0	133,0 ⁽¹⁾	108,0	121,0 ⁽¹⁾	99,7	107,0 ⁽²⁾
48	B 234,0 ⁽¹⁾	BV 214,0 ⁽²⁾	B 118,0	BV 188,0 ⁽⁵⁾	118,0	177,0 ⁽²⁾	127,0	167,0 ⁽¹⁾	127,0	157,0 ⁽¹⁾	118,0	143,0 ⁽²⁾	109,0	131,0 ⁽¹⁾	103,0	121,0 ⁽²⁾	94,1	107,0 ⁽²⁾
52	B 221,0 ⁽¹⁾	BV 206,0 ⁽²⁾	B 103,0	BV 173,0 ⁽⁷⁾	103,0	167,0 ⁽¹⁾	122,0	157,0 ⁽¹⁾	122,0	150,0 ⁽²⁾	112,0	138,0 ⁽²⁾	103,0	127,0 ⁽²⁾	97,5	118,0 ⁽²⁾	89,2	107,0 ⁽²⁾
56	B 208,0 ⁽¹⁾	BV 197,0 ⁽²⁾	B 88,0	BV 158,0 ⁽¹⁰⁾	88,0	157,0 ⁽¹¹⁾	119,0	149,0 ⁽⁶⁾	119,0	141,0 ⁽⁵⁾	106,0	131,0 ⁽²⁾	98,3	123,0 ⁽²⁾	91,8	114,0 ⁽²⁾	84,9	104,0 ⁽²⁾
60	B 193,0 ⁽⁵⁾	BV 189,0 ⁽²⁾	B 77,0	BV 144,0 ⁽¹⁰⁾	77,0	144,0 ⁽¹⁰⁾	110,0	140,0 ⁽⁸⁾	110,0	132,0 ⁽¹⁰⁾	105,0	125,0 ⁽⁴⁾	93,1	118,0 ⁽²⁾	87,6	111,0 ⁽²⁾	80,7	102,0 ⁽²⁾
64	B 178,0 ⁽⁷⁾	BV 177,0 ⁽⁴⁾	B 66,0	BV 129,0 ⁽¹⁰⁾	66,0	131,0 ⁽¹⁰⁾	109,0	130,0 ⁽⁹⁾	109,0	125,0 ⁽¹¹⁾	102,0	119,0 ⁽⁵⁾	89,8	112,0 ⁽⁴⁾	83,4	106,0 ⁽⁵⁾	77,3	100,0 ⁽²⁾
68	B 163,0 ⁽⁷⁾	BV 160,0 ⁽⁵⁾	B 55,0	BV 118,0 ⁽¹⁰⁾	55,0	118,0 ⁽¹⁰⁾	100,0	119,0 ⁽⁹⁾	100,0	113,0 ⁽⁷⁾	100,0	113,0 ⁽⁷⁾	87,8	107,0 ⁽⁵⁾	80,0	102,0 ⁽⁴⁾	73,8	95,6 ⁽⁵⁾
72	B 148,0 ⁽⁷⁾	BV 150,0 ⁽⁷⁾	B 44,0	BV 105,0 ⁽¹⁰⁾	44,0	105,0 ⁽¹⁰⁾	90,0	108,0 ⁽⁹⁾	90,0	109,0 ⁽¹⁰⁾	90,0	108,0 ⁽¹¹⁾	84,8	102,0 ⁽⁶⁾	77,8	102,0 ⁽⁵⁾	71,8	99,2 ⁽⁵⁾
76	B 132,0 ⁽⁵⁾	BV 93,1 ⁽⁸⁾	B 33,0	BV 93,1 ⁽¹⁰⁾	33,0	96,7 ⁽¹⁰⁾	80,0	139,0 ⁽⁶⁾	80,0	137,0 ⁽³⁾	80,0	132,0 ⁽²⁾	81,8	120,0 ⁽²⁾	78,2	109,0 ⁽²⁾	65,0	97,1 ⁽²⁾
80	B 121,0 ⁽³⁾	BV 127,0 ⁽⁸⁾	B 22,0	BV 83,4 ⁽⁸⁾	22,0	83,4 ⁽⁸⁾	66,0	139,0 ⁽⁶⁾	66,0	130,0 ⁽⁸⁾	66,0	126,0 ⁽³⁾	82,5 ⁽¹¹⁾	118,0 ⁽²⁾	86,2 ⁽¹¹⁾	108,0 ⁽²⁾	61,1 ⁽⁶⁾	96,1 ⁽²⁾
88	B 95,7 ⁽⁵⁾	BV 109,0 ⁽⁸⁾	B 13,0	BV 61,1 ⁽⁶⁾	13,0	61,1 ⁽⁶⁾	48,0	109,0 ⁽⁸⁾	48,0	112,0 ⁽⁸⁾	48,0	113,0 ⁽⁶⁾	81,0 ⁽⁴⁾	110,0 ⁽⁴⁾	80,0 ⁽³⁾	105,0 ⁽³⁾	50,0 ⁽²⁾	94,4 ⁽²⁾
96	B 84,8 ⁽⁶⁾	BV 93,1 ⁽⁸⁾	B 10,0	BV 56,0 ⁽⁸⁾	10,0	56,0 ⁽⁸⁾	33,0	139,0 ⁽⁶⁾	33,0	130,0 ⁽⁸⁾	33,0	126,0 ⁽³⁾	82,5 ⁽¹¹⁾	118,0 ⁽²⁾	86,2 ⁽¹¹⁾	108,0 ⁽²⁾	41,1 ⁽⁹⁾	91,0 ⁽⁴⁾
104	B 72,5 ⁽⁴⁾	BV 75,5 ⁽⁶⁾	B 7,0	BV 41,0 ⁽⁶⁾	7,0	41,0 ⁽⁶⁾	29,0	139,0 ⁽⁶⁾	29,0	130,0 ⁽⁸⁾	29,0	126,0 ⁽³⁾	82,5 ⁽¹¹⁾	118,0 ⁽²⁾	86,2 ⁽¹¹⁾	108,0 ⁽²⁾	33,3 ⁽⁷⁾	88,7 ⁽⁶⁾
112	B 64,3 ⁽⁶⁾	BV 61,1 ⁽⁶⁾	B 5,0	BV 29,0 ⁽⁶⁾	5,0	29,0 ⁽⁶⁾	22,0	109,0 ⁽⁸⁾	22,0	112,0 ⁽⁸⁾	22,0	113,0 ⁽⁶⁾	81,0 ⁽⁴⁾	110,0 ⁽⁴⁾	80,0 ⁽³⁾	105,0 ⁽³⁾	26,2 ⁽⁷⁾	74,3 ⁽⁹⁾
120	B 54,2 ⁽²⁾	BV 53,8 ⁽⁷⁾	B 4,0	BV 22,8 ⁽⁷⁾	4,0	22,8 ⁽⁷⁾	16,0	109,0 ⁽⁸⁾	16,0	112,0 ⁽⁸⁾	16,0	113,0 ⁽⁶⁾	81,0 ⁽⁴⁾	110,0 ⁽⁴⁾	80,0 ⁽³⁾	105,0 ⁽³⁾	26,2 ⁽⁷⁾	74,3 ⁽⁹⁾
128	B 46,4 ⁽⁷⁾	BV 45,8 ⁽⁷⁾	B 3,0	BV 16,3 ⁽⁷⁾	3,0	16,3 ⁽⁷⁾	11,0	109,0 ⁽⁸⁾	11,0	112,0 ⁽⁸⁾	11,0	113,0 ⁽⁶⁾	81,0 ⁽⁴⁾	110,0 ⁽⁴⁾	80,0 ⁽³⁾	105,0 ⁽³⁾	26,2 ⁽⁷⁾	74,3 ⁽⁹⁾
136	B 37,3 ⁽⁷⁾	BV 36,8 ⁽⁷⁾	B 2,0	BV 11,6 ⁽⁷⁾	2,0	11,6 ⁽⁷⁾	7,0	109,0 ⁽⁸⁾	7,0	112,0 ⁽⁸⁾	7,0	113,0 ⁽⁶⁾	81,0 ⁽⁴⁾	110,0 ⁽⁴⁾	80,0 ⁽³⁾	105,0 ⁽³⁾	26,2 ⁽⁷⁾	74,3 ⁽⁹⁾

1) 12° 2) 17° 3) 22° 4) 27° 5) 32° 6) 37° 7) 42° 8) 47° 9) 52° 10) 57° 11) 62°

SDWB/SDWBV/SDWBW

S 102

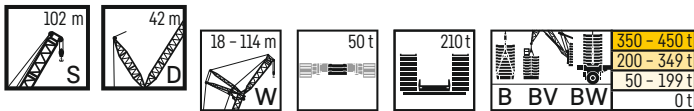

m	S 102 m																		
	W 18 m		W 24 m		W 30 m		W 36 m		W 42 m		W 48 m		W 54 m		W 60 m		W 66 m		
	87°/85	WVmax	87°/85	WVmax	87°/85	WVmax	87°/85	WVmax	87°/85	WVmax	87°/85	WVmax	87°/85	WVmax	87°/85	WVmax	87°/85	WVmax	
16	B	245,0*	249,0 ⁽¹⁾	223,0*	223,0*														
	BV	246,0*	251,0 ⁽¹⁾	223,0*	223,0*														
	BW	236,0*	247,0 ⁽¹⁾	215,0*	220,0 ⁽¹⁾	200,0*	200,0*												
18	B	237,0*	249,0 ⁽¹⁾	216,0*	221,0 ⁽¹⁾	201,0*	201,0*												
	BV	244,0	247,0 ⁽¹⁾	207,0*	218,0 ⁽¹⁾	194,0*	198,0 ⁽¹⁾	178,0*	178,0*										
	BW	244,0	247,0 ⁽¹⁾	208,0*	220,0 ⁽¹⁾	196,0*	200,0 ⁽¹⁾	178,0*	178,0*										
20	B	236,0	246,0 ⁽¹⁾	215,0	215,0	198,0	198,0	172,0*	176,0 ⁽¹⁾	157,0*	158,0 ⁽¹⁾	144,0*	144,0*						
	BV	234,0	242,0 ⁽¹⁾	213,0	216,0 ⁽¹⁾	199,0	199,0												
	BW	235,0	244,0 ⁽¹⁾	214,0	216,0 ⁽¹⁾	200,0	200,0	173,0*	178,0 ⁽¹⁾	158,0*	160,0 ⁽¹⁾	145,0*	145,0*						
22	B	226,0	245,0 ⁽¹⁾	207,0	212,0 ⁽²⁾	192,0	196,0 ⁽¹⁾	175,0	175,0	152,0*	157,0 ⁽¹⁾	139,0*	141,0 ⁽¹⁾	128,0*	128,0*				
	BV	224,0	238,0 ⁽¹⁾	205,0	213,0 ⁽¹⁾	193,0	196,0 ⁽¹⁾	176,0	176,0										
	BW	225,0	241,0 ⁽¹⁾	206,0	210,0 ⁽²⁾	194,0	197,0 ⁽¹⁾	177,0	177,0	153,0*	158,0 ⁽¹⁾	141,0*	143,0 ⁽¹⁾	129,0*	129,0*				
24	B	217,0	244,0 ⁽¹⁾	199,0	211,0 ⁽²⁾	186,0	195,0 ⁽¹⁾	171,0	174,0 ⁽¹⁾	155,0	155,0	135,0*	140,0 ⁽¹⁾	125,0*	127,0 ⁽¹⁾	114,0*	114,0*	104,0*	104,0*
	BV	214,0	234,0 ⁽¹⁾	196,0	209,0 ⁽¹⁾	187,0	193,0 ⁽¹⁾	171,0	174,0 ⁽¹⁾	156,0	156,0								
	BW	216,0	238,0 ⁽¹⁾	197,0	207,0 ⁽²⁾	188,0	194,0 ⁽¹⁾	172,0	174,0 ⁽¹⁾	157,0	157,0	136,0*	142,0 ⁽¹⁾	125,0*	128,0 ⁽¹⁾	115,0*	115,0*	104,0*	104,0*
26	B	211,0	244,0 ⁽¹⁾	191,0	211,0 ⁽²⁾	180,0	194,0 ⁽¹⁾	166,0	173,0 ⁽¹⁾	151,0	154,0 ⁽¹⁾	139,0	140,0	121,0*	127,0 ⁽¹⁾	112,0*	114,0 ⁽¹⁾	102,0*	102,0*
	BV	209,0	231,0 ⁽¹⁾	188,0	206,0 ⁽¹⁾	180,0	190,0 ⁽¹⁾	166,0	171,0 ⁽¹⁾	152,0	154,0 ⁽¹⁾	139,0	139,0						
	BW	211,0	236,0 ⁽¹⁾	189,0	203,0 ⁽²⁾	181,0	191,0 ⁽¹⁾	166,0	172,0 ⁽¹⁾	153,0	155,0 ⁽¹⁾	140,0	140,0	122,0*	127,0 ⁽¹⁾	112,0*	114,0 ⁽¹⁾	102,0*	102,0*
28	B	211,0	241,0 ⁽¹⁾	184,0	210,0 ⁽²⁾	174,0	193,0 ⁽¹⁾	161,0	173,0 ⁽¹⁾	147,0	154,0 ⁽¹⁾	135,0	138,0 ⁽¹⁾	124,0	125,0 ⁽¹⁾	108,0*	112,0 ⁽¹⁾	98,6*	101,0 ⁽¹⁾
	BV	209,0	238,0 ⁽¹⁾	181,0	203,0 ⁽¹⁾	174,0	187,0 ⁽¹⁾	160,0	169,0 ⁽¹⁾	147,0	152,0 ⁽¹⁾	135,0	138,0 ⁽¹⁾	124,0	124,0	114,0	114,0		
	BW	211,0	235,0 ⁽¹⁾	181,0	200,0 ⁽²⁾	175,0	188,0 ⁽¹⁾	161,0	170,0 ⁽¹⁾	148,0	153,0 ⁽¹⁾	136,0	138,0 ⁽¹⁾	125,0	125,0	109,0*	113,0 ⁽¹⁾	99,4*	102,0 ⁽¹⁾
30	B	235,0 ⁽¹⁾	178,0	209,0 ⁽²⁾	169,0	192,0 ⁽¹⁾	156,0	172,0 ⁽¹⁾	144,0	153,0 ⁽¹⁾	132,0	138,0 ⁽¹⁾	121,0	124,0 ⁽¹⁾	111,0	111,0	101,0	101,0	
	BV	227,0 ⁽¹⁾	176,0	200,0 ⁽¹⁾	168,0	185,0 ⁽¹⁾	155,0	167,0 ⁽¹⁾	143,0	150,0 ⁽¹⁾	131,0	136,0 ⁽¹⁾	121,0	123,0 ⁽¹⁾	111,0	111,0	101,0	101,0	
	BW	230,0 ⁽¹⁾	177,0	197,0 ⁽²⁾	169,0	186,0 ⁽¹⁾	155,0	167,0 ⁽¹⁾	144,0	151,0 ⁽¹⁾	132,0	137,0 ⁽¹⁾	122,0	123,0 ⁽¹⁾	112,0	112,0	102,0	102,0	
32	B	229,0 ⁽¹⁾	173,0	207,0 ⁽²⁾	164,0	191,0 ⁽¹⁾	151,0	171,0 ⁽¹⁾	139,0	152,0 ⁽¹⁾	128,0	137,0 ⁽¹⁾	118,0	124,0 ⁽¹⁾	108,0	108,0	98,6	98,6	
	BV	226,0 ⁽¹⁾	169,0	199,0 ⁽¹⁾	162,0	182,0 ⁽¹⁾	150,0	164,0 ⁽¹⁾	138,0	148,0 ⁽¹⁾	128,0	134,0 ⁽¹⁾	118,0	121,0 ⁽¹⁾	108,0	110,0 ⁽¹⁾	98,4	99,0 ⁽¹⁾	
	BW	227,0 ⁽¹⁾	170,0	194,0 ⁽²⁾	163,0	183,0 ⁽¹⁾	150,0	165,0 ⁽¹⁾	139,0	149,0 ⁽¹⁾	129,0	135,0 ⁽¹⁾	119,0	120,0 ⁽¹⁾	109,0	110,0 ⁽¹⁾	99,5	99,5	
34	B	223,0 ⁽¹⁾	178,0	203,0 ⁽²⁾	159,0	187,0 ⁽¹⁾	147,0	170,0 ⁽¹⁾	135,0	152,0 ⁽¹⁾	125,0	136,0 ⁽¹⁾	115,0	123,0 ⁽¹⁾	106,0	106,0	96,3	96,3	
	BV	225,0 ⁽¹⁾	178,0	198,0 ⁽¹⁾	157,0	181,0 ⁽¹⁾	145,0	162,0 ⁽¹⁾	134,0	146,0 ⁽¹⁾	124,0	132,0 ⁽¹⁾	114,0	120,0 ⁽¹⁾	106,0	109,0 ⁽¹⁾	96,1	97,8 ⁽¹⁾	
	BW	224,0 ⁽¹⁾	178,0	194,0 ⁽²⁾	158,0	182,0 ⁽¹⁾	145,0	165,0 ⁽¹⁾	134,0	147,0 ⁽¹⁾	125,0	133,0 ⁽¹⁾	115,0	118,0 ⁽¹⁾	106,0	108,0 ⁽¹⁾	97,3	97,3	
36	B	217,0 ⁽¹⁾	177,0	199,0 ⁽²⁾	154,0	183,0 ⁽¹⁾	143,0	167,0 ⁽¹⁾	131,0	151,0 ⁽¹⁾	122,0	136,0 ⁽¹⁾	112,0	123,0 ⁽¹⁾	103,0	106,0 ⁽¹⁾	94,2	94,2	
	BV	224,0 ⁽¹⁾	177,0	197,0 ⁽¹⁾	154,0	180,0 ⁽¹⁾	140,0	161,0 ⁽¹⁾	130,0	144,0 ⁽¹⁾	120,0	131,0 ⁽¹⁾	111,0	118,0 ⁽¹⁾	103,0	108,0 ⁽¹⁾	93,7	96,7 ⁽¹⁾	
	BW	221,0 ⁽¹⁾	177,0	193,0 ⁽²⁾	155,0	181,0 ⁽¹⁾	140,0	161,0 ⁽¹⁾	130,0	145,0 ⁽¹⁾	121,0	131,0 ⁽¹⁾	112,0	116,0 ⁽²⁾	104,0	105,0 ⁽¹⁾	94,8	95,0 ⁽¹⁾	
38	B	211,0 ⁽¹⁾	175,0	195,0 ⁽²⁾	151,0	180,0 ⁽¹⁾	138,0	165,0 ⁽¹⁾	127,0	149,0 ⁽¹⁾	118,0	135,0 ⁽¹⁾	109,0	122,0 ⁽¹⁾	101,0	105,0 ⁽²⁾	91,8	93,7 ⁽²⁾	
	BV	222,0 ⁽¹⁾	169,0	196,0 ⁽¹⁾	149,0	179,0 ⁽¹⁾	137,0	160,0 ⁽¹⁾	125,0	143,0 ⁽¹⁾	116,0	129,0 ⁽¹⁾	108,0	117,0 ⁽¹⁾	100,0	106,0 ⁽¹⁾	91,4	95,5 ⁽¹⁾	
	BW	220,0 ⁽²⁾	170,0	192,0 ⁽²⁾	151,0	180,0 ⁽¹⁾	137,0	160,0 ⁽¹⁾	126,0	143,0 ⁽¹⁾	117,0	130,0 ⁽¹⁾	109,0	115,0 ⁽²⁾	101,0	104,0 ⁽²⁾	92,1	96,2 ⁽²⁾	
40	B	197,0 ⁽¹⁾	186,0 ⁽²⁾	172,0 ⁽¹⁾	163,0	172,0 ⁽¹⁾	131,0	159,0 ⁽¹⁾	120,0	145,0 ⁽¹⁾	111,0	131,0 ⁽²⁾	103,0	120,0 ⁽¹⁾	96,0	105,0 ⁽²⁾	87,4	93,5 ⁽²⁾	
	BV	216,0 ⁽¹⁾	191,0 ⁽¹⁾	177,0 ⁽¹⁾	164,0	177,0 ⁽¹⁾	129,0	158,0 ⁽¹⁾	118,0	141,0 ⁽¹⁾	109,0	127,0 ⁽¹⁾	102,0	114,0 ⁽¹⁾	94,5	104,0 ⁽¹⁾	86,9	93,2 ⁽¹⁾	
	BW	214,0 ⁽²⁾	191,0 ⁽²⁾	178,0 ⁽¹⁾	165,0	178,0 ⁽¹⁾	130,0	158,0 ⁽¹⁾	118,0	140,0 ⁽¹⁾	110,0	125,0 ⁽¹⁾	103,0	112,0 ⁽²⁾	95,3	102,0 ⁽²⁾	87,1	91,5 ⁽²⁾	
42	B	184,0 ⁽³⁾	172,0 ⁽²⁾	163,0 ⁽²⁾	153,0	163,0 ⁽²⁾	135,0	153,0 ⁽¹⁾	113,0	140,0 ⁽¹⁾	105,0	127,0 ⁽²⁾	98,1	116,0 ⁽²⁾	90,3	105,0 ⁽²⁾	83,3	93,2 ⁽²⁾	
	BV	209,0 ⁽¹⁾	187,0 ⁽²⁾	175,0 ⁽¹⁾	165,0	175,0 ⁽¹⁾	130,0	157,0 ⁽¹⁾	113,0	140,0 ⁽¹⁾	103,0	126,0 ⁽¹⁾	95,7	113,0 ⁽¹⁾	89,0	108,0 ⁽¹⁾	81,8	91,0 ⁽¹⁾	
	BW	208,0 ⁽²⁾	187,0 ⁽²⁾	175,0 ⁽¹⁾	165,0	175,0 ⁽¹⁾	130,0	156,0 ⁽¹⁾	113,0	137,0 ⁽²⁾	104,0	123,0 ⁽²⁾	96,8	110,0 ⁽²⁾	89,6	99,8 ⁽²⁾	82,6	89,4 ⁽²⁾	
44	B	168,0 ⁽³⁾	162,0 ⁽¹⁾	153,0 ⁽¹⁾	145,0 ⁽¹⁾	145,0 ⁽¹⁾	108,0	134,0 ⁽¹⁾	108,0	134,0 ⁽¹⁾	99,5	124,0 ⁽²⁾	92,3	114,0 ⁽²⁾	85,9	104,0 ⁽²⁾	78,8	92,9 ⁽²⁾	
	BV	203,0 ⁽¹⁾	183,0 ⁽²⁾	172,0 ⁽¹⁾	165,0	172,0 ⁽¹⁾	107,0	155,0 ⁽¹⁾	107,0	138,0 ⁽¹⁾	98,6	124,0 ⁽¹⁾	90,2	111,0 ⁽¹⁾	83,9	101,0 ⁽¹⁾	77,2	89,7 ⁽¹⁾	
	BW	202,0 ⁽¹⁾	184,0 ⁽²⁾	172,0 ⁽¹⁾	165,0	172,0 ⁽¹⁾	108,0	154,0 ⁽¹⁾	108,0	136,0 ⁽¹⁾	99,7	122,0 ⁽²⁾	90,2	109,0 ⁽²⁾	84,7	104,0 ⁽²⁾	78,2	87,3 ⁽²⁾	
46	B	152,0 ⁽³⁾	150,0 ⁽¹⁾	145,0 ⁽¹⁾	136,0 ⁽¹⁾	136,0 ⁽¹⁾	108,0	136,0 ⁽¹⁾	108,0	128,0 ⁽¹⁾	95,5	121,0 ⁽²⁾	87,4	111,0 ⁽²⁾	81,6	102,0 ⁽²⁾	75,0	91,1 ⁽²⁾	
	BV	196,0 ⁽¹⁾	179,0 ⁽²⁾	168,0 ⁽¹⁾	154,0	168,0 ⁽¹⁾	107,0	154,0 ⁽¹⁾	107,0	137,0 ⁽¹⁾	93,2	123,0 ⁽¹⁾	86,4	110,0 ⁽¹⁾	79,4	99,1 ⁽¹⁾	72,8	88,4 ⁽¹⁾	
	BW	196,0 ⁽¹⁾	180,0 ⁽²⁾	168,0 ⁽¹⁾	152,0 ⁽¹⁾	168,0 ⁽¹⁾	107,0	152,0 ⁽¹⁾	107,0	134,0 ⁽²⁾	94,1	121,0 ⁽²⁾	87,2	108,0 ⁽²⁾	80,2	97,6 ⁽²⁾	74,0	86,3 ⁽²⁾	
48	B	137,0 ⁽³⁾	138,0 ⁽¹⁾	136,0 ⁽¹⁾	128,0 ⁽¹⁾	128,0 ⁽¹⁾	108,0	128,0 ⁽¹⁾	108,0	121,0 ⁽¹⁾	115,0 ⁽¹⁾	115,0 ⁽¹⁾	83,5	108,0 ⁽¹⁾	77,4	99,8 ⁽¹⁾	71,4	89,1 ⁽¹⁾	
	BV	187,0 ⁽²⁾	176,0 ⁽²⁾	165,0 ⁽¹⁾	152,0 ⁽¹⁾	165,0 ⁽¹⁾	107,0	152,0 ⁽¹⁾	107,0	133,0 ⁽²⁾	104,0	120,0 ⁽²⁾	82,9	107,0 ⁽²⁾	77,5	96,7 ⁽²⁾	69,2	85,5 ⁽²⁾	
	BW	185,0 ⁽¹⁾	176,0 ⁽²⁾	165,0 ⁽¹⁾	150,0 ⁽¹⁾	165,0 ⁽¹⁾	107,0	150,0 ⁽¹⁾	107,0	133,0 ⁽²⁾	104,0	120,0 ⁽²⁾	82,9	107,0 ⁽²⁾	77,5	96,7 ⁽²⁾	69,2	85,5 ⁽²⁾	
50	B	125,0 ⁽¹⁾	125,0 ⁽¹⁾	125,0 ⁽¹⁾	122,0 ⁽¹⁾	122,0 ⁽¹⁾	108,0	122,0 ⁽¹⁾	108,0	115,0 ⁽¹⁾	109,0 ⁽¹⁾	109,0 ⁽¹⁾	80,7	103,0 ⁽¹⁾	74,0	96,8 ⁽¹⁾	66,8	81,1 ⁽¹⁾	
	BV	174,0 ⁽¹⁾	172,0 ⁽¹⁾	162,0 ⁽¹⁾	151,0 ⁽¹⁾	162,0 ⁽¹⁾	107,0	151,0 ⁽¹⁾	107,0	135,0 ⁽¹⁾	107,0	121,0 ⁽¹⁾	77,9	108,0 ⁽¹⁾	72,1	95,0 ⁽¹⁾	66,4	84,1 ⁽¹⁾	
	BW	170,0 ⁽¹⁾	170,0 ⁽¹⁾	162,0 ⁽¹⁾	148,0 ⁽¹⁾	162,0 ⁽¹⁾	107,0	148,0 ⁽¹⁾	107,0	131,0 ⁽²⁾	107,0	119,0 ⁽²⁾	79,0	106,0 ⁽²⁾	73,4	95,8 ⁽²⁾	66,7	84,8 ⁽²⁾	
52	B	113,0 ⁽¹⁾	113,0 ⁽¹⁾																

SDWB/SDWBV/SDWBW

S 102

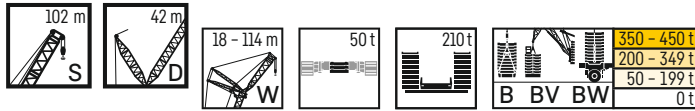

m		S 102 m																
		W 72 m		W 78 m		W 84 m		W 90 m		W 96 m		W 102 m		W 108 m		W 114 m		
		87°/85	WVmax	87°/85	WVmax	87°/85	WVmax	87°/85	WVmax	87°/85	WVmax	87°/85	WVmax	87°/85	WVmax	87°/85	WVmax	
28	B	91,7*	91,7*															
	BV																	
	BW	91,6*	91,6*															
30	B	90,1*	90,6 ⁽¹⁾	81,7*	81,7*													
	BV																	
	BW	89,7*	90,5 ⁽¹⁾	82,1*	82,1*													
32	B	87,9*	89,9 ⁽¹⁾	80,0*	80,8 ⁽¹⁾	73,0*	73,0*	64,7*	64,7*									
	BV																	
	BW	87,7*	89,9 ⁽¹⁾	80,3*	81,3 ⁽¹⁾	73,3*	73,3*	64,9*	64,9*									
34	B	89,6	89,6	78,1*	80,0 ⁽¹⁾	71,4*	72,2 ⁽¹⁾	63,4*	63,4*	57,3*	57,3*							
	BV	89,2	89,2															
	BW	89,6	89,6	78,6*	80,7 ⁽¹⁾	71,7*	72,7 ⁽¹⁾	63,7*	63,7*	57,4*	57,4*							
36	B	88,2	88,9 ⁽¹⁾	79,8	79,8	69,3*	71,3 ⁽¹⁾	62,1*	63,0 ⁽¹⁾	56,2*	56,2*	50,1*	50,1*	25,4*	25,4*			
	BV	87,3	87,8 ⁽¹⁾	78,5	78,5													
	BW	87,8	87,8	80,4	80,4	69,6*	72,0 ⁽¹⁾	62,5*	63,5 ⁽¹⁾	56,5*	56,8 ⁽¹⁾	50,1*	50,1*	25,4*	25,4*			
38	B	86,3	88,6 ⁽¹⁾	78,2	78,2	70,9	70,9	60,8*	62,5 ⁽¹⁾	55,1*	56,0 ⁽¹⁾							
	BV	85,3	86,8 ⁽¹⁾	76,8	77,4 ⁽¹⁾	69,4	69,4											
	BW	85,9	85,9	78,8	78,8	71,4	71,4	61,2*	63,1 ⁽¹⁾	55,4*	56,4 ⁽¹⁾	49,3*	49,7 ⁽¹⁾	42,4*	42,4*	34,7*	34,7*	
40	B	84,6	88,2 ⁽¹⁾	76,6	76,6	69,1	69,1	62,2	62,2	53,9*	55,4 ⁽¹⁾							
	BV	83,3	85,8 ⁽¹⁾	75,1	76,4 ⁽¹⁾	68,0	68,5 ⁽¹⁾	60,7	60,7	54,0	54,0							
	BW	84,0	84,0	77,2	77,2	69,5	69,5	62,6	62,6	54,2*	56,0 ⁽¹⁾	48,1*	49,4 ⁽¹⁾	41,7*	42,1 ⁽¹⁾	33,9*	33,9*	
44	B	81,1	87,6 ⁽¹⁾	73,7	74,5 ⁽²⁾	66,2	66,2	59,8	59,8	54,0	54,0							
	BV	79,2	83,7 ⁽¹⁾	71,6	74,6 ⁽¹⁾	64,9	66,8 ⁽¹⁾	58,2	59,2 ⁽¹⁾	51,9	52,3 ⁽¹⁾	45,4	45,4	39,8	39,8			
	BW	80,1	82,0 ⁽²⁾	73,9	74,4 ⁽²⁾	66,5	66,5	60,3	60,3	54,4	54,4	48,6	48,6	41,9	41,9	32,3*	33,2 ⁽¹⁾	
48	B	77,6	86,9 ⁽¹⁾	70,3	74,4 ⁽²⁾	63,5	65,3 ⁽²⁾	57,4	57,8 ⁽²⁾	51,9	51,9							
	BV	75,0	81,6 ⁽¹⁾	68,0	72,7 ⁽¹⁾	61,8	65,2 ⁽¹⁾	55,5	57,7 ⁽¹⁾	49,6	51,0 ⁽¹⁾	43,5	44,3 ⁽¹⁾	38,1	38,5 ⁽¹⁾	32,2	32,4 ⁽¹⁾	
	BW	76,1	80,2 ⁽²⁾	70,1	72,6 ⁽²⁾	63,6	64,8 ⁽²⁾	57,8	58,0 ⁽²⁾	52,3	52,3	46,1	46,1	40,3	40,3	32,4	32,4	
52	B	74,1	83,7 ⁽²⁾	66,5	74,2 ⁽²⁾	61,0	65,2 ⁽²⁾	55,2	57,6 ⁽²⁾	49,8	50,9 ⁽²⁾							
	BV	70,9	80,1 ⁽¹⁾	64,3	70,9 ⁽¹⁾	58,7	63,5 ⁽¹⁾	52,8	56,2 ⁽¹⁾	47,2	49,6 ⁽¹⁾	41,5	43,1 ⁽¹⁾	36,4	37,4 ⁽¹⁾	30,7	31,4 ⁽¹⁾	
	BW	72,2	78,7 ⁽²⁾	65,9	70,8 ⁽²⁾	60,7	63,5 ⁽²⁾	55,2	56,9 ⁽²⁾	50,2	50,8 ⁽²⁾	43,4	43,4	38,8	38,8	30,9	31,1 ⁽¹⁾	
56	B	69,6	83,3 ⁽²⁾	63,5	74,1 ⁽²⁾	58,3	65,1 ⁽²⁾	52,9	57,5 ⁽²⁾	47,3	50,8 ⁽²⁾							
	BV	66,9	78,8 ⁽¹⁾	60,8	69,8 ⁽¹⁾	55,6	62,1 ⁽¹⁾	50,0	54,7 ⁽¹⁾	44,8	48,3 ⁽¹⁾	39,4	41,8 ⁽¹⁾	34,5	36,3 ⁽¹⁾	29,2	30,4 ⁽¹⁾	
	BW	67,6	77,2 ⁽²⁾	62,5	69,0 ⁽²⁾	57,8	62,2 ⁽²⁾	52,7	55,7 ⁽²⁾	47,5	49,6 ⁽²⁾	41,5	42,5 ⁽²⁾	37,2	37,2 ⁽²⁾	29,3	29,9 ⁽¹⁾	
60	B	66,0	81,7 ⁽²⁾	60,2	73,4 ⁽²⁾	55,7	65,0 ⁽²⁾	50,6	57,4 ⁽²⁾	44,5	50,6 ⁽²⁾							
	BV	63,1	77,6 ⁽¹⁾	57,4	68,6 ⁽¹⁾	52,5	61,0 ⁽¹⁾	47,3	53,7 ⁽¹⁾	42,4	47,1 ⁽¹⁾	37,3	39,5 ⁽²⁾	32,7	35,1 ⁽¹⁾	27,8	29,5 ⁽¹⁾	
	BW	63,7	76,5 ⁽²⁾	59,4	67,7 ⁽²⁾	54,9	60,9 ⁽²⁾	50,2	54,5 ⁽²⁾	44,4	48,5 ⁽²⁾	39,6	41,5 ⁽²⁾	35,5	36,7 ⁽²⁾	27,8	28,7 ⁽²⁾	
64	B	62,8	80,1 ⁽²⁾	57,4	72,2 ⁽²⁾	52,8	64,3 ⁽²⁾	47,8	57,2 ⁽²⁾	42,3	50,5 ⁽²⁾							
	BV	59,7	74,7 ⁽²⁾	54,1	67,4 ⁽¹⁾	49,5	59,9 ⁽¹⁾	44,6	52,6 ⁽¹⁾	40,0	46,1 ⁽¹⁾	35,1	38,4 ⁽²⁾	30,8	33,1 ⁽²⁾	26,4	28,5 ⁽¹⁾	
	BW	60,6	75,8 ⁽²⁾	56,2	67,1 ⁽²⁾	52,0	60,2 ⁽²⁾	47,2	53,5 ⁽²⁾	42,0	47,3 ⁽²⁾	37,6	40,6 ⁽²⁾	33,8	35,9 ⁽²⁾	26,2	28,1 ⁽²⁾	
68	B	59,6	78,5 ⁽²⁾	54,6	71,0 ⁽²⁾	50,2	63,6 ⁽²⁾	44,5	56,6 ⁽²⁾	40,3	50,2 ⁽²⁾							
	BV	57,7	74,0 ⁽²⁾	51,2	65,0 ⁽²⁾	46,7	58,9 ⁽¹⁾	42,0	51,1 ⁽¹⁾	37,7	45,1 ⁽¹⁾	33,0	37,4 ⁽²⁾	29,1	32,2 ⁽²⁾	25,0	27,0 ⁽²⁾	
	BW	58,6	75,1 ⁽²⁾	53,5	66,4 ⁽²⁾	49,3	59,5 ⁽²⁾	43,8	52,9 ⁽²⁾	39,8	46,3 ⁽²⁾	35,7	39,7 ⁽²⁾	32,1	35,0 ⁽²⁾	24,6	27,6 ⁽²⁾	
72	B	56,7	75,4 ⁽³⁾	51,8	69,7 ⁽²⁾	46,9	62,8 ⁽²⁾	42,1	56,0 ⁽²⁾	38,2	49,6 ⁽²⁾							
	BV	54,4	73,5 ⁽²⁾	49,3	64,4 ⁽²⁾	44,1	56,9 ⁽¹⁾	39,6	49,7 ⁽²⁾	35,4	44,1 ⁽¹⁾	31,0	36,8 ⁽²⁾	27,4	31,3 ⁽²⁾	23,5	26,3 ⁽²⁾	
	BW	55,5	74,5 ⁽²⁾	51,7	65,7 ⁽²⁾	45,8	58,9 ⁽²⁾	41,5	52,2 ⁽²⁾	37,7	45,4 ⁽²⁾	33,8	39,1 ⁽²⁾	30,3	34,2 ⁽²⁾	23,1	27,0 ⁽²⁾	
76	B	54,4	72,6 ⁽³⁾	49,5	66,2 ⁽³⁾	44,2	61,8 ⁽²⁾	40,0	55,4 ⁽²⁾	36,3	49,0 ⁽²⁾							
	BV	51,3	73,2 ⁽²⁾	46,5	64,0 ⁽²⁾	42,3	56,3 ⁽²⁾	37,2	49,1 ⁽²⁾	33,3	42,6 ⁽²⁾	29,1	36,3 ⁽²⁾	25,9	30,8 ⁽²⁾	22,1	25,7 ⁽²⁾	
	BW	52,7	74,1 ⁽²⁾	49,3	65,3 ⁽²⁾	43,9	58,2 ⁽²⁾	39,3	51,6 ⁽²⁾	35,8	44,6 ⁽²⁾	32,1	38,6 ⁽²⁾	28,5	33,4 ⁽²⁾	21,6	26,3 ⁽²⁾	
80	B	52,6	70,6 ⁽⁴⁾	46,1	63,6 ⁽³⁾	42,2	59,6 ⁽³⁾	38,1	54,2 ⁽²⁾	34,5	48,5 ⁽²⁾							
	BV	48,6	72,9 ⁽²⁾	43,8	63,7 ⁽²⁾	40,1	56,1 ⁽²⁾	35,0	48,5 ⁽²⁾	31,2	42,1 ⁽²⁾	27,5	35,8 ⁽²⁾	24,4	30,4 ⁽²⁾	20,7	25,3 ⁽²⁾	
	BW	50,2	73,8 ⁽²⁾	45,6	65,0 ⁽²⁾	41,9	58,0 ⁽²⁾	37,8	51,0 ⁽²⁾	33,8	43,8 ⁽²⁾	30,3	38,0 ⁽²⁾	26,7	32,7 ⁽²⁾	20,1	25,4 ⁽³⁾	
88	B		63,7 ⁽⁶⁾	43,0	59,8 ⁽⁵⁾	38,4	55,6 ⁽⁴⁾	34,8	50,6 ⁽⁴⁾	30,9	45,4 ⁽³⁾							
	BV		72,2 ⁽²⁾	39,5	63,2 ⁽²⁾	35,5	55,5 ⁽²⁾	31,6	48,1 ⁽²⁾	27,9	41,5 ⁽²⁾	24,4	34,9 ⁽²⁾	21,5	29,4 ⁽²⁾	18,1	24,5 ⁽²⁾	
	BW		73,2 ⁽²⁾	41,1	64,4 ⁽²⁾	37,5	57,5 ⁽²⁾	34,1	50,2 ⁽²⁾	30,7	42,2 ⁽²⁾	27,0	36,5 ⁽²⁾	23,2	31,1 ⁽²⁾	17,1	24,6 ⁽³⁾	
96	B		58,6 ⁽⁹⁾		55,0 ⁽⁷⁾		51,6 ⁽⁶⁾		31,8	47,0 ⁽⁵⁾	28,4	42,7 ⁽⁴⁾						
	BV		71,6 ⁽²⁾		62,6 ⁽²⁾		55,0 ⁽²⁾		28,0	47,6 ⁽²⁾	25,1	41,0 ⁽²⁾	22,1	34,5 ⁽²⁾	18,9	29,0 ⁽²⁾	15,7	23,9 ⁽²⁾
	BW		72,5 ⁽²⁾		63,8 ⁽²⁾		57,0 ⁽²⁾		30,5	49,4 ⁽²⁾	27,6	41,5 ⁽³⁾	24,5	35,3 ⁽³⁾	20,3	30,5 ⁽³⁾	14,4	23,5 ⁽³⁾
104	B		51,9 ⁽¹¹⁾		50,8 ⁽¹⁰⁾		46,7 ⁽⁸⁾			42,0 ⁽⁷⁾	26,1	39,0 ⁽⁶⁾						
	BV		69,4 ⁽⁴⁾		61,6 ⁽³⁾		54,5 ⁽²⁾			47,1 ⁽²⁾	22,5	40,6 ⁽²⁾	19,3	34,1 ⁽²⁾	16,8	28,7 ⁽²⁾	13,7	23,6 ⁽²⁾
	BW		69,0 ⁽⁴⁾		63,0 ⁽³⁾		56,5 ⁽²⁾			48,9 ⁽³⁾	24,2	41,6 ⁽³⁾	20,7	34,8 ⁽³⁾	18,2	29,3 ⁽³⁾	12,2	22,8 ⁽⁴⁾
112	B		41,6 ⁽¹¹⁾		42,6 ⁽¹¹⁾		43,1 ⁽¹¹⁾			39,1 ⁽⁹⁾		36,3 ⁽⁷⁾						
	BV		65,7 ⁽⁶⁾		59,2 ⁽⁵⁾		53,0 ⁽⁴⁾			46,6 ⁽³⁾		40,1 ⁽²⁾	17,4	33,6 ⁽²⁾	14,5	28,3 ⁽²⁾	11,5	23,3 ⁽²⁾
	BW		65,6 ⁽⁶⁾		60,2 ⁽⁵⁾		54,9 ⁽⁴⁾			49,0 ⁽³⁾		41,6 ⁽³⁾	18,5	34,3 ⁽³⁾	15,8	29,1 ⁽⁴⁾	10,3	22,3 ⁽⁴⁾
120	B		29,9 ⁽⁹⁾		32,5 ⁽¹¹⁾		33,9 ⁽¹¹⁾			35,3 ⁽¹¹⁾		33,4 ⁽¹⁰⁾						
	BV		60,3 ⁽⁹⁾		55,9 ⁽⁸⁾		50,8 ⁽⁶⁾			44,8 ⁽⁴⁾								

SDWB/SDWBV/SDWBW

S 108

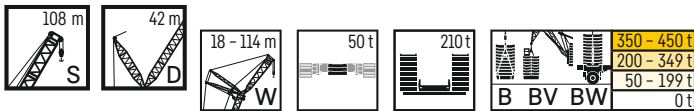

m	S 108 m																	
	W 18 m		W 24 m		W 30 m		W 36 m		W 42 m		W 48 m		W 54 m		W 60 m		W 66 m	
	87°/85	WVmax	87°/85	WVmax	87°/85	WVmax	87°/85	WVmax	87°/85	WVmax	87°/85	WVmax	87°/85	WVmax	87°/85	WVmax	87°/85	WVmax
16	B	218,0*	218,0*															
	BV	218,0*	218,0*															
	BW	218,0*	218,0*															
18	B	210,0*	219,0 ⁽¹⁾	191,0*	194,0 ⁽¹⁾													
	BV	210,0*	219,0 ⁽¹⁾	191,0*	194,0 ⁽¹⁾													
	BW	210,0*	219,0 ⁽¹⁾	191,0*	194,0 ⁽¹⁾													
20	B	218,0	219,0 ⁽¹⁾	184,0*	193,0 ⁽¹⁾													
	BV	215,0	215,0	184,0*	193,0 ⁽¹⁾	173,0*	176,0 ⁽¹⁾	157,0*	157,0*									
	BW	215,0	215,0	184,0*	193,0 ⁽¹⁾	173,0*	176,0 ⁽¹⁾	157,0*	157,0*									
22	B	211,0	218,0 ⁽¹⁾	191,0	191,0													
	BV	207,0	211,0 ⁽¹⁾	188,0	188,0													
	BW	207,0	210,0 ⁽²⁾	189,0	190,0 ⁽¹⁾	168,0*	174,0 ⁽¹⁾	153,0*	156,0 ⁽¹⁾	139,0*	139,0*	127,0*	127,0*					
24	B	204,0	216,0 ⁽¹⁾	185,0	187,0 ⁽²⁾													
	BV	198,0	207,0 ⁽¹⁾	180,0	186,0 ⁽¹⁾	170,0	171,0 ⁽¹⁾	154,0	154,0									
	BW	192,0	206,0 ⁽²⁾	181,0	185,0 ⁽¹⁾	171,0	172,0 ⁽¹⁾	148,0*	154,0 ⁽¹⁾	135,0*	138,0 ⁽¹⁾	124,0*	125,0 ⁽¹⁾	112,0*	112,0*			
26	B	198,0	215,0 ⁽¹⁾	179,0	186,0 ⁽²⁾													
	BV	190,0	203,0 ⁽¹⁾	173,0	182,0 ⁽¹⁾	164,0	168,0 ⁽¹⁾	150,0	151,0 ⁽¹⁾	137,0	137,0	121,0*	124,0 ⁽¹⁾	110,0*	111,0 ⁽¹⁾	101,0*	101,0*	
	BW	191,0	202,0 ⁽²⁾	174,0	181,0 ⁽¹⁾	165,0	169,0 ⁽¹⁾	151,0	152,0 ⁽²⁾	137,0	137,0	121,0*	124,0 ⁽¹⁾	110,0*	111,0 ⁽¹⁾	101,0*	101,0*	
28	B	191,0	215,0 ⁽¹⁾	173,0	186,0 ⁽²⁾													
	BV	185,0	199,0 ⁽¹⁾	166,0	178,0 ⁽¹⁾	159,0	165,0 ⁽¹⁾	145,0	149,0 ⁽¹⁾	133,0	134,0 ⁽¹⁾	122,0	122,0	107,0*	110,0 ⁽¹⁾	98,2*	99,7 ⁽¹⁾	89,1*
	BW	185,0	198,0 ⁽²⁾	167,0	176,0 ⁽¹⁾	160,0	166,0 ⁽¹⁾	146,0	150,0 ⁽¹⁾	133,0	134,0 ⁽¹⁾	123,0	123,0	107,0*	110,0 ⁽¹⁾	98,2*	99,7 ⁽¹⁾	89,1*
30	B	187,0	214,0 ⁽¹⁾	167,0	185,0 ⁽²⁾													
	BV	178,0	195,0 ⁽¹⁾	158,0	175,0 ⁽¹⁾	154,0	162,0 ⁽¹⁾	141,0	146,0 ⁽¹⁾	129,0	132,0 ⁽¹⁾	119,0	120,0 ⁽¹⁾	108,0	108,0	95,7*	98,8 ⁽¹⁾	87,0*
	BW	179,0	194,0 ⁽²⁾	159,0	173,0 ⁽²⁾	154,0	163,0 ⁽¹⁾	142,0	147,0 ⁽¹⁾	129,0	132,0 ⁽¹⁾	120,0	121,0 ⁽¹⁾	109,0	109,0	95,7*	98,8 ⁽¹⁾	87,0*
32	B	210,0 ⁽¹⁾	162,0	184,0 ⁽²⁾														
	BV	196,0 ⁽¹⁾	156,0	171,0 ⁽¹⁾	148,0	160,0 ⁽¹⁾	136,0	144,0 ⁽¹⁾	125,0	130,0 ⁽¹⁾	115,0	118,0 ⁽¹⁾	105,0	106,0 ⁽¹⁾	96,5	96,5	84,9*	87,7 ⁽¹⁾
	BW	191,0 ⁽²⁾	156,0	169,0 ⁽²⁾	149,0	160,0 ⁽¹⁾	137,0	145,0 ⁽¹⁾	126,0	130,0 ⁽¹⁾	117,0	119,0 ⁽¹⁾	106,0	107,0 ⁽¹⁾	97,6	97,6	84,9*	87,7 ⁽¹⁾
34	B	205,0 ⁽¹⁾	167,0	183,0 ⁽²⁾														
	BV	197,0 ⁽¹⁾	149,0	171,0 ⁽¹⁾	143,0	157,0 ⁽¹⁾	132,0	141,0 ⁽¹⁾	122,0	128,0 ⁽¹⁾	112,0	116,0 ⁽¹⁾	102,0	105,0 ⁽¹⁾	94,1	95,2 ⁽¹⁾	85,1	85,1
	BW	192,0 ⁽²⁾	150,0	166,0 ⁽²⁾	144,0	157,0 ⁽¹⁾	132,0	142,0 ⁽²⁾	122,0	128,0 ⁽¹⁾	113,0	117,0 ⁽¹⁾	103,0	106,0 ⁽¹⁾	95,0	95,5 ⁽¹⁾	86,5	86,5
36	B	201,0 ⁽¹⁾	154,0	180,0 ⁽²⁾														
	BV	198,0 ⁽¹⁾	143,0	172,0 ⁽¹⁾	138,0	156,0 ⁽¹⁾	127,0	139,0 ⁽¹⁾	118,0	126,0 ⁽¹⁾	109,0	115,0 ⁽¹⁾	99,6	103,0 ⁽¹⁾	91,6	93,8 ⁽¹⁾	83,0	84,0 ⁽¹⁾
	BW	194,0 ⁽²⁾	144,0	166,0 ⁽²⁾	139,0	156,0 ⁽¹⁾	128,0	140,0 ⁽¹⁾	117,0	126,0 ⁽¹⁾	109,0	115,0 ⁽¹⁾	101,0	102,0 ⁽¹⁾	92,1	93,4 ⁽¹⁾	84,5	84,5
38	B	197,0 ⁽¹⁾	177,0 ⁽²⁾															
	BV	199,0 ⁽¹⁾	173,0 ⁽¹⁾	137,0	156,0 ⁽¹⁾	123,0	138,0 ⁽¹⁾	114,0	124,0 ⁽¹⁾	105,0	113,0 ⁽¹⁾	96,6	102,0 ⁽¹⁾	89,1	92,4 ⁽¹⁾	80,9	82,8 ⁽¹⁾	82,5
	BW	196,0 ⁽²⁾	167,0 ⁽²⁾	137,0	157,0 ⁽¹⁾	124,0	137,0 ⁽¹⁾	113,0	124,0 ⁽¹⁾	106,0	113,0 ⁽¹⁾	97,8	102,0 ⁽¹⁾	89,6	91,2 ⁽¹⁾	82,5	82,5	82,5
40	B	192,0 ⁽²⁾	174,0 ⁽²⁾															
	BV	201,0 ⁽¹⁾	174,0 ⁽¹⁾	132,0	157,0 ⁽¹⁾	120,0	138,0 ⁽¹⁾	110,0	122,0 ⁽¹⁾	102,0	111,0 ⁽¹⁾	93,7	99,9 ⁽¹⁾	86,6	91,0 ⁽¹⁾	78,7	81,5 ⁽¹⁾	81,5 ⁽¹⁾
	BW	197,0 ⁽²⁾	169,0 ⁽²⁾	133,0	157,0 ⁽¹⁾	121,0	139,0 ⁽¹⁾	110,0	122,0 ⁽¹⁾	103,0	112,0 ⁽¹⁾	94,8	98,8 ⁽²⁾	87,1	89,2 ⁽²⁾	80,5	81,0 ⁽²⁾	81,0 ⁽²⁾
44	B	179,0 ⁽⁵⁾	168,0 ⁽²⁾															
	BV	198,0 ⁽¹⁾	175,0 ⁽¹⁾		158,0 ⁽¹⁾	114,0	139,0 ⁽¹⁾	103,0	123,0 ⁽¹⁾	95,8	110,0 ⁽¹⁾	88,1	96,9 ⁽¹⁾	81,6	88,1 ⁽¹⁾	74,4	79,0 ⁽¹⁾	79,0 ⁽¹⁾
	BW	188,0 ⁽⁵⁾	171,0 ⁽²⁾		158,0 ⁽¹⁾	114,0	139,0 ⁽¹⁾	103,0	118,0 ⁽²⁾	96,9	107,0 ⁽¹⁾	88,7	95,9 ⁽²⁾	82,4	86,8 ⁽²⁾	76,4	78,9 ⁽²⁾	78,9 ⁽²⁾
48	B	170,0 ⁽¹¹⁾	159,0 ⁽⁴⁾															
	BV	193,0 ⁽¹¹⁾	171,0 ⁽¹⁾		157,0 ⁽¹⁾	108,0	140,0 ⁽¹⁾	99,4	123,0 ⁽¹⁾	90,4	110,0 ⁽¹⁾	82,9	97,0 ⁽¹⁾	76,8	86,7 ⁽¹⁾	70,1	76,4 ⁽¹⁾	76,4 ⁽¹⁾
	BW	183,0 ⁽¹¹⁾	170,0 ⁽²⁾		157,0 ⁽¹⁾	108,0	140,0 ⁽¹⁾	99,7	119,0 ⁽²⁾	90,7	106,0 ⁽²⁾	83,5	93,0 ⁽²⁾	77,9	84,3 ⁽²⁾	71,7	76,8 ⁽²⁾	76,8 ⁽²⁾
52	B		150,0 ⁽⁷⁾															
	BV	188,0 ⁽¹⁾	167,0 ⁽¹⁾		154,0 ⁽¹⁾		138,0 ⁽¹⁾	93,6	124,0 ⁽¹⁾	86,8	110,0 ⁽¹⁾	77,8	97,1 ⁽¹⁾	72,2	86,6 ⁽¹⁾	66,1	76,2 ⁽¹⁾	76,2 ⁽¹⁾
	BW		166,0 ⁽²⁾		154,0 ⁽¹⁾		138,0 ⁽¹⁾	93,2	120,0 ⁽²⁾	87,3	107,0 ⁽²⁾	78,9	93,8 ⁽²⁾	73,5	82,9 ⁽²⁾	67,2	74,6 ⁽²⁾	74,6 ⁽²⁾
56	B		142,0 ⁽¹⁰⁾															
	BV	183,0 ⁽¹⁾	163,0 ⁽¹⁾		150,0 ⁽¹⁾		135,0 ⁽¹⁾		121,0 ⁽¹⁾	81,6	109,0 ⁽¹⁾	74,5	97,2 ⁽¹⁾	68,1	86,6 ⁽¹⁾	62,2	76,0 ⁽¹⁾	76,0 ⁽¹⁾
	BW		162,0 ⁽²⁾		150,0 ⁽¹⁾		135,0 ⁽¹⁾		121,0 ⁽²⁾	82,4	108,0 ⁽²⁾	76,3	94,6 ⁽²⁾	68,6	83,5 ⁽²⁾	63,5	74,1 ⁽²⁾	74,1 ⁽²⁾
60	B		131,0 ⁽¹⁰⁾															
	BV	179,0 ⁽¹⁾	160,0 ⁽¹⁾		147,0 ⁽¹⁾		132,0 ⁽¹⁾		119,0 ⁽¹⁾	77,8	107,0 ⁽¹⁾	71,0	96,0 ⁽¹⁾	65,9	86,5 ⁽¹⁾	58,5	75,9 ⁽¹⁾	75,9 ⁽¹⁾
	BW		158,0 ⁽²⁾		146,0 ⁽¹⁾		132,0 ⁽¹⁾		118,0 ⁽²⁾	78,5	107,0 ⁽²⁾	72,1	95,5 ⁽²⁾	66,3	84,1 ⁽²⁾	60,2	74,6 ⁽²⁾	74,6 ⁽²⁾
64	B		120,0 ⁽¹⁰⁾															
	BV	170,0 ⁽⁹⁾	155,0 ⁽²⁾		143,0 ⁽¹⁾		129,0 ⁽¹⁾		116,0 ⁽¹⁾		105,0 ⁽¹⁾	67,2	94,1 ⁽¹⁾	62,1	84,9 ⁽¹⁾	56,8	73,3 ⁽¹⁾	73,3 ⁽¹⁾
	BW		155,0 ⁽²⁾		143,0 ⁽¹⁾		129,0 ⁽¹⁾		116,0 ⁽²⁾		105,0 ⁽²⁾	67,4	94,4 ⁽²⁾	62,7	84,7 ⁽²⁾	58,6	75,0 ⁽²⁾	75,0 ⁽²⁾
68	B		110,0 ⁽¹⁰⁾															
	BV	158,0 ⁽⁷⁾	149,0 ⁽³⁾		140,0 ⁽¹⁾		126,0 ⁽¹⁾		114,0 ⁽¹⁾		103,0 ⁽¹⁾		92,2 ⁽¹⁾	58,6	83,3 ⁽¹⁾	53,5	73,7 ⁽¹⁾	73,7 ⁽¹⁾
	BW		148,0 ⁽⁴⁾		139,0 ⁽²⁾		126,0 ⁽¹⁾		114,0 ⁽²⁾		103,0 ⁽²⁾		92,7 ⁽²⁾	59,5	83,5 ⁽²⁾	55,5	75,3 ⁽²⁾	75,3 ⁽²⁾
72	B		98,8 ⁽¹⁰⁾															
	BV	145,0 ⁽⁷⁾	143,0 ⁽⁷⁾		136,0 ⁽³⁾		123,0 ⁽¹⁾		111,0 ⁽²⁾		101,0 ⁽¹⁾		90,4 ⁽¹⁾	56,1	81,7 ⁽¹⁾	50,5	72,4 ⁽¹⁾	72,4 ⁽¹⁾
	BW		142,0 ⁽¹⁰⁾		134,0 ⁽⁴⁾		124,0 ⁽¹⁾		111,0 ⁽²⁾		102,0 ⁽²⁾		90,9 ⁽²⁾	57,0	82,2 ⁽²⁾	52,6	74,0 ⁽²⁾	74,0 ⁽²⁾
76	B																	
	BV	132,0 ⁽⁷⁾	132,0 ⁽⁷⁾		130,0 ⁽⁴⁾		120,0 ⁽³⁾		109,0 ⁽²⁾		99,8 ⁽²⁾		88,7 ⁽²⁾		80,1 ⁽²⁾	47,9	71,2 ⁽²⁾	71,2 ⁽²⁾
	BW				130,0 ⁽⁷⁾		120,0 ⁽³⁾		109,0 ⁽²⁾		99,8 ⁽²⁾		89,2 ⁽²⁾		80,8 ⁽²⁾	50,1	72,7 ⁽²⁾	72,7 ⁽²⁾
80	B																	
	BV	119,0 ⁽⁷⁾			122,0 ⁽⁸⁾		116,0 ⁽⁵⁾		106,0 ⁽³⁾		97,0 ⁽²⁾		87,1 ⁽²⁾		78,6 ⁽²⁾		69,9 ⁽²⁾	69,9 ⁽²⁾
	BW				122,0 ⁽⁸⁾		115,0 ⁽⁵⁾		106,0 ⁽³⁾		97,9 ⁽²⁾		87,4 ⁽²⁾		79,5 ⁽²⁾		71,4 ⁽²⁾	71,4 ⁽²⁾
88	B																	

Hubhöhen

SDWB/SDWBV/SDWBW

Lifting heights • Hauteurs de levage • Altezze di sollevamento • Alturas de elevación • Высота подъема

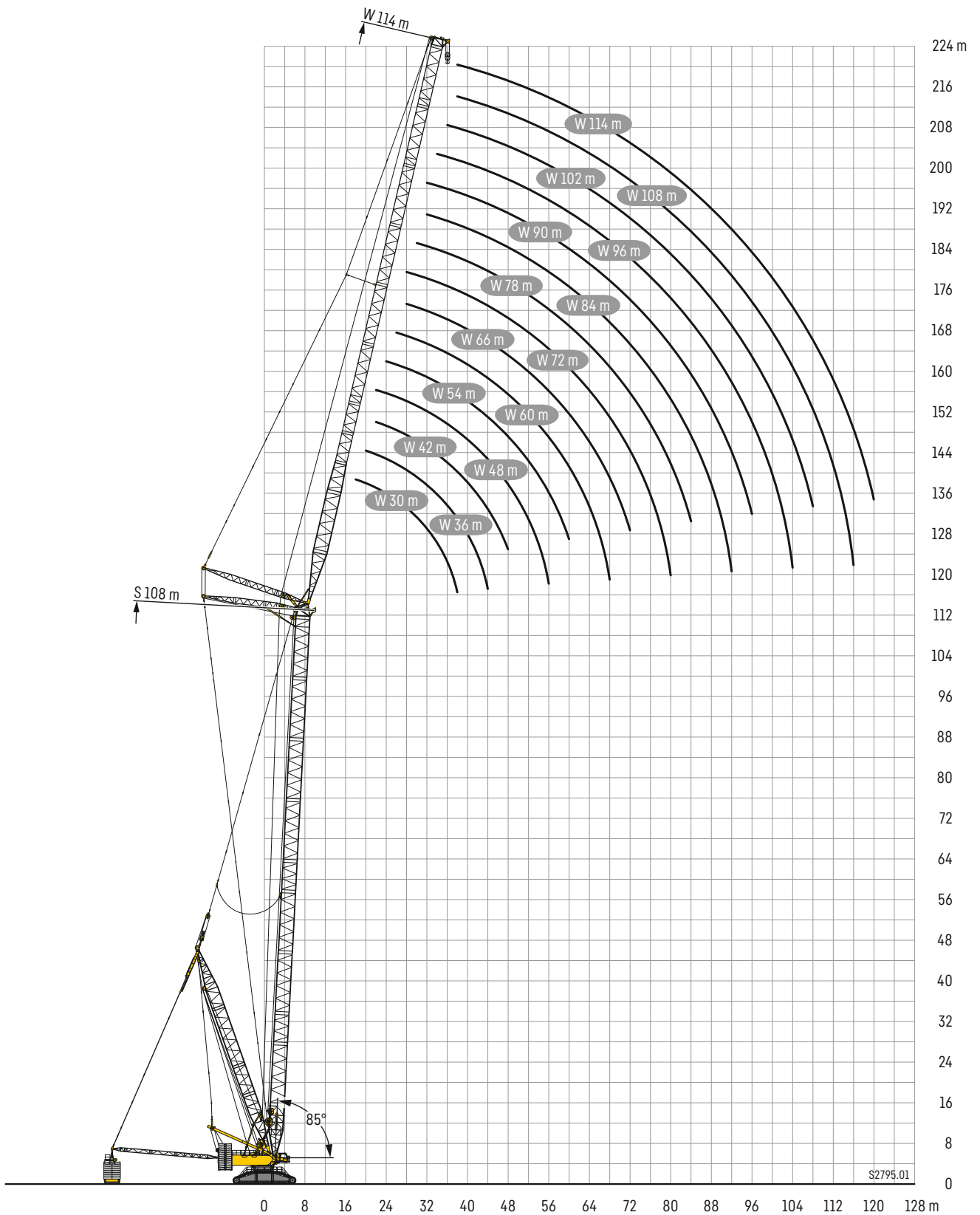

Beispiel

Wmax

Example • Exemple • Esempio • Ejemplo • Пример

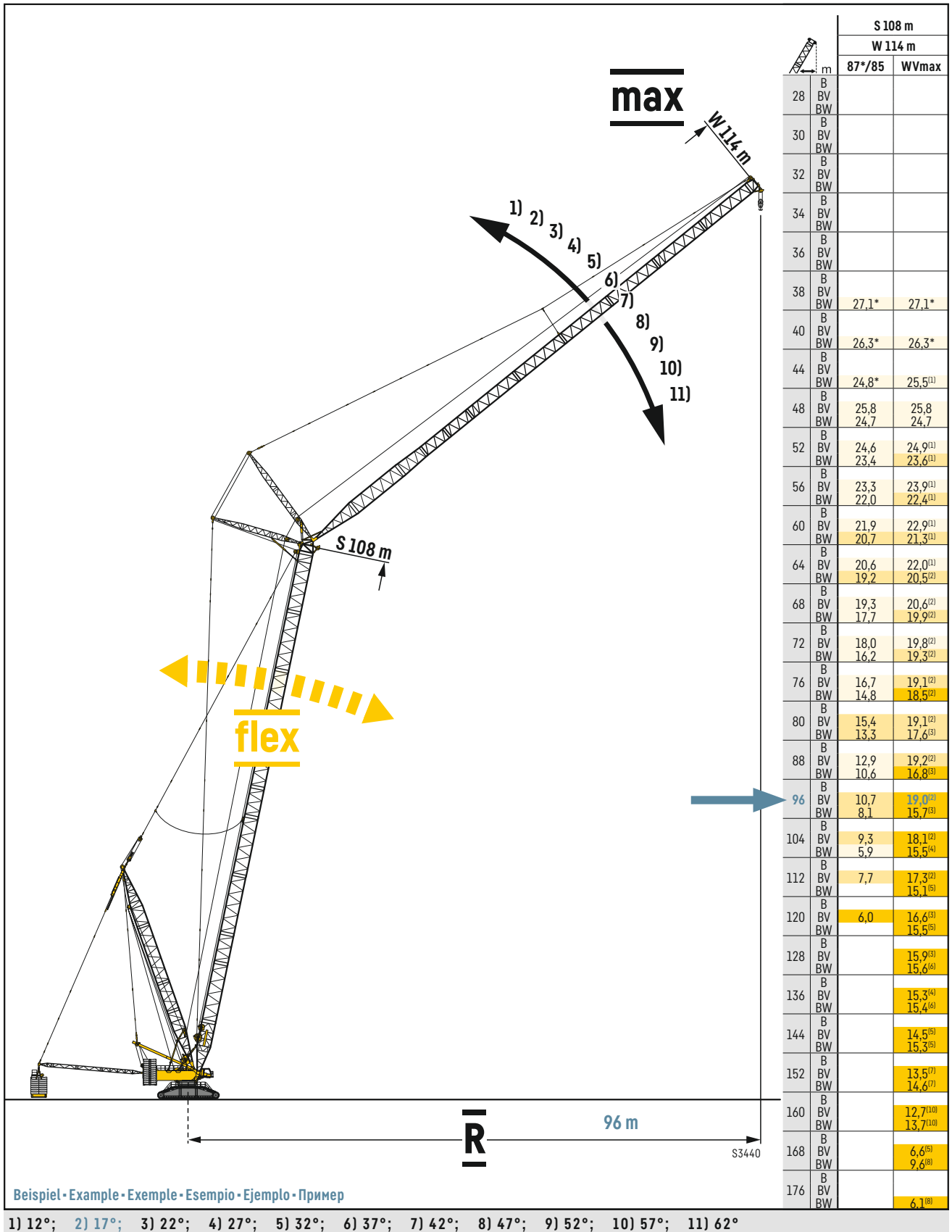

Beispiel • Example • Exemple • Esempio • Ejemplo • Пример

1) 12°; 2) 17°; 3) 22°; 4) 27°; 5) 32°; 6) 37°; 7) 42°; 8) 47°; 9) 52°; 10) 57°; 11) 62°

PDW3B/PDW3BW

P 48

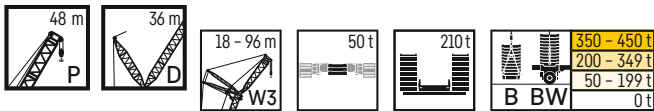

m	B BW	P 48 m													
		W3 18 m		W3 24 m		W3 30 m		W3 36 m		W3 42 m		W3 48 m		W3 54 m	
		87°/85	WVmax	87°/85	WVmax	87°/85	WVmax	87°/85	WVmax	87°/85	WVmax	87°/85	WVmax	87°/85	WVmax
12	B	650,0*	650,0*												
	BW	650,0*	650,0*												
14	B	650,0	650,0	627,0*	627,0*										
	BW	650,0	650,0	631,0*	631,0*										
16	B	634,0	635,0 ⁽²⁾	624,0	624,0	574,0*	574,0*	517,0*	517,0*						
	BW	634,0	648,0 ⁽¹⁾	630,0	630,0	581,0*	581,0*	521,0*	521,0*						
18	B	527,0	585,0 ⁽²⁾	563,0	579,0 ⁽¹⁾	571,0	571,0	505,0*	512,0 ⁽¹⁾	456,0*	456,0*				
	BW	529,0	646,0 ⁽¹⁾	566,0	601,0 ⁽¹⁾	584,0	584,0	510,0*	518,0 ⁽¹⁾	460,0*	460,0*				
20	B	439,0	534,0 ⁽²⁾	470,0	535,0 ⁽¹⁾	531,0	531,0	508,0	508,0	447,0*	454,0 ⁽¹⁾	403,0*	403,0*		
	BW	440,0	641,0 ⁽¹⁾	469,0	573,0 ⁽¹⁾	556,0	560,0 ⁽¹⁾	515,0	515,0	451,0*	459,0 ⁽¹⁾	407,0*	407,0*		
22	B	375,0	486,0 ⁽²⁾	401,0	490,0 ⁽¹⁾	486,0	490,0 ⁽²⁾	478,0	478,0	450,0	450,0	396,0*	403,0 ⁽¹⁾	359,0*	359,0*
	BW	375,0	591,0 ⁽¹⁾	400,0	545,0 ⁽¹⁾	518,0	536,0 ⁽¹⁾	504,0	504,0	457,0	457,0	400,0*	408,0 ⁽¹⁾	363,0*	363,0*
24	B	306,0	445,0 ⁽³⁾	345,0	446,0 ⁽¹⁾	448,0	450,0 ⁽³⁾	442,0	444,0 ⁽²⁾	432,0	432,0	400,0	400,0	363,0	363,0
	BW	306,0	541,0 ⁽¹⁾	347,0	517,0 ⁽¹⁾	478,0	513,0 ⁽¹⁾	481,0	491,0 ⁽¹⁾	447,0	447,0	406,0	406,0	367,0	367,0
26	B		407,0 ⁽⁴⁾	307,0	405,0 ⁽³⁾	414,0	415,0 ⁽⁴⁾	409,0	410,0 ⁽²⁾	403,0	405,0 ⁽²⁾	390,0	390,0	357,0	357,0
	BW		496,0 ⁽¹⁾	308,0	489,0 ⁽¹⁾	432,0	489,0 ⁽²⁾	431,0	480,0 ⁽¹⁾	421,0	434,0 ⁽¹⁾	397,0	402,0 ⁽¹⁾	363,0	363,0
28	B		370,0 ⁽⁴⁾	276,0	372,0 ⁽³⁾	384,0	385,0 ⁽⁵⁾	379,0	381,0 ⁽³⁾	375,0	376,0 ⁽²⁾	369,0	369,0	349,0	349,0
	BW		464,0 ⁽¹⁾	278,0	461,0 ⁽¹⁾	385,0	461,0 ⁽²⁾	385,0	455,0 ⁽⁴⁾	384,0	423,0 ⁽¹⁾	375,0	398,0 ⁽¹⁾	355,0	355,0
30	B		340,0 ⁽³⁾	243,0	339,0 ⁽³⁾	347,0	357,0 ⁽⁵⁾	347,0	354,0 ⁽⁴⁾	346,0	351,0 ⁽³⁾	342,0	344,0 ⁽²⁾	333,0	333,0
	BW		432,0 ⁽¹⁾	243,0	432,0 ⁽¹⁾	348,0	429,0 ⁽³⁾	348,0	425,0 ⁽²⁾	347,0	406,0 ⁽¹⁾	344,0	393,0 ⁽¹⁾	337,0	346,0 ⁽¹⁾
32	B		316,0 ⁽⁷⁾		311,0 ⁽²⁾	311,0	331,0 ⁽⁶⁾	315,0	328,0 ⁽⁴⁾	315,0	326,0 ⁽³⁾	311,0	319,0 ⁽²⁾	311,0	313,0 ⁽²⁾
	BW		403,0 ⁽²⁾		404,0 ⁽¹⁾	312,0	401,0 ⁽³⁾	316,0	398,0 ⁽²⁾	315,0	387,0 ⁽²⁾	312,0	384,0 ⁽¹⁾	312,0	342,0 ⁽¹⁾
34	B		295,0 ⁽⁸⁾		290,0 ⁽²⁾	268,0	307,0 ⁽⁷⁾	289,0	304,0 ⁽⁵⁾	288,0	302,0 ⁽³⁾	286,0	299,0 ⁽³⁾	286,0	292,0 ⁽²⁾
	BW		374,0 ⁽³⁾		376,0 ⁽¹⁾	268,0	375,0 ⁽⁴⁾	289,0	371,0 ⁽²⁾	287,0	366,0 ⁽²⁾	286,0	367,0 ⁽¹⁾	286,0	336,0 ⁽¹⁾
36	B		274,0 ⁽⁸⁾		272,0 ⁽⁶⁾	221,0	288,0 ⁽⁷⁾	271,0	284,0 ⁽⁵⁾	264,0	281,0 ⁽⁴⁾	263,0	279,0 ⁽³⁾	263,0	274,0 ⁽³⁾
	BW		347,0 ⁽³⁾		348,0 ⁽¹⁾	221,0	350,0 ⁽⁴⁾	271,0	346,0 ⁽³⁾	264,0	345,0 ⁽²⁾	263,0	350,0 ⁽¹⁾	262,0	325,0 ⁽¹⁾
38	B		254,0 ⁽⁸⁾		255,0 ⁽⁶⁾		270,0 ⁽⁸⁾	248,0	265,0 ⁽⁵⁾	244,0	262,0 ⁽⁵⁾	242,0	260,0 ⁽³⁾	243,0	259,0 ⁽³⁾
	BW		317,0 ⁽⁵⁾		322,0 ⁽²⁾		329,0 ⁽⁴⁾	249,0	326,0 ⁽¹⁾	244,0	324,0 ⁽²⁾	242,0	333,0 ⁽¹⁾	242,0	313,0 ⁽¹⁾
40	B		233,0 ⁽⁹⁾		238,0 ⁽⁶⁾		251,0 ⁽⁹⁾	226,0	252,0 ⁽⁷⁾	226,0	248,0 ⁽⁵⁾	225,0	244,0 ⁽⁴⁾	224,0	244,0 ⁽³⁾
	BW		295,0 ⁽⁸⁾		300,0 ⁽²⁾		311,0 ⁽⁵⁾	226,0	308,0 ⁽²⁾	227,0	305,0 ⁽¹⁾	224,0	316,0 ⁽¹⁾	224,0	301,0 ⁽¹⁾
44	B				208,0 ⁽⁹⁾		213,0 ⁽¹⁰⁾		225,0 ⁽⁸⁾	200,0	221,0 ⁽⁶⁾	197,0	217,0 ⁽⁴⁾	194,0	215,0 ⁽³⁾
	BW				257,0 ⁽⁶⁾		278,0 ⁽⁶⁾		277,0 ⁽⁴⁾	200,0	274,0 ⁽²⁾	197,0	282,0 ⁽¹⁾	195,0	278,0 ⁽¹⁾
48	B						187,0 ⁽¹⁰⁾		197,0 ⁽¹⁰⁾	164,0	200,0 ⁽⁸⁾	174,0	196,0 ⁽⁶⁾	170,0	192,0 ⁽⁵⁾
	BW						246,0 ⁽⁷⁾		246,0 ⁽⁴⁾	164,0	247,0 ⁽³⁾	174,0	248,0 ⁽¹⁾	171,0	255,0 ⁽¹⁾
52	B						162,0 ⁽¹⁰⁾		174,0 ⁽¹⁰⁾		177,0 ⁽¹⁰⁾	153,0	173,0 ⁽⁸⁾	154,0	173,0 ⁽⁵⁾
	BW						217,0 ⁽⁸⁾		219,0 ⁽⁵⁾		219,0 ⁽³⁾	153,0	218,0 ⁽²⁾	154,0	232,0 ⁽¹⁾
56	B						137,0 ⁽⁸⁾		152,0 ⁽¹⁰⁾		156,0 ⁽¹⁰⁾		158,0 ⁽⁸⁾	137,0	155,0 ⁽⁶⁾
	BW						190,0 ⁽⁸⁾		198,0 ⁽⁸⁾		197,0 ⁽⁴⁾		192,0 ⁽³⁾	137,0	208,0 ⁽¹⁾
60	B								129,0 ⁽⁸⁾		138,0 ⁽¹⁰⁾		143,0 ⁽⁹⁾	115,0	142,0 ⁽⁷⁾
	BW								179,0 ⁽⁶⁾		177,0 ⁽⁶⁾		175,0 ⁽⁴⁾	115,0	185,0 ⁽¹⁾
64	B								111,0 ⁽⁸⁾		120,0 ⁽¹⁰⁾		129,0 ⁽¹⁰⁾		129,0 ⁽⁷⁾
	BW								156,0 ⁽⁸⁾		163,0 ⁽⁸⁾		161,0 ⁽⁵⁾		162,0 ⁽¹⁾
68	B										103,0 ⁽⁸⁾		113,0 ⁽¹⁰⁾		117,0 ⁽¹⁰⁾
	BW										144,0 ⁽⁸⁾		151,0 ⁽⁷⁾		148,0 ⁽⁵⁾
72	B												96,6 ⁽⁹⁾		106,0 ⁽¹¹⁾
	BW												137,0 ⁽⁸⁾		136,0 ⁽⁵⁾
76	B												81,2 ⁽⁹⁾		94,3 ⁽¹¹⁾
	BW												120,0 ⁽⁸⁾		124,0 ⁽⁸⁾
80	B												67,4 ⁽⁷⁾		79,6 ⁽⁹⁾
	BW												102,0 ⁽⁷⁾		113,0 ⁽⁹⁾
84	B												57,7 ⁽⁷⁾		66,2 ⁽⁹⁾
	BW												89,6 ⁽⁷⁾		100,0 ⁽⁹⁾
88	B														55,7 ⁽⁷⁾
	BW														84,3 ⁽⁷⁾

1) 12° 2) 17° 3) 22° 4) 27° 5) 32° 6) 37° 7) 42° 8) 47° 9) 52° 10) 57° 11) 62°

PDW3B/PDW3BW

P 48

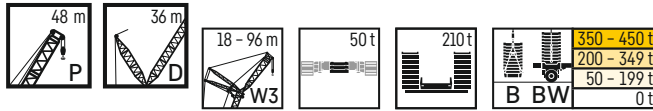

m		P 48 m													
		W3 60		W3 66		W3 72		W3 78		W3 84		W3 90		W3 96	
		87°/85	WVmax	87°/85	WVmax	87°/85	WVmax	87°/85	WVmax	87°/85	WVmax	87°/85	WVmax	87°/85	WVmax
22	B	325,0*	325,0*												
	BW	329,0*	329,0*												
24	B	321,0*	323,0 ⁽¹⁾	292,0*	292,0*										
	BW	324,0*	327,0 ⁽¹⁾	294,0*	294,0*										
26	B	323,0	323,0	287,0*	289,0 ⁽¹⁾	260,0*	260,0*								
	BW	328,0	328,0	291,0*	293,0 ⁽¹⁾	263,0*	263,0*								
28	B	318,0	318,0	288,0	288,0	255,0*	258,0 ⁽¹⁾	231,0*	231,0*	209,0*	209,0*				
	BW	323,0	323,0	293,0	293,0	259,0*	262,0 ⁽¹⁾	234,0*	234,0*	212,0*	212,0*				
30	B	310,0	310,0	283,0	283,0	256,0	256,0	227,0*	227,0*	205,0*	205,0*	188,0*	188,0*		
	BW	316,0	316,0	288,0	288,0	260,0	260,0	230,0*	230,0*	208,0*	208,0*	190,0*	190,0*		
32	B	298,0	299,0 ⁽²⁾	278,0	278,0	252,0	252,0	228,0	228,0	202,0*	202,0*	185,0*	185,0*	167,0*	
	BW	302,0	305,0 ⁽²⁾	283,0	283,0	256,0	256,0	231,0	231,0	205,0*	205,0*	187,0*	187,0*	161,0*	
34	B	281,0	283,0 ⁽²⁾	269,0	269,0	247,0	247,0	225,0	225,0	202,0	202,0	182,0*	182,0*	164,0*	
	BW	282,0	296,0 ⁽²⁾	273,0	274,0 ⁽²⁾	252,0	252,0	228,0	228,0	206,0	206,0	184,0*	184,0*	167,0*	
36	B	260,0	267,0 ⁽²⁾	255,0	256,0 ⁽²⁾	241,0	241,0	221,0	221,0	200,0	200,0	182,0	182,0	162,0*	
	BW	261,0	287,0 ⁽²⁾	257,0	265,0 ⁽²⁾	245,0	245,0	225,0	225,0	203,0	203,0	185,0	185,0	164,0*	
38	B	240,0	253,0 ⁽¹⁾	240,0	245,0 ⁽¹⁾	231,0	232,0 ⁽²⁾	216,0	216,0	197,0	197,0	180,0	180,0	162,0	
	BW	241,0	279,0 ⁽¹⁾	240,0	255,0 ⁽²⁾	233,0	238,0 ⁽²⁾	220,0	220,0	200,0	200,0	182,0	182,0	165,0	
40	B	222,0	241,0 ⁽¹⁾	222,0	237,0 ⁽¹⁾	219,0	222,0 ⁽²⁾	208,0	209,0 ⁽²⁾	194,0	194,0	177,0	177,0	160,0	
	BW	223,0	271,0 ⁽¹⁾	222,0	246,0 ⁽²⁾	220,0	230,0 ⁽²⁾	210,0	213,0 ⁽²⁾	197,0	197,0	180,0	180,0	163,0	
44	B	193,0	217,0 ⁽¹⁾	192,0	219,0 ⁽¹⁾	191,0	203,0 ⁽²⁾	188,0	194,0 ⁽²⁾	182,0	182,0	170,0	170,0	156,0	
	BW	193,0	255,0 ⁽¹⁾	192,0	228,0 ⁽²⁾	191,0	215,0 ⁽²⁾	188,0	200,0 ⁽²⁾	182,0	186,0 ⁽²⁾	172,0	173,0 ⁽²⁾	158,0	
48	B	169,0	193,0 ⁽¹⁾	168,0	202,0 ⁽¹⁾	167,0	183,0 ⁽³⁾	164,0	180,0 ⁽²⁾	163,0	169,0 ⁽²⁾	159,0	160,0 ⁽²⁾	150,0	
	BW	169,0	238,0 ⁽¹⁾	168,0	211,0 ⁽²⁾	167,0	200,0 ⁽²⁾	164,0	188,0 ⁽²⁾	163,0	176,0 ⁽²⁾	159,0	164,0 ⁽²⁾	151,0	
52	B	150,0	171,0 ⁽⁴⁾	148,0	185,0 ⁽¹⁾	147,0	167,0 ⁽¹⁾	144,0	161,0 ⁽²⁾	143,0	156,0 ⁽²⁾	140,0	150,0 ⁽²⁾	139,0	
	BW	150,0	222,0 ⁽¹⁾	148,0	193,0 ⁽²⁾	147,0	184,0 ⁽²⁾	145,0	174,0 ⁽²⁾	143,0	166,0 ⁽²⁾	140,0	155,0 ⁽²⁾	139,0	
56	B	135,0	153,0 ⁽⁵⁾	132,0	168,0 ⁽¹⁾	130,0	151,0 ⁽¹⁾	128,0	145,0 ⁽³⁾	126,0	142,0 ⁽³⁾	124,0	138,0 ⁽²⁾	123,0	
	BW	136,0	206,0 ⁽¹⁾	132,0	181,0 ⁽²⁾	130,0	169,0 ⁽²⁾	128,0	161,0 ⁽²⁾	126,0	154,0 ⁽²⁾	124,0	145,0 ⁽²⁾	123,0	
60	B	121,0	138,0 ⁽⁵⁾	121,0	151,0 ⁽¹⁾	116,0	136,0 ⁽¹⁾	114,0	130,0 ⁽³⁾	112,0	129,0 ⁽³⁾	110,0	124,0 ⁽²⁾	109,0	
	BW	122,0	189,0 ⁽¹⁾	121,0	168,0 ⁽²⁾	116,0	158,0 ⁽²⁾	114,0	148,0 ⁽²⁾	112,0	142,0 ⁽²⁾	110,0	134,0 ⁽²⁾	109,0	
64	B	106,0	125,0 ⁽⁵⁾	108,0	133,0 ⁽¹⁾	107,0	120,0 ⁽¹⁾	102,0	118,0 ⁽⁴⁾	100,0	116,0 ⁽³⁾	98,0	113,0 ⁽³⁾	96,3	
	BW	106,0	173,0 ⁽¹⁾	108,0	156,0 ⁽²⁾	107,0	147,0 ⁽²⁾	102,0	140,0 ⁽²⁾	100,0	133,0 ⁽²⁾	97,6	124,0 ⁽²⁾	96,3	
68	B		115,0 ⁽⁶⁾	96,7	116,0 ⁽¹⁾	96,3	110,0 ⁽⁵⁾	94,8	108,0 ⁽⁴⁾	89,9	105,0 ⁽⁴⁾	87,2	103,0 ⁽³⁾	85,6	
	BW		157,0 ⁽¹⁾	96,6	143,0 ⁽²⁾	96,4	137,0 ⁽²⁾	94,7	131,0 ⁽²⁾	89,9	125,0 ⁽²⁾	87,2	116,0 ⁽²⁾	85,6	
72	B		107,0 ⁽⁹⁾	79,1	105,0 ⁽⁷⁾	86,5	102,0 ⁽⁶⁾	84,9	100,0 ⁽⁵⁾	81,1	96,4 ⁽⁴⁾	78,1	93,7 ⁽³⁾	77,0	
	BW		140,0 ⁽¹⁾	79,0	131,0 ⁽²⁾	86,4	126,0 ⁽²⁾	84,7	122,0 ⁽²⁾	81,2	117,0 ⁽²⁾	78,5	108,0 ⁽²⁾	77,1	
76	B		97,3 ⁽¹¹⁾		97,3 ⁽⁸⁾	75,2	93,6 ⁽⁶⁾	76,9	92,4 ⁽⁵⁾	75,5	88,2 ⁽⁴⁾	69,8	85,5 ⁽³⁾	68,2	
	BW		124,0 ⁽⁴⁾		119,0 ⁽³⁾	75,3	115,0 ⁽⁵⁾	76,9	113,0 ⁽²⁾	75,5	109,0 ⁽²⁾	69,8	101,0 ⁽²⁾	68,2	
80	B		85,0 ⁽¹¹⁾		87,7 ⁽⁹⁾		84,5 ⁽⁷⁾	68,7	83,5 ⁽⁵⁾	67,6	80,1 ⁽⁴⁾	64,2	77,3 ⁽³⁾	61,3	
	BW		110,0 ⁽⁷⁾		108,0 ⁽⁴⁾		106,0 ⁽³⁾	68,6	104,0 ⁽²⁾	67,6	101,0 ⁽²⁾	64,2	93,8 ⁽²⁾	61,2	
84	B		71,7 ⁽⁹⁾		77,8 ⁽¹¹⁾		78,3 ⁽¹⁰⁾	55,2	76,0 ⁽⁷⁾	60,8	74,1 ⁽⁶⁾	58,8	71,0 ⁽⁵⁾	56,4	
	BW		101,0 ⁽⁸⁾		97,5 ⁽⁴⁾		96,3 ⁽⁴⁾	55,3	94,1 ⁽²⁾	60,8	92,5 ⁽²⁾	58,9	86,5 ⁽²⁾	56,2	
88	B		62,5 ⁽⁹⁾		69,1 ⁽¹¹⁾		71,7 ⁽¹¹⁾		70,4 ⁽⁸⁾	52,6	68,0 ⁽⁴⁾	52,9	65,1 ⁽⁵⁾	51,4	
	BW		92,4 ⁽⁹⁾		90,5 ⁽⁸⁾		87,8 ⁽⁴⁾		85,7 ⁽³⁾	52,8	84,4 ⁽²⁾	53,0	80,0 ⁽²⁾	51,2	
92	B		52,1 ⁽⁷⁾		59,5 ⁽⁹⁾		64,4 ⁽¹¹⁾		64,6 ⁽⁹⁾		61,8 ⁽⁶⁾	46,1	59,1 ⁽⁵⁾	45,1	
	BW		80,5 ⁽⁷⁾		82,4 ⁽⁸⁾		80,2 ⁽⁷⁾		77,9 ⁽⁴⁾		76,3 ⁽²⁾	47,5	73,9 ⁽²⁾	44,9	
96	B		44,0 ⁽⁷⁾		49,7 ⁽⁷⁾		55,5 ⁽⁹⁾		58,8 ⁽⁹⁾		56,6 ⁽⁹⁾	36,3	53,7 ⁽⁴⁾	40,5	
	BW		67,8 ⁽⁷⁾		73,8 ⁽⁷⁾		74,0 ⁽⁸⁾		71,8 ⁽⁵⁾		70,0 ⁽³⁾	36,3	67,8 ⁽²⁾	40,2	
100	B				42,2 ⁽⁷⁾		47,5 ⁽⁹⁾		53,8 ⁽¹¹⁾		51,9 ⁽⁹⁾		49,3 ⁽⁸⁾	34,0	
	BW				64,6 ⁽⁷⁾		68,2 ⁽⁶⁾		66,5 ⁽⁵⁾		64,5 ⁽⁴⁾		62,5 ⁽³⁾	34,1	
104	B						38,7 ⁽⁷⁾		45,6 ⁽⁹⁾		47,5 ⁽¹⁰⁾		45,7 ⁽⁸⁾	34,3 ⁽⁶⁾	
	BW						60,5 ⁽⁷⁾		62,0 ⁽⁴⁾		59,7 ⁽⁵⁾		58,0 ⁽³⁾	55,8 ⁽²⁾	
108	B						32,5 ⁽⁷⁾		36,8 ⁽⁷⁾		41,8 ⁽⁹⁾		42,4 ⁽⁹⁾	39,9 ⁽⁷⁾	
	BW						52,8 ⁽⁷⁾		57,7 ⁽⁷⁾		56,1 ⁽⁵⁾		54,2 ⁽⁴⁾	51,3 ⁽³⁾	
112	B								30,8 ⁽⁷⁾		35,5 ⁽⁹⁾		39,2 ⁽¹⁰⁾	36,8 ⁽⁸⁾	
	BW								49,9 ⁽⁷⁾		52,8 ⁽⁷⁾		50,6 ⁽⁴⁾	47,6 ⁽⁵⁾	
116	B										28,1 ⁽⁷⁾		33,3 ⁽⁹⁾	34,3 ⁽⁹⁾	
	BW										47,2 ⁽⁷⁾		46,0 ⁽⁵⁾	42,9 ⁽⁵⁾	
120	B										22,2 ⁽⁷⁾		25,9 ⁽⁷⁾	30,0 ⁽⁹⁾	
	BW										40,0 ⁽⁷⁾		40,9 ⁽⁷⁾	38,9 ⁽⁵⁾	
124	B												20,3 ⁽⁷⁾	24,2 ⁽⁹⁾	
	BW												36,2 ⁽⁷⁾	35,3 ⁽⁶⁾	
128	B													17,5 ⁽⁷⁾	
	BW													32,0 ⁽⁷⁾	
132	B													12,9 ⁽⁷⁾	
	BW													28,5 ⁽⁷⁾	

1) 12° 2) 17° 3) 22° 4) 27° 5) 32° 6) 37° 7) 42° 8) 47° 9) 52° 10) 57° 11) 62°

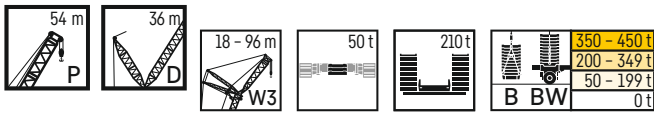

m	B BW	P 54 m													
		W3 18 m		W3 24 m		W3 30 m		W3 36 m		W3 42 m		W3 48 m		W3 54 m	
		87°/85	WVmax	87°/85	WVmax	87°/85	WVmax	87°/85	WVmax	87°/85	WVmax	87°/85	WVmax	87°/85	WVmax
12	B	650,0*	650,0*												
	BW	650,0*	650,0*												
14	B	649,0*	650,0 ⁽¹⁾	614,0*	614,0*										
	BW	650,0*	650,0*	620,0*	620,0*										
16	B	638,0	638,0	585,0*	587,0 ⁽¹⁾	560,0*	560,0*								
	BW	646,0	646,0	589,0*	595,0 ⁽¹⁾	565,0*	565,0*								
18	B	556,0	587,0 ⁽²⁾	572,0	572,0	555,0	555,0	490,0*	495,0 ⁽¹⁾	442,0*	442,0*				
	BW	558,0	628,0 ⁽¹⁾	598,0	598,0	571,0	571,0	496,0*	502,0 ⁽¹⁾	447,0*	447,0*				
20	B	461,0	534,0 ⁽²⁾	507,0	527,0 ⁽²⁾	521,0	521,0	495,0	495,0	434,0*	441,0 ⁽¹⁾	392,0*	392,0*		
	BW	460,0	615,0 ⁽¹⁾	507,0	566,0 ⁽²⁾	554,0	554,0	503,0	503,0	438,0*	446,0 ⁽¹⁾	397,0*	397,0*		
22	B	390,0	483,0 ⁽³⁾	428,0	497,0 ⁽¹⁾	480,0	483,0 ⁽²⁾	470,0	470,0	440,0	440,0	385,0*	392,0 ⁽¹⁾	350,0*	
	BW	390,0	584,0 ⁽¹⁾	430,0	537,0 ⁽²⁾	519,0	530,0 ⁽¹⁾	494,0	494,0	445,0	445,0	390,0*	397,0 ⁽¹⁾	353,0*	
24	B	320,0	441,0 ⁽²⁾	371,0	468,0 ⁽¹⁾	442,0	445,0 ⁽²⁾	435,0	437,0 ⁽²⁾	425,0	425,0	391,0	391,0	345,0*	
	BW	321,0	538,0 ⁽¹⁾	371,0	509,0 ⁽²⁾	484,0	509,0 ⁽¹⁾	485,0	485,0	438,0	438,0	396,0	396,0	348,0*	
26	B		407,0 ⁽⁴⁾	326,0	439,0 ⁽¹⁾	409,0	410,0 ⁽³⁾	404,0	405,0 ⁽²⁾	398,0	399,0 ⁽²⁾	382,0	382,0	348,0	
	BW		495,0 ⁽²⁾	326,0	480,0 ⁽²⁾	445,0	485,0 ⁽¹⁾	446,0	463,0 ⁽¹⁾	425,0	426,0 ⁽²⁾	391,0	392,0 ⁽¹⁾	355,0	
28	B		376,0 ⁽⁵⁾	295,0	410,0 ⁽¹⁾	380,0	381,0 ⁽⁴⁾	375,0	377,0 ⁽³⁾	371,0	373,0 ⁽²⁾	364,0	365,0 ⁽²⁾	342,0	
	BW		455,0 ⁽¹⁾	296,0	450,0 ⁽²⁾	397,0	453,0 ⁽²⁾	400,0	447,0 ⁽¹⁾	399,0	413,0 ⁽¹⁾	379,0	388,0 ⁽¹⁾	349,0	
30	B		346,0 ⁽⁵⁾	252,0	381,0 ⁽¹⁾	355,0	355,0	350,0	351,0 ⁽⁴⁾	347,0	347,0	341,0	342,0 ⁽²⁾	331,0	
	BW		427,0 ⁽¹⁾	252,0	425,0 ⁽¹⁾	358,0	424,0 ⁽²⁾	360,0	419,0 ⁽¹⁾	358,0	402,0 ⁽¹⁾	357,0	384,0 ⁽¹⁾	338,0	
32	B		319,0 ⁽⁵⁾		352,0 ⁽¹⁾	325,0	331,0 ⁽⁶⁾	324,0	327,0 ⁽⁵⁾	324,0	325,0 ⁽⁴⁾	320,0	321,0 ⁽⁵⁾	314,0	
	BW		400,0 ⁽¹⁾		401,0 ⁽¹⁾	325,0	396,0 ⁽³⁾	326,0	393,0 ⁽²⁾	324,0	382,0 ⁽²⁾	325,0	380,0 ⁽¹⁾	331,0	
34	B		299,0 ⁽⁸⁾		323,0 ⁽¹⁾	283,0	309,0 ⁽⁷⁾	296,0	306,0 ⁽⁵⁾	298,0	306,0 ⁽⁴⁾	296,0	301,0 ⁽⁵⁾	294,0	
	BW		374,0 ⁽⁵⁾		376,0 ⁽¹⁾	282,0	372,0 ⁽⁴⁾	297,0	368,0 ⁽³⁾	296,0	365,0 ⁽²⁾	297,0	367,0 ⁽¹⁾	297,0	
36	B		279,0 ⁽⁸⁾		294,0 ⁽¹⁾	236,0	288,0 ⁽⁷⁾	276,0	285,0 ⁽⁵⁾	273,0	286,0 ⁽⁴⁾	271,0	282,0 ⁽⁵⁾	272,0	
	BW		349,0 ⁽⁵⁾		352,0 ⁽¹⁾	236,0	349,0 ⁽⁵⁾	278,0	346,0 ⁽³⁾	272,0	344,0 ⁽²⁾	272,0	354,0 ⁽¹⁾	272,0	
38	B		259,0 ⁽⁸⁾		265,0 ⁽¹⁾		269,0 ⁽⁸⁾	257,0	267,0 ⁽⁶⁾	253,0	266,0 ⁽⁴⁾	250,0	263,0 ⁽⁵⁾	251,0	
	BW		326,0 ⁽⁴⁾		328,0 ⁽¹⁾		328,0 ⁽⁵⁾	257,0	325,0 ⁽³⁾	251,0	323,0 ⁽²⁾	250,0	341,0 ⁽¹⁾	251,0	
40	B		240,0 ⁽⁸⁾		247,0 ⁽⁹⁾		254,0 ⁽⁹⁾	236,0	251,0 ⁽⁶⁾	234,0	251,0 ⁽⁵⁾	231,0	248,0 ⁽⁴⁾	232,0	
	BW		304,0 ⁽⁴⁾		308,0 ⁽³⁾		307,0 ⁽²⁾	235,0	305,0 ⁽⁴⁾	233,0	302,0 ⁽²⁾	232,0	327,0 ⁽¹⁾	233,0	
44	B				216,0 ⁽⁹⁾		221,0 ⁽⁹⁾		225,0 ⁽⁸⁾	206,0	224,0 ⁽⁶⁾	202,0	220,0 ⁽⁵⁾	201,0	
	BW				269,0 ⁽⁴⁾		276,0 ⁽⁷⁾		274,0 ⁽³⁾	206,0	271,0 ⁽¹⁾	202,0	300,0 ⁽¹⁾	201,0	
48	B				184,0 ⁽¹⁰⁾		195,0 ⁽¹⁰⁾		201,0 ⁽¹⁰⁾	174,0	202,0 ⁽⁸⁾	179,0	199,0 ⁽⁶⁾	176,0	
	BW				238,0 ⁽⁸⁾		250,0 ⁽⁸⁾		248,0 ⁽⁵⁾	173,0	246,0 ⁽⁴⁾	180,0	274,0 ⁽¹⁾	176,0	
52	B						171,0 ⁽¹⁰⁾		176,0 ⁽⁹⁾		183,0 ⁽¹⁰⁾	158,0	179,0 ⁽⁷⁾	158,0	
	BW						223,0 ⁽⁸⁾		224,0 ⁽⁴⁾		223,0 ⁽⁴⁾	158,0	247,0 ⁽¹⁾	158,0	
56	B						145,0 ⁽⁸⁾		154,0 ⁽⁹⁾		163,0 ⁽¹¹⁾		164,0 ⁽⁸⁾	141,0	
	BW						197,0 ⁽⁸⁾		201,0 ⁽⁷⁾		201,0 ⁽⁵⁾		220,0 ⁽¹⁾	205,0 ⁽¹⁾	
60	B						125,0 ⁽⁸⁾		133,0 ⁽¹⁰⁾		144,0 ⁽¹⁰⁾		147,0 ⁽⁹⁾	121,0	
	BW						175,0 ⁽⁸⁾		182,0 ⁽⁹⁾		182,0 ⁽⁵⁾		193,0 ⁽¹⁾	185,0 ⁽¹⁾	
64	B								115,0 ⁽⁶⁾		127,0 ⁽¹⁰⁾		132,0 ⁽⁹⁾	132,0 ⁽⁹⁾	
	BW								163,0 ⁽⁸⁾		166,0 ⁽⁷⁾		166,0 ⁽¹⁾	166,0 ⁽¹⁾	
68	B								99,5 ⁽⁸⁾		106,0 ⁽⁸⁾		117,0 ⁽⁹⁾	121,0 ⁽¹⁰⁾	
	BW								144,0 ⁽⁸⁾		151,0 ⁽⁸⁾		150,0 ⁽⁴⁾	150,0 ⁽⁴⁾	
72	B										91,9 ⁽⁶⁾		103,0 ⁽¹⁰⁾	109,0 ⁽¹¹⁾	
	BW										133,0 ⁽⁸⁾		140,0 ⁽⁸⁾	137,0 ⁽⁵⁾	
76	B												88,4 ⁽⁹⁾	95,1 ⁽¹¹⁾	
	BW												126,0 ⁽⁸⁾	129,0 ⁽⁷⁾	
80	B												74,1 ⁽⁹⁾	81,7 ⁽⁷⁾	
	BW												111,0 ⁽⁸⁾	120,0 ⁽⁹⁾	
84	B												61,2 ⁽⁷⁾	70,2 ⁽⁷⁾	
	BW												94,7 ⁽⁷⁾	107,0 ⁽⁹⁾	
88	B												52,8 ⁽⁷⁾	59,1 ⁽⁷⁾	
	BW												80,1 ⁽⁷⁾	91,5 ⁽⁷⁾	
92	B													50,6 ⁽⁷⁾	
	BW													78,2 ⁽⁷⁾	

1) 12° 2) 17° 3) 22° 4) 27° 5) 32° 6) 37° 7) 42° 8) 47° 9) 52° 10) 57° 11) 62°

PDW3B/PDW3BW

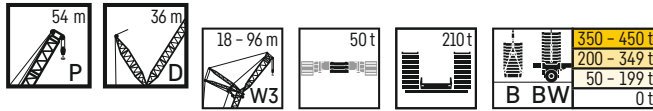

m		P 54 m													
		W3 60		W3 66		W3 72		W3 78		W3 84		W3 90		W3 96	
		87°/85	WVmax	87°/85	WVmax	87°/85	WVmax	87°/85	WVmax	87°/85	WVmax	87°/85	WVmax	87°/85	WVmax
24	B	313,0*	313,0*	284,0*	284,0*										
	BW	315,0*	315,0*	287,0*	287,0*										
26	B	307,0*	313,0 ¹⁾	279,0*	281,0 ¹⁾	253,0*	253,0*								
	BW	311,0*	317,0 ¹⁾	283,0*	285,0 ¹⁾	256,0*	256,0*								
28	B	310,0	310,0	281,0	281,0	248,0*	251,0 ¹⁾	225,0*	225,0*						
	BW	315,0	315,0	286,0	286,0	252,0*	254,0 ¹⁾	228,0*	228,0*						
30	B	304,0	304,0	276,0	276,0	249,0	249,0	222,0*	222,0*	200,0*	200,0*	182,0*	182,0*		
	BW	310,0	310,0	281,0	281,0	254,0	254,0	224,0*	224,0*	203,0*	203,0*	185,0*	185,0*		
32	B	297,0	297,0	271,0	271,0	245,0	245,0	218,0*	218,0*	197,0*	197,0*	180,0*	180,0*	156,0*	156,0*
	BW	301,0	302,0 ²⁾	277,0	277,0	250,0	250,0	220,0*	220,0*	200,0*	200,0*	182,0*	182,0*	157,0*	157,0*
34	B	287,0	287,0	265,0	265,0	241,0	241,0	220,0	220,0	194,0*	194,0*	178,0*	178,0*	160,0*	160,0*
	BW	287,0	293,0 ²⁾	270,0	270,0	246,0	246,0	223,0	223,0	196,0*	196,0*	179,0*	179,0*	162,0*	162,0*
36	B	270,0	270,0	256,0	256,0	237,0	237,0	217,0	217,0	195,0	195,0	175,0*	175,0*	157,0*	157,0*
	BW	269,0	285,0 ²⁾	260,0	263,0 ²⁾	242,0	242,0	219,0	219,0	198,0	198,0	177,0*	177,0*	160,0*	160,0*
38	B	249,0	261,0 ¹⁾	245,0	245,0	232,0	232,0	213,0	213,0	193,0	193,0	176,0	176,0	158,0	158,0
	BW	248,0	276,0 ²⁾	246,0	256,0 ²⁾	234,0	235,0 ²⁾	215,0	215,0	196,0	196,0	178,0	178,0	161,0	161,0
40	B	231,0	251,0 ¹⁾	229,0	234,0 ¹⁾	223,0	223,0	209,0	209,0	190,0	190,0	174,0	174,0	156,0	156,0
	BW	229,0	268,0 ²⁾	228,0	249,0 ²⁾	224,0	229,0 ²⁾	210,0	211,0 ²⁾	193,0	193,0	176,0	176,0	159,0	159,0
44	B	200,0	232,0 ¹⁾	197,0	218,0 ¹⁾	196,0	205,0 ²⁾	195,0	195,0	183,0	183,0	169,0	169,0	152,0	152,0
	BW	198,0	252,0 ¹⁾	197,0	235,0 ²⁾	196,0	218,0 ²⁾	193,0	201,0 ²⁾	185,0	185,0	171,0	171,0	155,0	155,0
48	B	175,0	213,0 ¹⁾	172,0	202,0 ¹⁾	171,0	187,0 ²⁾	171,0	180,0 ²⁾	167,0	171,0 ²⁾	163,0	163,0	148,0	148,0
	BW	173,0	237,0 ¹⁾	173,0	218,0 ²⁾	171,0	206,0 ²⁾	169,0	192,0 ²⁾	168,0	177,0 ²⁾	162,0	164,0 ²⁾	151,0	151,0
52	B	154,0	195,0 ¹⁾	152,0	186,0 ¹⁾	151,0	170,0 ³⁾	150,0	165,0 ³⁾	147,0	162,0 ²⁾	146,0	153,0 ²⁾	141,0	141,0
	BW	153,0	222,0 ¹⁾	152,0	201,0 ²⁾	151,0	191,0 ²⁾	149,0	180,0 ²⁾	147,0	169,0 ²⁾	145,0	157,0 ²⁾	143,0	145,0 ²⁾
56	B	140,0	176,0 ¹⁾	135,0	170,0 ¹⁾	133,0	152,0 ³⁾	133,0	151,0 ³⁾	130,0	146,0 ²⁾	129,0	144,0 ²⁾	125,0	134,0 ²⁾
	BW	139,0	207,0 ¹⁾	135,0	186,0 ²⁾	134,0	176,0 ²⁾	131,0	167,0 ²⁾	130,0	159,0 ²⁾	127,0	149,0 ²⁾	126,0	140,0 ²⁾
60	B	125,0	157,0 ¹⁾	124,0	154,0 ¹⁾	120,0	138,0 ⁴⁾	118,0	135,0 ³⁾	115,0	134,0 ³⁾	115,0	129,0 ²⁾	111,0	125,0 ²⁾
	BW	124,0	191,0 ¹⁾	124,0	172,0 ²⁾	119,0	164,0 ²⁾	117,0	154,0 ²⁾	115,0	147,0 ²⁾	112,0	139,0 ²⁾	111,0	133,0 ²⁾
64	B	110,0	138,0 ¹⁾	111,0	138,0 ¹⁾	109,0	124,0 ⁴⁾	106,0	123,0 ⁴⁾	103,0	121,0 ³⁾	102,0	117,0 ³⁾	98,8	113,0 ²⁾
	BW	109,0	176,0 ¹⁾	111,0	158,0 ²⁾	110,0	153,0 ²⁾	105,0	145,0 ²⁾	103,0	137,0 ²⁾	101,0	129,0 ²⁾	98,9	123,0 ²⁾
68	B		119,0 ¹⁾	98,7	122,0 ¹⁾	98,7	114,0 ⁵⁾	97,7	112,0 ⁴⁾	92,3	108,0 ⁴⁾	90,7	107,0 ³⁾	87,9	103,0 ³⁾
	BW		161,0 ¹⁾	99,1	144,0 ²⁾	98,8	142,0 ²⁾	96,6	136,0 ²⁾	92,2	129,0 ²⁾	89,7	120,0 ²⁾	88,0	114,0 ²⁾
72	B		110,0 ⁹⁾	82,7	108,0 ⁷⁾	88,4	105,0 ⁶⁾	88,0	103,0 ⁵⁾	83,2	99,5 ⁴⁾	81,8	96,7 ³⁾	79,0	92,9 ³⁾
	BW		146,0 ¹⁾	83,1	133,0 ⁵⁾	88,0	130,0 ²⁾	86,7	127,0 ²⁾	83,0	121,0 ²⁾	80,6	113,0 ²⁾	78,9	106,0 ²⁾
76	B		103,0 ¹¹⁾		102,0 ⁸⁾	78,4	97,6 ⁶⁾	79,7	96,3 ⁵⁾	76,8	91,0 ⁴⁾	73,9	88,1 ³⁾	70,3	83,8 ²⁾
	BW		131,0 ¹⁾		123,0 ⁵⁾	78,3	120,0 ⁵⁾	78,3	118,0 ²⁾	76,8	113,0 ²⁾	71,7	106,0 ²⁾	70,3	100,0 ²⁾
80	B		91,1 ¹¹⁾		92,2 ⁹⁾		91,3 ⁷⁾	71,3	87,3 ⁵⁾	69,0	82,9 ⁴⁾	66,8	80,1 ³⁾	63,0	77,5 ⁴⁾
	BW		116,0 ⁴⁾		114,0 ⁴⁾		112,0 ⁵⁾	70,3	109,0 ²⁾	69,2	105,0 ²⁾	65,3	98,8 ²⁾	63,1	94,0 ²⁾
84	B		78,7 ¹¹⁾		82,1 ⁹⁾		82,4 ⁸⁾	59,2	79,2 ⁷⁾	62,0	76,5 ⁴⁾	61,3	74,3 ³⁾	57,7	71,3 ⁴⁾
	BW		107,0 ⁸⁾		104,0 ⁵⁾		102,0 ⁴⁾	58,5	99,1 ¹³⁾	62,1	97,4 ²⁾	60,1	91,8 ²⁾	57,6	87,8 ²⁾
88	B		66,5 ⁹⁾		72,7 ¹¹⁾		75,5 ¹¹⁾		74,0 ⁸⁾	54,6	70,4 ⁴⁾	55,6	68,1 ⁵⁾	52,9	64,9 ⁵⁾
	BW		95,8 ⁹⁾		96,0 ⁷⁾		92,5 ⁵⁾		90,9 ³⁾	54,7	89,0 ²⁾	54,4	84,9 ²⁾	52,7	81,5 ²⁾
92	B		57,5 ⁹⁾		62,4 ⁹⁾		68,1 ¹¹⁾		68,1 ⁹⁾		64,0 ⁴⁾	50,1	61,9 ⁴⁾	46,4	59,5 ⁵⁾
	BW		84,2 ⁹⁾		87,4 ⁸⁾		84,5 ⁵⁾		82,6 ⁴⁾		80,7 ²⁾	48,8	78,3 ²⁾	46,5	75,3 ²⁾
96	B		47,7 ⁷⁾		54,0 ⁹⁾		60,7 ¹¹⁾		61,9 ⁹⁾		58,9 ⁹⁾	38,9	56,4 ⁴⁾	41,3	53,8 ⁵⁾
	BW		72,2 ⁷⁾		78,5 ⁹⁾		78,0 ⁸⁾		75,6 ⁴⁾		73,8 ³⁾	38,6	71,6 ²⁾	41,6	69,7 ²⁾
100	B		40,1 ⁷⁾		44,4 ⁷⁾		51,2 ⁹⁾		55,9 ¹¹⁾		53,9 ¹⁰⁾		52,0 ⁸⁾	35,5	48,2 ⁷⁾
	BW		62,9 ⁷⁾		68,5 ⁷⁾		71,7 ⁸⁾		69,5 ⁶⁾		67,6 ⁴⁾		65,2 ³⁾	35,5	64,1 ²⁾
104	B				38,0 ⁷⁾		43,6 ⁹⁾		49,0 ⁹⁾		49,1 ¹⁰⁾		47,6 ⁹⁾		43,9 ⁷⁾
	BW				60,3 ⁷⁾		65,4 ⁹⁾		64,5 ⁷⁾		62,2 ⁴⁾		60,2 ³⁾		58,5 ²⁾
108	B						35,3 ⁷⁾		41,8 ⁹⁾		44,4 ¹¹⁾		43,1 ⁹⁾		39,7 ⁸⁾
	BW						56,5 ⁷⁾		60,0 ⁸⁾		57,7 ⁵⁾		55,2 ³⁾		52,9 ²⁾
112	B						29,3 ⁷⁾		33,1 ⁷⁾		37,8 ⁹⁾		38,6 ⁹⁾		35,7 ⁸⁾
	BW						48,2 ⁷⁾		54,5 ⁷⁾		53,5 ⁴⁾		51,3 ⁴⁾		48,0 ³⁾
116	B								27,0 ⁷⁾		31,7 ⁹⁾		33,6 ⁹⁾		32,1 ¹⁰⁾
	BW								46,8 ⁷⁾		50,4 ⁷⁾		46,9 ⁴⁾		44,4 ⁴⁾
120	B										24,5 ⁷⁾		27,9 ⁹⁾		28,9 ¹¹⁾
	BW										44,2 ⁷⁾		43,6 ⁴⁾		41,2 ⁵⁾
124	B										19,1 ⁷⁾		20,9 ⁷⁾		23,3 ⁹⁾
	BW										37,2 ⁷⁾		40,0 ⁷⁾		38,2 ⁵⁾
128	B												16,0 ⁷⁾		18,1 ⁹⁾
	BW												34,2 ⁷⁾		35,2 ⁷⁾
132	B														11,7 ⁷⁾
	BW														30,6 ⁷⁾
136	B														7,1 ⁷⁾
	BW														25,7 ⁷⁾

1) 12° 2) 17° 3) 22° 4) 27° 5) 32° 6) 37° 7) 42° 8) 47° 9) 52° 10) 57° 11) 62°

PDW3B/PDW3BW

P 60

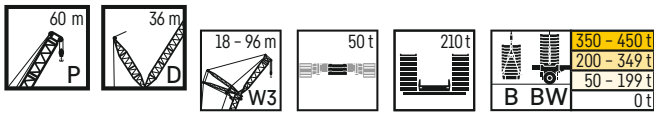

m	B BW	P 60 m													
		W3 18 m		W3 24 m		W3 30 m		W3 36 m		W3 42 m		W3 48 m		W3 54 m	
		87°/85	WVmax	87°/85	WVmax	87°/85	WVmax	87°/85	WVmax	87°/85	WVmax	87°/85	WVmax	87°/85	WVmax
14	B	647,0*	647,0*	599,0*	599,0*										
	BW	650,0*	650,0*												
16	B	619,0	619,0	577,0*	577,0*	536,0*	536,0*								
	BW	650,0	650,0	582,0*	582,0*	545,0*	545,0*								
18	B	572,0	574,0 ⁽²⁾	556,0	556,0	514,0*	530,0 ⁽¹⁾	476,0*	476,0*	431,0*	431,0*				
	BW	591,0	625,0 ⁽²⁾	592,0	592,0	523,0*	552,0 ⁽¹⁾	481,0*	481,0*	436,0*	436,0*				
20	B	482,0	526,0 ⁽³⁾	517,0	520,0 ⁽¹⁾	507,0	507,0	482,0	482,0	421,0*	428,0 ⁽¹⁾	382,0*	382,0*		
	BW	482,0	597,0 ⁽¹⁾	532,0	563,0 ⁽²⁾	543,0	543,0	486,0	486,0	427,0*	433,0 ⁽¹⁾	385,0*	385,0*		
22	B	406,0	482,0 ⁽³⁾	450,0	494,0 ⁽¹⁾	471,0	473,0 ⁽²⁾	459,0	459,0	430,0	430,0	375,0*	381,0 ⁽¹⁾	340,0*	340,0*
	BW	407,0	574,0 ⁽¹⁾	449,0	536,0 ⁽²⁾	520,0	520,0	481,0	481,0	436,0	436,0	379,0*	386,0 ⁽¹⁾	344,0*	344,0*
24	B	344,0	437,0 ⁽³⁾	386,0	467,0 ⁽¹⁾	436,0	438,0 ⁽²⁾	429,0	429,0	417,0	417,0	382,0	382,0	335,0*	341,0 ⁽¹⁾
	BW	344,0	532,0 ⁽²⁾	387,0	509,0 ⁽²⁾	484,0	498,0 ⁽¹⁾	469,0	469,0	429,0	429,0	387,0	387,0	339,0*	346,0 ⁽¹⁾
26	B	254,0	402,0 ⁽³⁾	337,0	441,0 ⁽¹⁾	404,0	406,0 ⁽³⁾	398,0	400,0 ⁽²⁾	392,0	392,0	374,0	374,0	341,0	341,0
	BW	254,0	493,0 ⁽²⁾	337,0	482,0 ⁽²⁾	447,0	477,0 ⁽¹⁾	452,0	452,0	419,0	419,0	381,0	382,0 ⁽¹⁾	346,0	346,0
28	B		372,0 ⁽⁵⁾	305,0	415,0 ⁽¹⁾	375,0	377,0 ⁽⁴⁾	372,0*	372,0*	365,0	367,0 ⁽²⁾	359,0	359,0	334,0	334,0
	BW		454,0 ⁽²⁾	305,0	451,0 ⁽²⁾	410,0	449,0 ⁽¹⁾	424,0	435,0 ⁽¹⁾	405,0	409,0 ⁽¹⁾	374,0	376,0 ⁽¹⁾	341,0	341,0
30	B		346,0 ⁽⁶⁾	266,0	388,0 ⁽¹⁾	350,0	351,0 ⁽⁵⁾	346,0	347,0 ⁽⁵⁾	342,0	343,0 ⁽³⁾	336,0	337,0 ⁽²⁾	325,0	325,0
	BW		419,0 ⁽³⁾	267,0	420,0 ⁽²⁾	368,0	419,0 ⁽²⁾	385,0	414,0 ⁽¹⁾	382,0	399,0 ⁽¹⁾	365,0	371,0 ⁽¹⁾	334,0	334,0
32	B		321,0 ⁽⁷⁾	203,0	362,0 ⁽¹⁾	326,0	328,0 ⁽⁶⁾	324,0	325,0 ⁽⁵⁾	321,0	322,0 ⁽³⁾	316,0	316,0	310,0	310,0
	BW		384,0 ⁽⁵⁾	203,0	388,0 ⁽²⁾	329,0	392,0 ⁽³⁾	349,0	388,0 ⁽¹⁾	348,0	383,0 ⁽¹⁾	342,0	366,0 ⁽¹⁾	326,0	327,0 ⁽²⁾
34	B		296,0 ⁽⁸⁾		335,0 ⁽¹⁾	286,0	307,0 ⁽⁷⁾	305,0	305,0	302,0	302,0	297,0	298,0 ⁽³⁾	294,0	294,0
	BW		328,0 ⁽⁸⁾		363,0 ⁽²⁾	287,0	368,0 ⁽⁴⁾	319,0	364,0 ⁽²⁾	318,0	361,0 ⁽¹⁾	316,0	356,0 ⁽¹⁾	311,0	320,0 ⁽²⁾
36	B				309,0 ⁽¹⁾	241,0	286,0 ⁽⁷⁾	288,0	288,0	284,0	284,0	280,0	280,0	278,0	279,0 ⁽¹⁾
	BW				344,0 ⁽²⁾	241,0	347,0 ⁽⁵⁾	296,0	344,0 ⁽³⁾	292,0	340,0 ⁽²⁾	290,0	342,0 ⁽¹⁾	289,0	313,0 ⁽²⁾
38	B				283,0 ⁽¹⁾	187,0	266,0 ⁽⁸⁾	271,0	272,0 ⁽⁸⁾	267,0	268,0 ⁽⁵⁾	265,0	265,0	262,0	266,0 ⁽¹⁾
	BW				324,0 ⁽²⁾	187,0	328,0 ⁽⁶⁾	274,0	325,0 ⁽⁴⁾	269,0	321,0 ⁽³⁾	267,0	327,0 ⁽¹⁾	267,0	306,0 ⁽²⁾
40	B				256,0 ⁽¹⁾		250,0 ⁽⁸⁾	241,0	256,0 ⁽⁸⁾	248,0	253,0 ⁽⁶⁾	248,0	250,0 ⁽⁵⁾	246,0	254,0 ⁽¹⁾
	BW				306,0 ⁽³⁾		309,0 ⁽⁶⁾	242,0	307,0 ⁽⁵⁾	249,0	304,0 ⁽³⁾	247,0	312,0 ⁽¹⁾	247,0	297,0 ⁽²⁾
44	B				218,0 ⁽¹⁰⁾		222,0 ⁽⁹⁾	160,0	225,0 ⁽⁸⁾	218,0	224,0 ⁽⁷⁾	214,0	222,0 ⁽⁵⁾	213,0	229,0 ⁽¹⁾
	BW				272,0 ⁽⁴⁾		273,0 ⁽⁷⁾	160,0	274,0 ⁽⁵⁾	219,0	273,0 ⁽⁴⁾	214,0	283,0 ⁽⁶⁾	214,0	268,0 ⁽²⁾
48	B				192,0 ⁽¹⁰⁾		196,0 ⁽¹⁰⁾		202,0 ⁽¹⁰⁾	176,0	201,0 ⁽⁸⁾	190,0	198,0 ⁽⁶⁾	187,0	204,0 ⁽¹⁾
	BW				240,0 ⁽⁵⁾		247,0 ⁽⁸⁾		244,0 ⁽⁴⁾	177,0	243,0 ⁽⁵⁾	191,0	254,0 ⁽¹⁾	187,0	245,0 ⁽¹⁾
52	B						175,0 ⁽¹⁰⁾		179,0 ⁽¹⁰⁾		182,0 ⁽⁹⁾	161,0	179,0 ⁽⁷⁾	167,0	180,0 ⁽¹⁾
	BW						222,0 ⁽⁸⁾		224,0 ⁽⁸⁾		221,0 ⁽⁵⁾	161,0	224,0 ⁽¹⁾	168,0	227,0 ⁽¹⁾
56	B						154,0 ⁽¹⁰⁾		158,0 ⁽¹⁰⁾		165,0 ⁽¹⁰⁾	120,0	164,0 ⁽⁹⁾	148,0	162,0 ⁽⁷⁾
	BW						198,0 ⁽⁹⁾		203,0 ⁽⁸⁾		204,0 ⁽⁷⁾	120,0	200,0 ⁽⁵⁾	148,0	209,0 ⁽¹⁾
60	B								140,0 ⁽¹⁰⁾		146,0 ⁽¹⁰⁾		149,0 ⁽¹⁰⁾	122,0	150,0 ⁽⁸⁾
	BW								183,0 ⁽⁹⁾		186,0 ⁽⁸⁾		183,0 ⁽⁵⁾	122,0	190,0 ⁽¹⁾
64	B								118,0 ⁽⁸⁾		131,0 ⁽¹⁰⁾		134,0 ⁽¹⁰⁾		137,0 ⁽⁹⁾
	BW								162,0 ⁽⁸⁾		169,0 ⁽⁹⁾		167,0 ⁽⁶⁾		172,0 ⁽¹⁾
68	B								103,0 ⁽⁷⁾		115,0 ⁽¹⁰⁾		120,0 ⁽¹⁰⁾		123,0 ⁽¹⁰⁾
	BW								145,0 ⁽⁸⁾		153,0 ⁽⁹⁾		151,0 ⁽⁷⁾		154,0 ⁽¹⁾
72	B								90,2 ⁽⁷⁾		97,8 ⁽⁸⁾		107,0 ⁽¹⁰⁾		113,0 ⁽¹¹⁾
	BW								128,0 ⁽⁸⁾		136,0 ⁽⁸⁾		138,0 ⁽⁸⁾		138,0 ⁽⁶⁾
76	B										83,7 ⁽⁸⁾		93,8 ⁽⁹⁾		99,6 ⁽¹¹⁾
	BW										122,0 ⁽⁸⁾		126,0 ⁽⁸⁾		127,0 ⁽⁷⁾
80	B												80,6 ⁽⁹⁾		86,5 ⁽¹¹⁾
	BW												114,0 ⁽⁸⁾		118,0 ⁽⁹⁾
84	B												67,5 ⁽⁹⁾		73,3 ⁽⁹⁾
	BW												102,0 ⁽⁸⁾		107,0 ⁽⁹⁾
88	B												55,8 ⁽⁷⁾		64,2 ⁽⁹⁾
	BW												88,0 ⁽⁷⁾		94,4 ⁽⁹⁾
92	B												47,2 ⁽⁷⁾		
	BW												74,1 ⁽⁷⁾		

1) 12° 2) 17° 3) 22° 4) 27° 5) 32° 6) 37° 7) 42° 8) 47° 9) 52° 10) 57° 11) 62°

PDW3B/PDW3BW

P 60

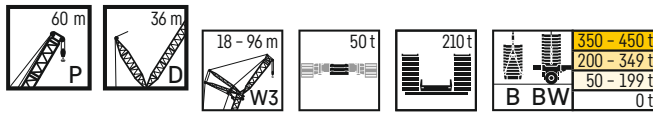

m		P 60 m													
		W3 60		W3 66		W3 72		W3 78		W3 84		W3 90		W3 96	
		87*/85	WVmax	87*/85	WVmax	87*/85	WVmax	87*/85	WVmax	87*/85	WVmax	87*/85	WVmax	87*/85	WVmax
24	B	304,0*	304,0*	277,0*	277,0*										
	BW	307,0*	307,0*	279,0*	279,0*										
26	B	299,0*	304,0 ⁽¹⁾	271,0*	273,0 ⁽¹⁾	246,0*	246,0*								
	BW	303,0*	309,0 ⁽¹⁾	275,0*	277,0 ⁽¹⁾	250,0*	250,0*								
28	B	303,0	303,0	266,0*	271,0 ⁽¹⁾	241,0*	244,0 ⁽¹⁾	220,0*	220,0*						
	BW	309,0	309,0	271,0*	276,0 ⁽¹⁾	245,0*	247,0 ⁽¹⁾	223,0*	223,0*						
30	B	297,0	297,0	269,0	269,0	243,0	243,0	216,0*	216,0*	195,0*	195,0*	179,0*	179,0*		
	BW	303,0	303,0	274,0	274,0	248,0	248,0	219,0*	219,0*	197,0*	197,0*	173,0*	173,0*		
32	B	290,0	290,0	264,0	264,0	240,0	240,0	212,0*	212,0*	192,0*	192,0*	176,0*	176,0*	152,0*	
	BW	297,0	297,0	270,0	270,0	244,0	244,0	215,0*	215,0*	194,0*	194,0*	178,0*	178,0*	153,0*	
34	B	282,0	282,0	260,0	260,0	236,0	236,0	215,0	215,0	189,0*	189,0*	173,0*	173,0*	156,0*	
	BW	292,0	292,0	265,0	265,0	241,0	241,0	219,0	219,0	191,0*	191,0*	176,0*	176,0*	158,0*	
36	B	272,0	272,0	256,0	256,0	232,0	232,0	212,0	212,0	190,0	190,0	170,0*	170,0*	153,0*	
	BW	283,0	287,0 ⁽²⁾	261,0	261,0	237,0	237,0	215,0	215,0	194,0	194,0	173,0*	173,0*	156,0*	
38	B	258,0	258,0	249,0	249,0	228,0	228,0	208,0	208,0	188,0	188,0	172,0	172,0	151,0*	
	BW	264,0	283,0 ⁽²⁾	254,0	257,0 ⁽²⁾	233,0	233,0	212,0	212,0	192,0	192,0	175,0	175,0	153,0*	
40	B	243,0	244,0 ⁽³⁾	238,0	239,0 ⁽³⁾	224,0	224,0	205,0	205,0	185,0	185,0	170,0	170,0	153,0	
	BW	246,0	278,0 ⁽²⁾	240,0	253,0 ⁽²⁾	228,0	230,0 ⁽²⁾	209,0	209,0	189,0	189,0	173,0	173,0	155,0	
44	B	212,0	219,0 ⁽¹⁾	210,0	216,0 ⁽¹⁾	206,0	207,0 ⁽¹⁾	197,0	197,0	180,0	180,0	165,0	165,0	149,0	
	BW	213,0	263,0 ⁽²⁾	210,0	246,0 ⁽²⁾	207,0	224,0 ⁽²⁾	200,0	205,0 ⁽²⁾	183,0	184,0 ⁽²⁾	168,0	168,0	151,0	
48	B	186,0	199,0 ⁽¹⁾	183,0	201,0 ⁽¹⁾	182,0	188,0 ⁽¹⁾	179,0	181,0 ⁽¹⁾	171,0	171,0	160,0	160,0	145,0	
	BW	186,0	237,0 ⁽²⁾	183,0	230,0 ⁽²⁾	182,0	217,0 ⁽²⁾	181,0	200,0 ⁽²⁾	173,0	180,0 ⁽²⁾	163,0	165,0 ⁽²⁾	147,0	
52	B	164,0	178,0 ⁽¹⁾	161,0	186,0 ⁽¹⁾	160,0	170,0 ⁽¹⁾	160,0	167,0 ⁽¹⁾	157,0	159,0 ⁽¹⁾	151,0	151,0	140,0	
	BW	164,0	222,0 ⁽²⁾	162,0	210,0 ⁽²⁾	161,0	202,0 ⁽²⁾	160,0	193,0 ⁽²⁾	157,0	177,0 ⁽²⁾	152,0	162,0 ⁽²⁾	142,0	
56	B	149,0	159,0 ⁽¹⁾	144,0	171,0 ⁽¹⁾	142,0	157,0 ⁽¹⁾	142,0	152,0 ⁽¹⁾	139,0	147,0 ⁽¹⁾	138,0	143,0 ⁽¹⁾	132,0	
	BW	149,0	208,0 ⁽¹⁾	144,0	192,0 ⁽¹⁾	142,0	187,0 ⁽¹⁾	142,0	181,0 ⁽¹⁾	139,0	169,0 ⁽¹⁾	138,0	158,0 ⁽¹⁾	132,0	
60	B	131,0	146,0 ⁽¹⁾	132,0	156,0 ⁽¹⁾	127,0	143,0 ⁽¹⁾	127,0	139,0 ⁽¹⁾	123,0	135,0 ⁽¹⁾	122,0	131,0 ⁽¹⁾	119,0	
	BW	131,0	194,0 ⁽¹⁾	132,0	176,0 ⁽¹⁾	128,0	173,0 ⁽¹⁾	127,0	168,0 ⁽¹⁾	124,0	158,0 ⁽¹⁾	123,0	149,0 ⁽¹⁾	119,0	
64	B	110,0	135,0 ⁽¹⁾	117,0	141,0 ⁽¹⁾	116,0	130,0 ⁽¹⁾	113,0	127,0 ⁽¹⁾	110,0	124,0 ⁽¹⁾	109,0	120,0 ⁽¹⁾	106,0	
	BW	110,0	179,0 ⁽¹⁾	117,0	161,0 ⁽¹⁾	117,0	159,0 ⁽¹⁾	113,0	156,0 ⁽¹⁾	110,0	147,0 ⁽¹⁾	109,0	140,0 ⁽¹⁾	106,0	
68	B	82,0	123,0 ⁽¹⁾	101,0	127,0 ⁽¹⁾	105,0	118,0 ⁽¹⁾	104,0	117,0 ⁽¹⁾	98,9	113,0 ⁽¹⁾	98,1	111,0 ⁽¹⁾	94,6	
	BW	82,4	165,0 ⁽¹⁾	101,0	148,0 ⁽¹⁾	105,0	146,0 ⁽¹⁾	104,0	144,0 ⁽¹⁾	99,0	137,0 ⁽¹⁾	98,1	130,0 ⁽¹⁾	95,0	
72	B		112,0 ⁽¹⁾	82,4	112,0 ⁽¹⁾	91,7	107,0 ⁽¹⁾	94,3	105,0 ⁽¹⁾	89,4	103,0 ⁽¹⁾	87,9	101,0 ⁽¹⁾	84,9	
	BW		151,0 ⁽¹⁾	82,5	135,0 ⁽¹⁾	91,7	132,0 ⁽¹⁾	94,4	132,0 ⁽¹⁾	89,5	127,0 ⁽¹⁾	88,3	122,0 ⁽¹⁾	85,1	
76	B		102,0 ⁽¹⁾		101,0 ⁽¹⁾	77,7	98,5 ⁽¹⁾	84,1	96,2 ⁽¹⁾	81,9	93,6 ⁽¹⁾	79,4	91,3 ⁽¹⁾	75,7	
	BW		137,0 ⁽¹⁾		122,0 ⁽¹⁾	77,9	121,0 ⁽¹⁾	84,0	120,0 ⁽¹⁾	82,0	117,0 ⁽¹⁾	79,7	113,0 ⁽¹⁾	76,7	
80	B		92,6 ⁽¹⁾		92,1 ⁽¹⁾	58,0	90,3 ⁽¹⁾	72,0	88,0 ⁽¹⁾	73,7	85,2 ⁽¹⁾	72,2	83,7 ⁽¹⁾	68,3	
	BW		122,0 ⁽¹⁾		112,0 ⁽¹⁾	58,1	110,0 ⁽¹⁾	72,1	109,0 ⁽¹⁾	74,1	107,0 ⁽¹⁾	73,2	104,0 ⁽¹⁾	68,8	
84	B		81,3 ⁽¹⁾		83,5 ⁽¹⁾		83,1 ⁽¹⁾	58,8	81,7 ⁽¹⁾	64,4	78,3 ⁽¹⁾	66,1	76,1 ⁽¹⁾	62,3	
	BW		108,0 ⁽¹⁾		104,0 ⁽¹⁾		102,0 ⁽¹⁾	58,8	100,0 ⁽¹⁾	64,6	97,0 ⁽¹⁾	66,7	95,7 ⁽¹⁾	62,1	
88	B		68,8 ⁽¹⁾		75,3 ⁽¹⁾		77,6 ⁽¹⁾		75,8 ⁽¹⁾	54,0	72,1 ⁽¹⁾	58,7	70,0 ⁽¹⁾	57,6	
	BW		100,0 ⁽¹⁾		97,2 ⁽¹⁾		94,4 ⁽¹⁾		92,8 ⁽¹⁾	54,2	89,5 ⁽¹⁾	58,7	87,3 ⁽¹⁾	57,3	
92	B		60,7 ⁽¹⁾		67,1 ⁽¹⁾		69,5 ⁽¹⁾		70,2 ⁽¹⁾	38,8	67,1 ⁽¹⁾	49,6	64,1 ⁽¹⁾	51,4	
	BW		89,3 ⁽¹⁾		91,6 ⁽¹⁾		88,2 ⁽¹⁾		86,0 ⁽¹⁾	38,9	82,5 ⁽¹⁾	50,1	80,8 ⁽¹⁾	51,4	
96	B		52,7 ⁽¹⁾		57,4 ⁽¹⁾		61,5 ⁽¹⁾		64,2 ⁽¹⁾		62,1 ⁽¹⁾	39,0	59,6 ⁽¹⁾	43,7	
	BW		78,8 ⁽¹⁾		83,8 ⁽¹⁾		82,8 ⁽¹⁾		80,4 ⁽¹⁾		76,8 ⁽¹⁾	39,2	74,3 ⁽¹⁾	43,8	
100	B		43,8 ⁽¹⁾		49,3 ⁽¹⁾		52,5 ⁽¹⁾		56,9 ⁽¹⁾		56,8 ⁽¹⁾		55,2 ⁽¹⁾	35,1	
	BW		67,7 ⁽¹⁾		74,6 ⁽¹⁾		77,6 ⁽¹⁾		75,4 ⁽¹⁾		72,0 ⁽¹⁾		69,4 ⁽¹⁾	35,1	
104	B		36,6 ⁽¹⁾		40,3 ⁽¹⁾		45,7 ⁽¹⁾		49,5 ⁽¹⁾		50,3 ⁽¹⁾		50,6 ⁽¹⁾	24,4	
	BW		58,9 ⁽¹⁾		64,2 ⁽¹⁾		69,9 ⁽¹⁾		71,1 ⁽¹⁾		66,1 ⁽¹⁾		64,0 ⁽¹⁾	24,5	
108	B				34,3 ⁽¹⁾		38,8 ⁽¹⁾		41,8 ⁽¹⁾		43,8 ⁽¹⁾		45,4 ⁽¹⁾	44,0 ⁽¹⁾	
	BW				56,4 ⁽¹⁾		62,2 ⁽¹⁾		64,3 ⁽¹⁾		60,7 ⁽¹⁾		59,0 ⁽¹⁾	56,0 ⁽¹⁾	
112	B						31,2 ⁽¹⁾		35,4 ⁽¹⁾		36,5 ⁽¹⁾		39,4 ⁽¹⁾	38,5 ⁽¹⁾	
	BW						52,6 ⁽¹⁾		57,7 ⁽¹⁾		56,8 ⁽¹⁾		53,9 ⁽¹⁾	51,2 ⁽¹⁾	
116	B						25,3 ⁽¹⁾		28,0 ⁽¹⁾		30,7 ⁽¹⁾		33,4 ⁽¹⁾	33,2 ⁽¹⁾	
	BW						44,9 ⁽¹⁾		49,6 ⁽¹⁾		51,2 ⁽¹⁾		50,1 ⁽¹⁾	46,2 ⁽¹⁾	
120	B								22,8 ⁽¹⁾		24,9 ⁽¹⁾		26,8 ⁽¹⁾	28,1 ⁽¹⁾	
	BW								42,9 ⁽¹⁾		45,6 ⁽¹⁾		45,8 ⁽¹⁾	41,6 ⁽¹⁾	
124	B										18,1 ⁽¹⁾		21,4 ⁽¹⁾	22,0 ⁽¹⁾	
	BW										38,7 ⁽¹⁾		40,8 ⁽¹⁾	38,1 ⁽¹⁾	
128	B										13,3 ⁽¹⁾		14,4 ⁽¹⁾	16,7 ⁽¹⁾	
	BW										33,2 ⁽¹⁾		34,4 ⁽¹⁾	34,2 ⁽¹⁾	
132	B												9,7 ⁽¹⁾	11,4 ⁽¹⁾	
	BW												29,2 ⁽¹⁾	30,3 ⁽¹⁾	
136	B													24,5 ⁽¹⁾	
	BW														
140	B														
	BW													19,7 ⁽¹⁾	

1) 12° 2) 17° 3) 22° 4) 27° 5) 32° 6) 37° 7) 42° 8) 47° 9) 52° 10) 57° 11) 62°

PDW3B/PDW3BW

P 66

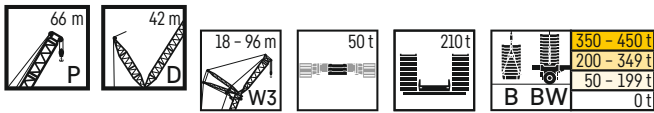

m	B BW	P 66 m													
		W3 18 m		W3 24 m		W3 30 m		W3 36 m		W3 42 m		W3 48 m		W3 54 m	
		87°/85	WVmax	87°/85	WVmax	87°/85	WVmax	87°/85	WVmax	87°/85	WVmax	87°/85	WVmax	87°/85	WVmax
14	B	594,0*	594,0*												
	BW	605,0*	605,0*												
16	B	594,0	594,0	528,0*	528,0*	504,0*	504,0*								
	BW	633,0	633,0	538,0*	538,0*	515,0*	515,0*								
18	B	557,0	558,0 ⁽²⁾	534,0	534,0	483,0*	500,0 ⁽¹⁾	449,0*	449,0*						
	BW	582,0	594,0 ⁽²⁾	565,0	565,0	494,0*	519,0 ⁽¹⁾	459,0*	459,0*						
20	B	502,0	523,0 ⁽²⁾	501,0	501,0	488,0	489,0 ⁽¹⁾	433,0*	454,0 ⁽¹⁾	404,0*	404,0*	368,0*	368,0*		
	BW	505,0	574,0 ⁽²⁾	526,0	531,0 ⁽²⁾	516,0	517,0 ⁽¹⁾	442,0*	468,0 ⁽¹⁾	412,0*	412,0*	373,0*	373,0*		
22	B	424,0	488,0 ⁽³⁾	465,0	472,0 ⁽²⁾	461,0	461,0	443,0	443,0	390,0*	409,0 ⁽¹⁾	361,0*	366,0 ⁽¹⁾	329,0*	329,0*
	BW	423,0	554,0 ⁽²⁾	468,0	515,0 ⁽²⁾	494,0	502,0 ⁽¹⁾	463,0	465,0 ⁽¹⁾	399,0*	419,0 ⁽¹⁾	366,0*	372,0 ⁽¹⁾	333,0*	333,0*
24	B	362,0	453,0 ⁽³⁾	402,0	442,0 ⁽²⁾	437,0	437,0	421,0	421,0	398,0	398,0	369,0	369,0	323,0*	323,0*
	BW	362,0	534,0 ⁽²⁾	401,0	499,0 ⁽²⁾	469,0	488,0 ⁽¹⁾	448,0	455,0 ⁽¹⁾	415,0	415,0	376,0	376,0	328,0*	328,0*
26	B	282,0	420,0 ⁽²⁾	350,0	413,0 ⁽³⁾	414,0	414,0	400,0	400,0	378,0	379,0 ⁽¹⁾	361,0	361,0	316,0*	316,0*
	BW	282,0	509,0 ⁽²⁾	348,0	483,0 ⁽²⁾	441,0	473,0 ⁽¹⁾	429,0	445,0 ⁽¹⁾	406,0	406,0	370,0	370,0	322,0*	322,0*
28	B		389,0 ⁽³⁾	313,0	385,0 ⁽³⁾	390,0	390,0	380,0	380,0	362,0	362,0	348,0	348,0	322,0	322,0
	BW		484,0 ⁽²⁾	312,0	465,0 ⁽²⁾	413,0	457,0 ⁽¹⁾	406,0	434,0 ⁽¹⁾	389,0	396,0 ⁽²⁾	363,0	363,0	331,0	331,0
30	B		363,0 ⁽⁶⁾	276,0	359,0 ⁽³⁾	364,0	365,0 ⁽⁵⁾	358,0	358,0	345,0	345,0	333,0	337,0 ⁽¹⁾	315,0	315,0
	BW		459,0 ⁽²⁾	277,0	444,0 ⁽²⁾	378,0	438,0 ⁽²⁾	381,0	423,0 ⁽¹⁾	371,0	386,0 ⁽²⁾	352,0	356,0 ⁽²⁾	324,0	324,0
32	B		338,0 ⁽⁶⁾	225,0	336,0 ⁽⁴⁾	339,0	342,0 ⁽⁶⁾	337,0	337,0	329,0	329,0	319,0	327,0 ⁽¹⁾	306,0	306,0
	BW		434,0 ⁽²⁾	225,0	423,0 ⁽²⁾	341,0	420,0 ⁽³⁾	357,0	405,0 ⁽²⁾	350,0	376,0 ⁽²⁾	338,0	349,0 ⁽²⁾	316,0	319,0 ⁽²⁾
34	B		313,0 ⁽⁷⁾		315,0 ⁽⁵⁾	301,0	321,0 ⁽⁶⁾	317,0	317,0	313,0	313,0	306,0	316,0 ⁽¹⁾	295,0	295,0
	BW		411,0 ⁽²⁾		401,0 ⁽²⁾	301,0	402,0 ⁽⁴⁾	326,0	388,0 ⁽²⁾	326,0	367,0 ⁽²⁾	319,0	343,0 ⁽²⁾	307,0	315,0 ⁽²⁾
36	B		292,0 ⁽²⁾		294,0 ⁽⁵⁾	255,0	300,0 ⁽⁷⁾	299,0	299,0	295,0	295,0	290,0	305,0 ⁽¹⁾	283,0	283,0
	BW		389,0 ⁽²⁾		382,0 ⁽²⁾	255,0	382,0 ⁽⁴⁾	299,0	374,0 ⁽³⁾	298,0	355,0 ⁽²⁾	296,0	337,0 ⁽²⁾	292,0	311,0 ⁽²⁾
38	B		275,0 ⁽⁴⁾		274,0 ⁽⁶⁾	206,0	281,0 ⁽⁷⁾	279,0	283,0 ⁽⁷⁾	274,0	281,0 ⁽¹⁾	271,0	294,0 ⁽¹⁾	269,0	269,0
	BW		367,0 ⁽³⁾		362,0 ⁽²⁾	207,0	361,0 ⁽⁴⁾	280,0	355,0 ⁽⁴⁾	275,0	342,0 ⁽³⁾	273,0	331,0 ⁽²⁾	273,0	308,0 ⁽²⁾
40	B		259,0 ⁽⁸⁾		257,0 ⁽³⁾		263,0 ⁽⁸⁾	250,0	266,0 ⁽⁷⁾	254,0	267,0 ⁽¹⁾	251,0	283,0 ⁽¹⁾	252,0	255,0 ⁽³⁾
	BW		345,0 ⁽³⁾		343,0 ⁽²⁾		340,0 ⁽¹⁾	252,0	338,0 ⁽⁴⁾	254,0	328,0 ⁽³⁾	253,0	318,0 ⁽²⁾	253,0	304,0 ⁽²⁾
44	B		229,0 ⁽⁹⁾		231,0 ⁽¹⁰⁾		235,0 ⁽⁹⁾	177,0	236,0 ⁽⁸⁾	224,0	240,0 ⁽¹⁾	218,0	262,0 ⁽¹⁾	218,0	230,0 ⁽⁴⁾
	BW		304,0 ⁽⁴⁾		306,0 ⁽³⁾		306,0 ⁽³⁾	177,0	304,0 ⁽⁴⁾	224,0	303,0 ⁽¹⁾	219,0	292,0 ⁽²⁾	218,0	285,0 ⁽²⁾
48	B		199,0 ⁽⁹⁾		207,0 ⁽¹⁰⁾		207,0 ⁽¹⁰⁾		212,0 ⁽⁹⁾	184,0	212,0 ⁽¹⁾	195,0	240,0 ⁽¹⁾	191,0	208,0 ⁽¹⁾
	BW		267,0 ⁽⁹⁾		271,0 ⁽³⁾		278,0 ⁽⁷⁾		275,0 ⁽⁴⁾	184,0	281,0 ⁽¹⁾	195,0	267,0 ⁽²⁾	191,0	264,0 ⁽²⁾
52	B				183,0 ⁽¹⁰⁾		186,0 ⁽¹⁰⁾		189,0 ⁽¹⁰⁾		192,0 ⁽⁹⁾	166,0	218,0 ⁽¹⁾	170,0	189,0 ⁽¹⁾
	BW				242,0 ⁽⁶⁾		252,0 ⁽⁷⁾		251,0 ⁽⁶⁾		259,0 ⁽¹⁾	166,0	245,0 ⁽²⁾	170,0	243,0 ⁽²⁾
56	B						166,0 ⁽¹⁰⁾		169,0 ⁽¹⁰⁾		175,0 ⁽¹⁰⁾	129,0	197,0 ⁽¹⁾	151,0	171,0 ⁽⁶⁾
	BW						227,0 ⁽⁷⁾		229,0 ⁽⁷⁾		237,0 ⁽¹⁾	129,0	225,0 ⁽³⁾	151,0	223,0 ⁽²⁾
60	B						146,0 ⁽¹⁰⁾		152,0 ⁽¹⁰⁾		156,0 ⁽¹¹⁾		175,0 ⁽¹⁾	126,0	157,0 ⁽⁷⁾
	BW						202,0 ⁽¹⁰⁾		208,0 ⁽⁸⁾		215,0 ⁽¹⁾		205,0 ⁽³⁾	126,0	204,0 ⁽²⁾
64	B								135,0 ⁽¹⁰⁾		140,0 ⁽¹⁰⁾		154,0 ⁽¹⁾		144,0 ⁽⁹⁾
	BW								188,0 ⁽⁸⁾		193,0 ⁽¹⁾		187,0 ⁽⁴⁾		186,0 ⁽³⁾
68	B								117,0 ⁽⁸⁾		126,0 ⁽¹⁰⁾		132,0 ⁽¹⁾		131,0 ⁽⁹⁾
	BW								170,0 ⁽⁸⁾		171,0 ⁽⁷⁾		169,0 ⁽⁵⁾		169,0 ⁽³⁾
72	B								103,0 ⁽⁸⁾		111,0 ⁽¹⁰⁾		115,0 ⁽¹⁰⁾		119,0 ⁽¹⁰⁾
	BW								155,0 ⁽⁸⁾		158,0 ⁽⁸⁾		156,0 ⁽⁴⁾		155,0 ⁽⁴⁾
76	B								89,0 ⁽⁸⁾		97,4 ⁽⁸⁾		103,0 ⁽¹⁰⁾		109,0 ⁽¹¹⁾
	BW								140,0 ⁽⁸⁾		145,0 ⁽⁸⁾		145,0 ⁽⁷⁾		144,0 ⁽⁵⁾
80	B										85,8 ⁽⁸⁾		89,3 ⁽⁸⁾		97,5 ⁽¹¹⁾
	BW										132,0 ⁽⁸⁾		134,0 ⁽⁸⁾		134,0 ⁽⁶⁾
84	B										73,3 ⁽⁶⁾		79,5 ⁽⁸⁾		86,1 ⁽¹¹⁾
	BW										118,0 ⁽⁶⁾		123,0 ⁽⁸⁾		126,0 ⁽⁹⁾
88	B										64,7 ⁽⁶⁾		69,7 ⁽⁸⁾		75,5 ⁽⁹⁾
	BW										107,0 ⁽⁶⁾		111,0 ⁽⁸⁾		116,0 ⁽⁹⁾
92	B												60,4 ⁽⁶⁾		66,8 ⁽⁹⁾
	BW												97,2 ⁽⁶⁾		106,0 ⁽⁹⁾
96	B												53,2 ⁽⁶⁾		57,4 ⁽⁷⁾
	BW												85,5 ⁽⁶⁾		94,0 ⁽⁷⁾
100	B														50,0 ⁽⁷⁾
	BW														83,7 ⁽⁷⁾

1) 12° 2) 17° 3) 22° 4) 27° 5) 32° 6) 37° 7) 42° 8) 47° 9) 52° 10) 57° 11) 62°

PDW3B/PDW3BW

P 66

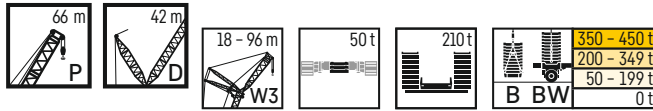

m		P 66 m													
		W3 60		W3 66		W3 72		W3 78		W3 84		W3 90		W3 96	
		87°/85	WVmax	87°/85	WVmax	87°/85	WVmax	87°/85	WVmax	87°/85	WVmax	87°/85	WVmax	87°/85	WVmax
24	B	293,0*	293,0*												
	BW	298,0*	298,0*												
26	B	287,0*	287,0*	263,0*	263,0*										
	BW	293,0*	293,0*	267,0*	267,0*										
28	B	281,0*	281,0*	257,0*	257,0*	233,0*	233,0*								
	BW	288,0*	288,0*	262,0*	262,0*	237,0*	237,0*								
30	B	286,0	286,0	252,0*	252,0*	228,0*	228,0*	208,0*	208,0*						
	BW	294,0	294,0	257,0*	257,0*	233,0*	233,0*	212,0*	212,0*						
32	B	281,0	281,0	257,0	257,0	232,0	232,0	204,0*	204,0*	185,0*	185,0*	170,0*	170,0*		
	BW	289,0	289,0	263,0	263,0	237,0	237,0	209,0*	209,0*	188,0*	188,0*	173,0*	173,0*		
34	B	274,0	274,0	252,0	252,0	228,0	228,0	207,0	207,0	182,0*	182,0*	167,0*	167,0*	151,0*	151,0*
	BW	284,0	285,0 ⁽²⁾	258,0	258,0	234,0	234,0	212,0	212,0	185,0*	185,0*	170,0*	170,0*	153,0*	153,0*
36	B	267,0	267,0	247,0	247,0	224,0	224,0	205,0	205,0	184,0	184,0	164,0*	164,0*	148,0*	148,0*
	BW	277,0	282,0 ⁽²⁾	254,0	255,0 ⁽²⁾	230,0	230,0	209,0	209,0	188,0	188,0	168,0*	168,0*	151,0*	151,0*
38	B	258,0	258,0	242,0	242,0	220,0	220,0	201,0	201,0	182,0	182,0	167,0	167,0	146,0*	146,0*
	BW	265,0	280,0 ⁽²⁾	249,0	252,0 ⁽²⁾	226,0	227,0 ⁽²⁾	206,0	206,0	186,0	186,0	170,0	170,0	149,0*	149,0*
40	B	246,0	246,0	235,0	235,0	216,0	216,0	198,0	198,0	179,0	179,0	165,0	165,0	148,0	148,0
	BW	250,0	277,0 ⁽²⁾	241,0	250,0 ⁽²⁾	223,0	225,0 ⁽²⁾	203,0	203,0	183,0	183,0	168,0	168,0	151,0	151,0
44	B	216,0	223,0 ⁽³⁾	214,0	217,0 ⁽³⁾	205,0	205,0	191,0	191,0	174,0	174,0	160,0	160,0	144,0	144,0
	BW	217,0	270,0 ⁽²⁾	216,0	246,0 ⁽²⁾	208,0	221,0 ⁽²⁾	196,0	200,0 ⁽²⁾	178,0	179,0 ⁽²⁾	164,0	164,0	147,0	147,0
48	B	189,0	202,0 ⁽⁴⁾	188,0	199,0 ⁽³⁾	185,0	193,0 ⁽²⁾	179,0	183,0 ⁽²⁾	166,0	168,0 ⁽²⁾	155,0	156,0 ⁽²⁾	140,0	141,0 ⁽²⁾
	BW	190,0	253,0 ⁽²⁾	189,0	237,0 ⁽²⁾	186,0	217,0 ⁽²⁾	182,0	196,0 ⁽²⁾	171,0	176,0 ⁽²⁾	159,0	160,0 ⁽²⁾	144,0	144,0
52	B	167,0	184,0 ⁽⁴⁾	165,0	181,0 ⁽³⁾	164,0	176,0 ⁽³⁾	162,0	174,0 ⁽²⁾	155,0	163,0 ⁽²⁾	148,0	152,0 ⁽²⁾	135,0	138,0 ⁽²⁾
	BW	167,0	235,0 ⁽²⁾	166,0	223,0 ⁽²⁾	164,0	206,0 ⁽²⁾	163,0	192,0 ⁽²⁾	159,0	173,0 ⁽²⁾	152,0	158,0 ⁽²⁾	139,0	142,0 ⁽²⁾
56	B	151,0	168,0 ⁽³⁾	148,0	166,0 ⁽⁴⁾	144,0	162,0 ⁽³⁾	144,0	159,0 ⁽³⁾	141,0	154,0 ⁽²⁾	137,0	148,0 ⁽²⁾	128,0	135,0 ⁽²⁾
	BW	152,0	218,0 ⁽²⁾	148,0	209,0 ⁽²⁾	145,0	194,0 ⁽²⁾	144,0	182,0 ⁽²⁾	141,0	168,0 ⁽²⁾	141,0	156,0 ⁽²⁾	132,0	139,0 ⁽²⁾
60	B	134,0	155,0 ⁽⁴⁾	135,0	153,0 ⁽³⁾	129,0	149,0 ⁽⁴⁾	128,0	146,0 ⁽³⁾	126,0	142,0 ⁽³⁾	125,0	137,0 ⁽²⁾	119,0	132,0 ⁽²⁾
	BW	134,0	201,0 ⁽²⁾	135,0	195,0 ⁽²⁾	130,0	182,0 ⁽²⁾	129,0	172,0 ⁽²⁾	126,0	159,0 ⁽²⁾	125,0	149,0 ⁽²⁾	122,0	137,0 ⁽²⁾
64	B	113,0	143,0 ⁽⁷⁾	121,0	139,0 ⁽⁴⁾	118,0	135,0 ⁽⁴⁾	115,0	135,0 ⁽⁴⁾	112,0	129,0 ⁽³⁾	111,0	128,0 ⁽³⁾	108,0	120,0 ⁽²⁾
	BW	113,0	184,0 ⁽²⁾	121,0	181,0 ⁽²⁾	118,0	170,0 ⁽²⁾	115,0	162,0 ⁽²⁾	112,0	150,0 ⁽²⁾	111,0	142,0 ⁽²⁾	108,0	130,0 ⁽²⁾
68	B	87,2	129,0 ⁽⁷⁾	105,0	127,0 ⁽⁴⁾	107,0	123,0 ⁽⁵⁾	105,0	122,0 ⁽⁴⁾	101,0	119,0 ⁽⁴⁾	99,3	116,0 ⁽³⁾	96,6	112,0 ⁽³⁾
	BW	87,7	167,0 ⁽²⁾	105,0	166,0 ⁽²⁾	107,0	159,0 ⁽²⁾	105,0	153,0 ⁽²⁾	101,0	142,0 ⁽²⁾	99,6	134,0 ⁽²⁾	96,4	124,0 ⁽²⁾
72	B		117,0 ⁽⁸⁾	86,5	116,0 ⁽⁸⁾	94,0	112,0 ⁽⁶⁾	96,4	111,0 ⁽⁵⁾	91,7	108,0 ⁽⁴⁾	89,4	106,0 ⁽⁴⁾	86,4	102,0 ⁽³⁾
	BW		153,0 ⁽³⁾	86,4	152,0 ⁽²⁾	93,7	148,0 ⁽²⁾	95,8	143,0 ⁽²⁾	91,7	134,0 ⁽²⁾	89,5	127,0 ⁽²⁾	86,3	118,0 ⁽²⁾
76	B		108,0 ⁽⁹⁾		107,0 ⁽⁸⁾	80,1	103,0 ⁽⁶⁾	86,0	102,0 ⁽⁵⁾	83,9	97,6 ⁽³⁾	80,9	96,5 ⁽⁴⁾	77,8	91,7 ⁽⁴⁾
	BW		140,0 ⁽⁴⁾		139,0 ⁽³⁾	80,0	136,0 ⁽²⁾	85,5	134,0 ⁽²⁾	84,1	127,0 ⁽²⁾	80,8	120,0 ⁽²⁾	77,9	111,0 ⁽²⁾
80	B		99,2 ⁽¹⁰⁾		98,6 ⁽⁹⁾	61,5	95,1 ⁽⁷⁾	74,1	93,3 ⁽⁶⁾	75,2	90,0 ⁽⁵⁾	73,6	87,3 ⁽⁵⁾	70,4	83,8 ⁽⁴⁾
	BW		131,0 ⁽⁵⁾		129,0 ⁽³⁾	61,5	125,0 ⁽²⁾	74,1	124,0 ⁽²⁾	75,3	119,0 ⁽²⁾	73,5	113,0 ⁽²⁾	70,3	105,0 ⁽²⁾
84	B		89,2 ⁽¹⁰⁾		92,1 ⁽¹⁰⁾		88,6 ⁽⁸⁾	60,7	86,1 ⁽⁷⁾	66,0	82,5 ⁽⁴⁾	68,0	80,7 ⁽⁵⁾	62,9	75,8 ⁽⁵⁾
	BW		122,0 ⁽⁴⁾		120,0 ⁽⁴⁾		117,0 ⁽³⁾	60,8	115,0 ⁽²⁾	66,1	111,0 ⁽²⁾	68,0	107,0 ⁽²⁾	62,9	99,4 ⁽²⁾
88	B		79,3 ⁽¹¹⁾		83,1 ⁽¹⁰⁾		82,3 ⁽⁹⁾		80,4 ⁽⁸⁾	55,8	76,9 ⁽⁴⁾	59,9	74,0 ⁽³⁾	58,3	70,1 ⁽³⁾
	BW		115,0 ⁽⁷⁾		113,0 ⁽⁵⁾		109,0 ⁽⁴⁾		107,0 ⁽³⁾	55,9	103,0 ⁽²⁾	60,0	100,0 ⁽²⁾	58,4	93,4 ⁽²⁾
92	B		69,0 ⁽⁹⁾		74,0 ⁽¹⁰⁾		75,6 ⁽¹⁰⁾		74,7 ⁽⁹⁾	41,4	71,7 ⁽⁷⁾	51,4	69,3 ⁽⁴⁾	51,9	64,3 ⁽⁵⁾
	BW		107,0 ⁽⁸⁾		105,0 ⁽⁵⁾		102,0 ⁽⁴⁾		99,7 ⁽³⁾	42,0	95,7 ⁽²⁾	51,4	93,2 ⁽²⁾	52,4	87,4 ⁽²⁾
96	B		61,0 ⁽⁸⁾		65,4 ⁽¹¹⁾		67,4 ⁽¹⁰⁾		68,2 ⁽⁹⁾		66,6 ⁽⁸⁾	40,8	63,9 ⁽⁷⁾	44,9	59,8 ⁽⁴⁾
	BW		97,4 ⁽⁸⁾		96,9 ⁽⁸⁾		93,6 ⁽⁴⁾		92,0 ⁽³⁾		88,2 ⁽²⁾	40,9	86,4 ⁽²⁾	45,2	81,4 ⁽²⁾
100	B		53,1 ⁽⁹⁾		56,5 ⁽⁹⁾		59,3 ⁽¹⁰⁾		61,2 ⁽¹⁰⁾		61,0 ⁽⁹⁾		59,0 ⁽⁸⁾	36,5	54,6 ⁽⁷⁾
	BW		87,9 ⁽⁶⁾		89,6 ⁽⁶⁾		86,2 ⁽⁵⁾		84,4 ⁽⁴⁾		81,2 ⁽³⁾		79,7 ⁽²⁾	36,4	75,5 ⁽²⁾
104	B		45,1 ⁽⁷⁾		49,2 ⁽⁹⁾		50,7 ⁽⁹⁾		54,3 ⁽¹⁰⁾		54,4 ⁽⁹⁾		54,5 ⁽⁹⁾	26,6	50,2 ⁽⁷⁾
	BW		78,0 ⁽⁷⁾		82,3 ⁽⁸⁾		79,0 ⁽⁵⁾		77,6 ⁽⁴⁾		74,7 ⁽³⁾		72,9 ⁽²⁾	26,6	69,6 ⁽²⁾
108	B		38,5 ⁽⁷⁾		41,1 ⁽⁷⁾		43,9 ⁽⁹⁾		47,7 ⁽¹¹⁾		47,9 ⁽¹⁰⁾		48,6 ⁽⁹⁾		45,5 ⁽⁸⁾
	BW		69,0 ⁽⁷⁾		74,1 ⁽⁷⁾		73,3 ⁽⁸⁾		71,6 ⁽⁵⁾		68,8 ⁽⁴⁾		66,9 ⁽³⁾		63,7 ⁽²⁾
112	B				35,0 ⁽⁷⁾		37,1 ⁽⁹⁾		40,2 ⁽⁹⁾		42,0 ⁽¹⁰⁾		42,7 ⁽¹⁰⁾		40,8 ⁽⁹⁾
	BW				66,2 ⁽⁷⁾		67,9 ⁽⁹⁾		66,7 ⁽⁷⁾		63,2 ⁽⁴⁾		61,2 ⁽³⁾		58,1 ⁽³⁾
116	B						30,0 ⁽⁷⁾		33,9 ⁽⁹⁾		35,1 ⁽⁹⁾		37,3 ⁽¹⁰⁾		35,7 ⁽⁹⁾
	BW						60,8 ⁽⁷⁾		62,3 ⁽⁸⁾		58,5 ⁽⁵⁾		56,0 ⁽⁴⁾		53,2 ⁽³⁾
120	B						24,5 ⁽⁷⁾		26,6 ⁽⁷⁾		29,3 ⁽⁹⁾		32,1 ⁽¹¹⁾		31,0 ⁽¹⁰⁾
	BW						54,4 ⁽⁷⁾		56,6 ⁽⁷⁾		54,4 ⁽⁶⁾		52,0 ⁽⁵⁾		48,7 ⁽⁴⁾
124	B								21,4 ⁽⁷⁾		23,5 ⁽⁹⁾		25,4 ⁽⁹⁾		26,5 ⁽¹⁰⁾
	BW								50,4 ⁽⁷⁾		51,2 ⁽⁹⁾		48,3 ⁽⁴⁾		44,8 ⁽⁴⁾
128	B										16,8 ⁽⁷⁾		19,9 ⁽⁹⁾		20,3 ⁽⁹⁾
	BW										45,1 ⁽⁷⁾		45,1 ⁽⁷⁾		41,4 ⁽⁵⁾
132	B										11,9 ⁽⁷⁾				15,0 ⁽⁹⁾
	BW										39,5 ⁽⁷⁾		40,7 ⁽⁷⁾		38,5 ⁽⁶⁾
136	B												35,4 ⁽⁷⁾		9,7 ⁽⁹⁾
	BW														35,8 ⁽⁹⁾
140	B														
	BW														30,5 ⁽⁷⁾
144	B														
	BW														25,5 ⁽⁷⁾

1) 12° 2) 17° 3) 22° 4) 27° 5) 32° 6) 37° 7) 42° 8) 47° 9) 52° 10) 57° 11) 62°

PDW3B/PDW3BW

P 72

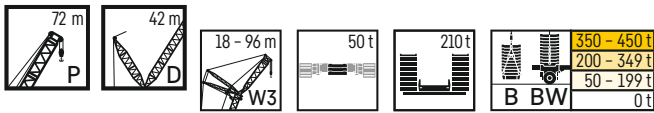

m		P 72 m													
		W3 18 m		W3 24 m		W3 30 m		W3 36 m		W3 42 m		W3 48 m		W3 54 m	
		87°/85	WVmax	87°/85	WVmax	87°/85	WVmax	87°/85	WVmax	87°/85	WVmax	87°/85	WVmax	87°/85	WVmax
14	B	564,0*	564,0*												
	BW	574,0*	574,0*												
16	B	520,0*	546,0 ⁽²⁾	500,0*	500,0*	472,0*	472,0*								
	BW	530,0*	563,0 ⁽²⁾	511,0*	511,0*	482,0*	482,0*								
18	B	539,0	539,0	466,0*	486,0 ⁽²⁾	452,0*	471,0 ⁽¹⁾	423,0*	423,0*						
	BW	562,0	565,0 ⁽²⁾	475,0*	501,0 ⁽²⁾	463,0*	481,0 ⁽¹⁾	432,0*	432,0*						
20	B	507,0	508,0 ⁽²⁾	485,0	485,0	470,0	470,0	406,0*	424,0 ⁽¹⁾	381,0*	381,0*				
	BW	517,0	548,0 ⁽²⁾	506,0	506,0	483,0	483,0	416,0*	437,0 ⁽¹⁾	389,0*	389,0*				
22	B	443,0	476,0 ⁽⁴⁾	458,0	458,0	446,0	446,0	420,0	421,0 ⁽¹⁾	368,0*	388,0 ⁽¹⁾	344,0*	350,0 ⁽¹⁾		
	BW	444,0	531,0 ⁽²⁾	474,0	492,0 ⁽²⁾	467,0	472,0 ⁽¹⁾	438,0	438,0	376,0*	397,0 ⁽¹⁾	351,0*	351,0*		
24	B	378,0	445,0 ⁽⁴⁾	417,0	432,0 ⁽³⁾	424,0	424,0	400,0	401,0 ⁽¹⁾	384,0	384,0	332,0*	352,0 ⁽¹⁾	310,0*	310,0*
	BW	378,0	514,0 ⁽²⁾	417,0	480,0 ⁽²⁾	447,0	462,0 ⁽¹⁾	423,0	428,0 ⁽¹⁾	397,0	397,0	340,0*	341,0 ⁽¹⁾	317,0*	317,0*
26	B	306,0	414,0 ⁽⁴⁾	365,0	406,0 ⁽³⁾	402,0	402,0	380,0	382,0 ⁽¹⁾	367,0	367,0	347,0	348,0 ⁽¹⁾	299,0*	299,0*
	BW	306,0	496,0 ⁽²⁾	363,0	467,0 ⁽²⁾	424,0	451,0 ⁽¹⁾	407,0	418,0 ⁽¹⁾	384,0	385,0 ⁽¹⁾	357,0	357,0	308,0*	308,0*
28	B		384,0 ⁽³⁾	322,0	379,0 ⁽³⁾	382,0	382,0	363,0	363,0	351,0	351,0	333,0	338,0 ⁽¹⁾	311,0	311,0
	BW		472,0 ⁽²⁾	320,0	455,0 ⁽²⁾	400,0	441,0 ⁽¹⁾	387,0	408,0 ⁽¹⁾	369,0	375,0 ⁽¹⁾	347,0	347,0	321,0	321,0
30	B		358,0 ⁽⁵⁾	287,0	354,0 ⁽²⁾	359,0	359,0	346,0	346,0	335,0	335,0	319,0	328,0 ⁽¹⁾	301,0	301,0
	BW		449,0 ⁽²⁾	288,0	435,0 ⁽²⁾	376,0	425,0 ⁽¹⁾	365,0	398,0 ⁽¹⁾	353,0	367,0 ⁽²⁾	334,0	336,0 ⁽²⁾	312,0	312,0
32	B		336,0 ⁽⁷⁾	243,0	331,0 ⁽⁴⁾	337,0	337,0	329,0	329,0	320,0	320,0	306,0	318,0 ⁽¹⁾	290,0	290,0
	BW		425,0 ⁽³⁾	243,0	415,0 ⁽²⁾	350,0	407,0 ⁽²⁾	345,0	386,0 ⁽¹⁾	336,0	360,0 ⁽²⁾	320,0	332,0 ⁽²⁾	302,0	304,0 ⁽²⁾
34	B		313,0 ⁽⁷⁾		311,0 ⁽⁵⁾	311,0	318,0 ⁽⁷⁾	312,0	312,0	305,0	305,0	293,0	308,0 ⁽¹⁾	279,0	279,0
	BW		399,0 ⁽⁴⁾		394,0 ⁽²⁾	313,0	391,0 ⁽³⁾	326,0	371,0 ⁽¹⁾	318,0	353,0 ⁽²⁾	305,0	327,0 ⁽²⁾	290,0	302,0 ⁽²⁾
36	B		292,0 ⁽⁸⁾		293,0 ⁽⁶⁾	269,0	299,0 ⁽⁷⁾	295,0	295,0	289,0	289,0	279,0	298,0 ⁽¹⁾	268,0	268,0
	BW		364,0 ⁽⁶⁾		374,0 ⁽²⁾	269,0	375,0 ⁽⁴⁾	307,0	357,0 ⁽¹⁾	301,0	345,0 ⁽²⁾	291,0	323,0 ⁽²⁾	278,0	300,0 ⁽²⁾
38	B		270,0 ⁽⁹⁾		275,0 ⁽⁶⁾	222,0	279,0 ⁽⁷⁾	275,0	278,0 ⁽⁶⁾	274,0	276,0 ⁽¹⁾	266,0	288,0 ⁽¹⁾	258,0	258,0
	BW		307,0 ⁽⁹⁾		356,0 ⁽²⁾	223,0	359,0 ⁽⁵⁾	286,0	342,0 ⁽¹⁾	282,0	333,0 ⁽²⁾	275,0	319,0 ⁽²⁾	266,0	297,0 ⁽²⁾
40	B				258,0 ⁽⁷⁾		262,0 ⁽⁸⁾	258,0	263,0 ⁽⁷⁾	258,0	263,0 ⁽¹⁾	253,0	278,0 ⁽¹⁾	247,0	247,0
	BW				338,0 ⁽²⁾		340,0 ⁽⁵⁾	261,0	330,0 ⁽⁴⁾	261,0	321,0 ⁽³⁾	259,0	311,0 ⁽²⁾	254,0	295,0 ⁽²⁾
44	B				227,0 ⁽⁹⁾		234,0 ⁽¹⁰⁾	190,0	235,0 ⁽⁸⁾	229,0	237,0 ⁽¹⁾	224,0	258,0 ⁽¹⁾	223,0	225,0 ⁽⁴⁾
	BW				305,0 ⁽³⁾		303,0 ⁽⁵⁾	190,0	301,0 ⁽⁶⁾	229,0	294,0 ⁽³⁾	224,0	287,0 ⁽³⁾	222,0	281,0 ⁽²⁾
48	B				205,0 ⁽¹⁰⁾		208,0 ⁽¹⁰⁾		210,0 ⁽⁹⁾	192,0	211,0 ⁽¹⁾	199,0	238,0 ⁽¹⁾	196,0	205,0 ⁽⁵⁾
	BW				273,0 ⁽⁴⁾		274,0 ⁽⁵⁾		271,0 ⁽⁵⁾	192,0	274,0 ⁽¹⁾	200,0	264,0 ⁽³⁾	194,0	259,0 ⁽²⁾
52	B				183,0 ⁽¹⁰⁾		184,0 ⁽¹⁰⁾		189,0 ⁽¹⁰⁾		190,0 ⁽⁹⁾	171,0	218,0 ⁽¹⁾	173,0	185,0 ⁽⁵⁾
	BW				242,0 ⁽⁴⁾		250,0 ⁽⁸⁾		247,0 ⁽⁶⁾		254,0 ⁽¹⁾	172,0	241,0 ⁽²⁾	172,0	238,0 ⁽²⁾
56	B				161,0 ⁽¹⁰⁾		165,0 ⁽¹⁰⁾		168,0 ⁽¹¹⁾		173,0 ⁽¹⁰⁾	136,0	198,0 ⁽¹⁾	155,0	170,0 ⁽⁶⁾
	BW				219,0 ⁽⁷⁾		227,0 ⁽⁸⁾		227,0 ⁽⁸⁾		234,0 ⁽¹⁾	136,0	222,0 ⁽³⁾	154,0	219,0 ⁽²⁾
60	B				142,0 ⁽⁸⁾		146,0 ⁽¹⁰⁾		150,0 ⁽¹⁰⁾		155,0 ⁽¹¹⁾		178,0 ⁽¹⁾	131,0	155,0 ⁽⁷⁾
	BW				201,0 ⁽⁸⁾		204,0 ⁽⁸⁾		208,0 ⁽⁸⁾		213,0 ⁽¹⁾		204,0 ⁽⁴⁾	130,0	202,0 ⁽³⁾
64	B				127,0 ⁽⁸⁾		127,0 ⁽⁸⁾		134,0 ⁽¹⁰⁾		139,0 ⁽¹⁰⁾		158,0 ⁽¹⁾		144,0 ⁽⁹⁾
	BW				183,0 ⁽⁸⁾		183,0 ⁽⁸⁾		188,0 ⁽⁸⁾		193,0 ⁽¹⁾		186,0 ⁽⁵⁾		185,0 ⁽³⁾
68	B						114,0 ⁽⁷⁾		118,0 ⁽¹⁰⁾		125,0 ⁽¹⁰⁾		138,0 ⁽¹⁾		131,0 ⁽⁹⁾
	BW						167,0 ⁽⁸⁾		169,0 ⁽⁹⁾		173,0 ⁽¹⁾		171,0 ⁽⁵⁾		170,0 ⁽⁴⁾
72	B						100,0 ⁽⁷⁾		104,0 ⁽⁸⁾		111,0 ⁽¹⁰⁾		118,0 ⁽¹⁾		118,0 ⁽¹⁰⁾
	BW						151,0 ⁽⁸⁾		154,0 ⁽⁸⁾		157,0 ⁽⁹⁾		156,0 ⁽⁴⁾		155,0 ⁽⁴⁾
76	B								92,7 ⁽⁸⁾		96,4 ⁽⁸⁾		102,0 ⁽¹⁰⁾		108,0 ⁽¹¹⁾
	BW								140,0 ⁽⁸⁾		143,0 ⁽⁸⁾		143,0 ⁽⁸⁾		142,0 ⁽⁵⁾
80	B										86,2 ⁽⁸⁾		90,0 ⁽¹⁰⁾		96,8 ⁽¹¹⁾
	BW										131,0 ⁽⁸⁾		132,0 ⁽⁸⁾		131,0 ⁽⁶⁾
84	B										76,0 ⁽⁸⁾		78,6 ⁽⁸⁾		85,9 ⁽¹¹⁾
	BW										119,0 ⁽⁸⁾		121,0 ⁽⁸⁾		122,0 ⁽⁷⁾
88	B										65,7 ⁽⁶⁾		69,6 ⁽⁸⁾		74,2 ⁽⁹⁾
	BW										105,0 ⁽⁶⁾		110,0 ⁽⁸⁾		114,0 ⁽⁹⁾
92	B										59,2 ⁽⁶⁾		59,2 ⁽⁶⁾		65,9 ⁽⁹⁾
	BW										94,1 ⁽⁶⁾		97,7 ⁽⁶⁾		104,0 ⁽⁹⁾
96	B												52,0 ⁽⁶⁾		57,6 ⁽⁹⁾
	BW												88,3 ⁽⁶⁾		94,5 ⁽⁹⁾
100	B												44,8 ⁽⁶⁾		49,0 ⁽⁷⁾
	BW												78,9 ⁽⁶⁾		83,9 ⁽⁷⁾
104	B														42,3 ⁽⁷⁾
	BW														75,5 ⁽⁷⁾

1) 12° 2) 17° 3) 22° 4) 27° 5) 32° 6) 37° 7) 42° 8) 47° 9) 52° 10) 57° 11) 62°

PDW3B/PDW3BW

P 72

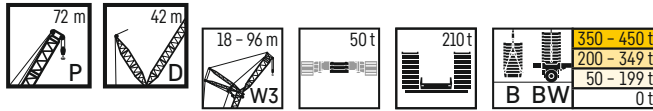

m		P 72 m													
		W3 60		W3 66		W3 72		W3 78		W3 84		W3 90		W3 96	
		87°/85	WVmax	87°/85	WVmax	87°/85	WVmax	87°/85	WVmax	87°/85	WVmax	87°/85	WVmax	87°/85	WVmax
26	B	278,0*	278,0*	254,0*	254,0*										
	BW	285,0*	285,0*	259,0*	259,0*										
28	B	268,0*	268,0*	248,0*	248,0*	225,0*	225,0*								
	BW	276,0*	276,0*	254,0*	254,0*	230,0*	230,0*								
30	B	278,0	278,0	241,0*	241,0*	222,0*	222,0*	202,0*	202,0*						
	BW	286,0	286,0	249,0*	249,0*	226,0*	226,0*	206,0*	206,0*						
32	B	271,0	271,0	249,0	249,0	216,0*	216,0*	198,0*	198,0*	180,0*	180,0*				
	BW	281,0	281,0	256,0	256,0	222,0*	222,0*	202,0*	202,0*	183,0*	183,0*				
34	B	262,0	262,0	244,0	244,0	223,0	223,0	194,0*	194,0*	177,0*	177,0*	162,0*	162,0*	146,0*	146,0*
	BW	273,0	274,0 ⁽²⁾	251,0	251,0	227,0	227,0	199,0*	199,0*	180,0*	180,0*	165,0*	165,0*	149,0*	149,0*
36	B	253,0	253,0	238,0	238,0	219,0	219,0	199,0	199,0	174,0*	174,0*	159,0*	159,0*	144,0*	144,0*
	BW	264,0	273,0 ⁽²⁾	246,0	247,0 ⁽²⁾	224,0	224,0	204,0	204,0	177,0*	177,0*	162,0*	162,0*	147,0*	147,0*
38	B	244,0	244,0	230,0	231,0 ⁽²⁾	215,0	215,0	196,0	196,0	178,0	178,0	162,0	162,0	141,0*	141,0*
	BW	254,0	271,0 ⁽²⁾	240,0	245,0 ⁽²⁾	220,0	220,0	201,0	201,0	181,0	181,0	166,0	166,0	144,0*	144,0*
40	B	235,0	235,0	222,0	224,0 ⁽²⁾	208,0	209,0 ⁽²⁾	192,0	192,0	175,0	175,0	160,0	160,0	144,0	144,0
	BW	244,0	270,0 ⁽²⁾	233,0	244,0 ⁽²⁾	216,0	219,0 ⁽²⁾	198,0	198,0	179,0	179,0	164,0	164,0	147,0	147,0
44	B	215,0	217,0 ⁽²⁾	206,0	210,0 ⁽²⁾	195,0	198,0 ⁽²⁾	181,0	184,0 ⁽²⁾	168,0	170,0 ⁽²⁾	155,0	155,0	140,0	140,0
	BW	220,0	267,0 ⁽²⁾	214,0	241,0 ⁽²⁾	204,0	216,0 ⁽²⁾	191,0	195,0 ⁽²⁾	174,0	175,0 ⁽²⁾	159,0	159,0	144,0	144,0
48	B	193,0	199,0 ⁽⁴⁾	190,0	195,0 ⁽²⁾	182,0	187,0 ⁽²⁾	170,0	176,0 ⁽²⁾	160,0	164,0 ⁽²⁾	148,0	150,0 ⁽²⁾	135,0	136,0 ⁽²⁾
	BW	193,0	251,0 ⁽²⁾	192,0	236,0 ⁽²⁾	187,0	213,0 ⁽²⁾	180,0	193,0 ⁽²⁾	168,0	172,0 ⁽²⁾	155,0	157,0 ⁽²⁾	140,0	140,0
52	B	170,0	181,0 ⁽⁴⁾	169,0	178,0 ⁽³⁾	167,0	173,0 ⁽²⁾	159,0	167,0 ⁽²⁾	149,0	158,0 ⁽²⁾	140,0	146,0 ⁽²⁾	129,0	133,0 ⁽²⁾
	BW	170,0	233,0 ⁽²⁾	169,0	223,0 ⁽²⁾	167,0	206,0 ⁽²⁾	164,0	190,0 ⁽²⁾	157,0	170,0 ⁽²⁾	149,0	155,0 ⁽²⁾	135,0	138,0 ⁽²⁾
56	B	154,0	166,0 ⁽³⁾	150,0	163,0 ⁽⁴⁾	149,0	159,0 ⁽³⁾	146,0	153,0 ⁽²⁾	140,0	150,0 ⁽²⁾	131,0	141,0 ⁽²⁾	122,0	129,0 ⁽²⁾
	BW	153,0	215,0 ⁽²⁾	150,0	209,0 ⁽²⁾	147,0	196,0 ⁽²⁾	147,0	183,0 ⁽²⁾	143,0	167,0 ⁽²⁾	140,0	153,0 ⁽²⁾	130,0	136,0 ⁽²⁾
60	B	137,0	152,0 ⁽⁴⁾	136,0	150,0 ⁽³⁾	133,0	147,0 ⁽⁴⁾	131,0	142,0 ⁽³⁾	128,0	137,0 ⁽³⁾	123,0	132,0 ⁽²⁾	114,0	126,0 ⁽²⁾
	BW	137,0	199,0 ⁽²⁾	136,0	196,0 ⁽²⁾	131,0	186,0 ⁽²⁾	131,0	174,0 ⁽²⁾	128,0	160,0 ⁽²⁾	127,0	149,0 ⁽²⁾	121,0	134,0 ⁽²⁾
64	B	116,0	141,0 ⁽⁷⁾	123,0	138,0 ⁽⁴⁾	121,0	135,0 ⁽³⁾	117,0	132,0 ⁽⁴⁾	116,0	127,0 ⁽³⁾	112,0	122,0 ⁽³⁾	106,0	116,0 ⁽²⁾
	BW	116,0	183,0 ⁽²⁾	123,0	181,0 ⁽²⁾	119,0	175,0 ⁽²⁾	117,0	166,0 ⁽²⁾	114,0	152,0 ⁽²⁾	113,0	142,0 ⁽²⁾	110,0	130,0 ⁽²⁾
68	B	92,7	129,0 ⁽⁸⁾	107,0	126,0 ⁽⁴⁾	110,0	124,0 ⁽³⁾	106,0	121,0 ⁽³⁾	104,0	119,0 ⁽⁴⁾	101,0	112,0 ⁽³⁾	96,9	108,0 ⁽³⁾
	BW	92,6	167,0 ⁽³⁾	107,0	167,0 ⁽²⁾	109,0	162,0 ⁽²⁾	106,0	156,0 ⁽²⁾	102,0	145,0 ⁽²⁾	101,0	136,0 ⁽²⁾	98,4	125,0 ⁽²⁾
72	B		118,0 ⁽⁹⁾	89,0	118,0 ⁽⁸⁾	96,7	114,0 ⁽⁴⁾	97,2	112,0 ⁽³⁾	94,4	108,0 ⁽³⁾	91,0	105,0 ⁽⁴⁾	87,7	98,4 ⁽⁴⁾
	BW		153,0 ⁽³⁾	89,2	152,0 ⁽²⁾	95,7	149,0 ⁽²⁾	97,4	145,0 ⁽²⁾	92,6	136,0 ⁽²⁾	90,8	130,0 ⁽²⁾	88,2	120,0 ⁽²⁾
76	B		107,0 ⁽⁹⁾		107,0 ⁽⁸⁾	83,0	104,0 ⁽⁸⁾	86,7	101,0 ⁽⁴⁾	86,7	99,5 ⁽³⁾	81,7	95,2 ⁽³⁾	79,0	92,4 ⁽⁴⁾
	BW		139,0 ⁽⁴⁾		139,0 ⁽³⁾	82,0	137,0 ⁽²⁾	87,2	134,0 ⁽²⁾	85,5	127,0 ⁽²⁾	81,9	122,0 ⁽²⁾	79,2	114,0 ⁽²⁾
80	B		97,5 ⁽¹⁰⁾		97,6 ⁽⁹⁾	65,9	96,4 ⁽⁸⁾	75,8	92,7 ⁽⁴⁾	78,0	90,2 ⁽⁴⁾	74,1	87,8 ⁽³⁾	71,5	83,0 ⁽⁴⁾
	BW		128,0 ⁽³⁾		127,0 ⁽³⁾	64,9	124,0 ⁽²⁾	75,8	124,0 ⁽²⁾	76,9	118,0 ⁽²⁾	74,4	114,0 ⁽²⁾	71,6	108,0 ⁽²⁾
84	B		88,6 ⁽¹¹⁾		89,4 ⁽¹⁰⁾		88,0 ⁽³⁾	62,5	85,3 ⁽⁷⁾	68,5	82,8 ⁽⁴⁾	68,0	79,3 ⁽³⁾	63,5	75,6 ⁽³⁾
	BW		119,0 ⁽³⁾		118,0 ⁽⁴⁾		114,0 ⁽³⁾	62,6	113,0 ⁽²⁾	67,3	110,0 ⁽²⁾	68,2	107,0 ⁽²⁾	63,5	101,0 ⁽²⁾
88	B		78,8 ⁽¹¹⁾		82,6 ⁽¹¹⁾		81,1 ⁽⁹⁾		78,7 ⁽⁸⁾	58,6	76,1 ⁽⁸⁾	60,6	72,6 ⁽⁴⁾	56,6	68,4 ⁽³⁾
	BW		111,0 ⁽⁷⁾		110,0 ⁽³⁾		106,0 ⁽⁴⁾		104,0 ⁽³⁾	57,4	101,0 ⁽²⁾	60,7	99,0 ⁽²⁾	59,2	94,4 ⁽²⁾
92	B		69,0 ⁽¹¹⁾		73,8 ⁽¹¹⁾		74,8 ⁽¹⁰⁾		72,9 ⁽⁹⁾	45,6	70,8 ⁽⁸⁾	52,7	66,2 ⁽⁴⁾	50,0	62,3 ⁽⁴⁾
	BW		105,0 ⁽⁹⁾		103,0 ⁽⁴⁾		98,7 ⁽⁴⁾		96,6 ⁽⁴⁾	45,0	93,1 ⁽³⁾	52,8	93,0 ⁽²⁾	53,2	87,7 ⁽²⁾
96	B		59,4 ⁽⁹⁾		65,0 ⁽¹¹⁾		67,1 ⁽¹¹⁾		67,8 ⁽¹⁰⁾		65,4 ⁽⁸⁾	42,6	61,3 ⁽⁷⁾	43,7	56,9 ⁽⁴⁾
	BW		96,8 ⁽⁹⁾		96,6 ⁽⁷⁾		92,5 ⁽³⁾		90,8 ⁽⁴⁾		86,7 ⁽³⁾	42,7	84,5 ⁽³⁾	46,5	81,1 ⁽²⁾
100	B		51,8 ⁽⁹⁾		55,1 ⁽⁹⁾		59,3 ⁽¹¹⁾		61,2 ⁽¹⁰⁾		60,8 ⁽⁹⁾		57,1 ⁽⁸⁾	37,4	52,4 ⁽⁷⁾
	BW		87,8 ⁽⁹⁾		90,1 ⁽⁹⁾		87,4 ⁽⁷⁾		85,4 ⁽³⁾		81,3 ⁽⁴⁾		79,0 ⁽³⁾	37,7	74,5 ⁽²⁾
104	B		43,0 ⁽⁷⁾		48,0 ⁽⁹⁾		51,5 ⁽¹¹⁾		53,9 ⁽¹⁰⁾		55,6 ⁽¹⁰⁾		53,3 ⁽⁹⁾	28,4	48,6 ⁽⁸⁾
	BW		77,5 ⁽⁷⁾		82,0 ⁽⁹⁾		81,5 ⁽⁹⁾		78,7 ⁽⁷⁾		75,5 ⁽³⁾		73,6 ⁽⁴⁾	28,5	69,7 ⁽³⁾
108	B		36,8 ⁽⁷⁾		40,9 ⁽⁹⁾		43,2 ⁽⁹⁾		46,6 ⁽¹¹⁾		48,9 ⁽¹⁰⁾		49,9 ⁽¹⁰⁾		45,0 ⁽⁹⁾
	BW		70,3 ⁽⁷⁾		73,9 ⁽⁹⁾		74,3 ⁽⁸⁾		73,5 ⁽³⁾		70,2 ⁽³⁾		68,5 ⁽⁴⁾		64,3 ⁽³⁾
112	B		30,7 ⁽⁷⁾		33,3 ⁽⁷⁾		36,7 ⁽⁹⁾		38,8 ⁽⁹⁾		42,1 ⁽¹⁰⁾		43,5 ⁽¹⁰⁾		41,2 ⁽⁹⁾
	BW		63,0 ⁽⁷⁾		65,2 ⁽⁷⁾		67,2 ⁽⁹⁾		68,0 ⁽⁸⁾		64,1 ⁽³⁾		62,5 ⁽⁴⁾		58,5 ⁽³⁾
116	B				27,7 ⁽⁷⁾		28,8 ⁽⁷⁾		32,8 ⁽⁹⁾		35,8 ⁽¹¹⁾		37,1 ⁽¹⁰⁾		36,9 ⁽¹⁰⁾
	BW				58,6 ⁽⁷⁾		59,1 ⁽⁷⁾		61,8 ⁽⁸⁾		58,4 ⁽⁹⁾		56,6 ⁽⁴⁾		53,0 ⁽⁴⁾
120	B						23,5 ⁽⁷⁾		26,7 ⁽⁹⁾		28,3 ⁽⁹⁾		30,7 ⁽¹¹⁾		31,1 ⁽¹⁰⁾
	BW						52,9 ⁽⁷⁾		55,7 ⁽⁸⁾		53,8 ⁽⁹⁾		51,5 ⁽⁸⁾		48,5 ⁽³⁾
124	B						18,2 ⁽⁷⁾		19,4 ⁽⁷⁾		22,5 ⁽⁹⁾		23,2 ⁽⁹⁾		25,3 ⁽¹¹⁾
	BW						46,7 ⁽⁷⁾		48,9 ⁽⁷⁾		49,2 ⁽⁹⁾		47,6 ⁽⁹⁾		44,0 ⁽³⁾
128	B								14,3 ⁽⁷⁾				17,7 ⁽⁹⁾		20,0 ⁽¹¹⁾
	BW								43,1 ⁽⁷⁾			43,3 ⁽⁷⁾			40,0 ⁽⁴⁾
132	B												12,3 ⁽⁹⁾		
	BW											37,9 ⁽⁷⁾			36,1 ⁽⁹⁾
136	B														
	BW											32,5 ⁽⁷⁾			33,0 ⁽⁹⁾
140	B														
	BW												28,6 ⁽⁷⁾		28,8 ⁽⁷⁾
144	B														
	BW														24,0 ⁽⁷⁾
148	B														
	BW														19,3 ⁽⁷⁾

1) 12° 2) 17° 3) 22° 4) 27° 5) 32° 6) 37° 7) 42° 8) 47° 9) 52° 10) 57° 11) 62°

PDW3B/PDW3BW

P 78

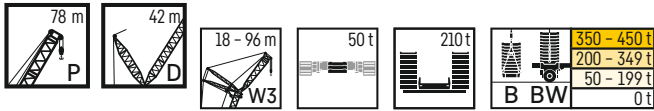

m		P 78 m													
		W3 18 m		W3 24 m		W3 30 m		W3 36 m		W3 42 m		W3 48 m		W3 54 m	
		87°/85	WVmax	87°/85	WVmax	87°/85	WVmax	87°/85	WVmax	87°/85	WVmax	87°/85	WVmax	87°/85	WVmax
14	B	524,0*	524,0*												
	BW	534,0*	534,0*												
16	B	498,0*	512,0 ⁽²⁾	466,0*	466,0*										
	BW	508,0*	525,0 ⁽²⁾	475,0*	475,0*										
18	B	517,0	517,0	442,0*	456,0 ⁽²⁾	418,0*	431,0 ⁽¹⁾	389,0*	389,0*						
	BW	533,0	533,0	448,0*	465,0 ⁽²⁾	427,0*	440,0 ⁽¹⁾	397,0*	397,0*						
20	B	486,0	489,0 ⁽²⁾	465,0	465,0	436,0	436,0	375,0*	390,0 ⁽¹⁾	351,0*	351,0*				
	BW	500,0	517,0 ⁽²⁾	475,0	475,0	443,0	443,0	383,0*	398,0 ⁽¹⁾	357,0*	357,0*				
22	B	457,0	461,0 ⁽²⁾	439,0	442,0 ⁽²⁾	419,0	419,0	393,0	393,0	339,0*	353,0 ⁽¹⁾	315,0*	315,0*		
	BW	461,0	504,0 ⁽²⁾	446,0	460,0 ⁽²⁾	433,0	435,0 ⁽¹⁾	400,0	400,0	345,0*	363,0 ⁽¹⁾	321,0*	321,0*		
24	B	394,0	433,0 ⁽⁴⁾	414,0	418,0 ⁽²⁾	400,0	400,0	379,0	379,0	354,0	354,0	304,0*	319,0 ⁽¹⁾	284,0*	
	BW	394,0	491,0 ⁽²⁾	419,0	451,0 ⁽²⁾	417,0	427,0 ⁽¹⁾	391,0	394,0 ⁽¹⁾	366,0	366,0	312,0*	314,0 ⁽¹⁾	292,0*	
26	B	329,0	406,0 ⁽⁴⁾	377,0	395,0 ⁽²⁾	380,0	381,0 ⁽¹⁾	362,0	363,0 ⁽¹⁾	341,0	342,0 ⁽¹⁾	317,0	317,0	274,0*	
	BW	329,0	478,0 ⁽²⁾	376,0	443,0 ⁽²⁾	400,0	419,0 ⁽¹⁾	377,0	389,0 ⁽¹⁾	355,0	356,0 ⁽¹⁾	330,0	330,0	282,0*	
28	B		379,0 ⁽²⁾	332,0	371,0 ⁽²⁾	363,0	363,0	346,0	347,0 ⁽¹⁾	328,0	330,0 ⁽¹⁾	306,0	306,0	287,0	
	BW		459,0 ⁽²⁾	330,0	435,0 ⁽²⁾	380,0	412,0 ⁽¹⁾	362,0	384,0 ⁽¹⁾	341,0	348,0 ⁽¹⁾	318,0	318,0	297,0	
30	B		353,0 ⁽⁴⁾	298,0	348,0 ⁽⁴⁾	346,0	346,0	330,0	332,0 ⁽¹⁾	314,0	318,0 ⁽¹⁾	294,0	295,0 ⁽²⁾	277,0	
	BW		437,0 ⁽²⁾	297,0	422,0 ⁽²⁾	359,0	402,0 ⁽¹⁾	345,0	378,0 ⁽¹⁾	326,0	339,0 ⁽²⁾	307,0	309,0 ⁽²⁾	289,0	
32	B		331,0 ⁽⁶⁾	259,0	327,0 ⁽⁴⁾	328,0	329,0 ⁽⁶⁾	315,0	317,0 ⁽¹⁾	300,0	306,0 ⁽¹⁾	283,0	284,0 ⁽²⁾	267,0	
	BW		416,0 ⁽³⁾	258,0	404,0 ⁽³⁾	339,0	387,0 ⁽¹⁾	326,0	372,0 ⁽¹⁾	312,0	336,0 ⁽²⁾	295,0	307,0 ⁽²⁾	279,0 ⁽²⁾	
34	B		310,0 ⁽⁸⁾		307,0 ⁽⁴⁾	313,0	313,0	299,0	300,0 ⁽⁵⁾	287,0	294,0 ⁽¹⁾	272,0	274,0 ⁽²⁾	257,0	
	BW		394,0 ⁽³⁾		385,0 ⁽³⁾	320,0	372,0 ⁽¹⁾	309,0	359,0 ⁽¹⁾	297,0	332,0 ⁽²⁾	282,0	305,0 ⁽²⁾	269,0	
36	B		290,0 ⁽⁸⁾		289,0 ⁽⁶⁾	282,0	295,0 ⁽⁸⁾	283,0	284,0 ⁽⁵⁾	274,0	282,0 ⁽¹⁾	261,0	264,0 ⁽²⁾	248,0	
	BW		369,0 ⁽⁵⁾		367,0 ⁽³⁾	283,0	357,0 ⁽¹⁾	294,0	346,0 ⁽¹⁾	282,0	328,0 ⁽²⁾	270,0	304,0 ⁽²⁾	258,0	
38	B		270,0 ⁽⁸⁾		273,0 ⁽⁸⁾	236,0	278,0 ⁽⁸⁾	270,0	270,0	261,0	270,0 ⁽¹⁾	250,0	253,0 ⁽²⁾	239,0	
	BW		344,0 ⁽⁷⁾		348,0 ⁽²⁾	237,0	344,0 ⁽⁵⁾	279,0	332,0 ⁽¹⁾	268,0	322,0 ⁽²⁾	257,0	302,0 ⁽²⁾	247,0	
40	B		250,0 ⁽¹⁰⁾		257,0 ⁽⁸⁾		261,0 ⁽⁸⁾	258,0	258,0	248,0	258,0 ⁽¹⁾	238,0	243,0 ⁽²⁾	230,0	
	BW		287,0 ⁽¹⁰⁾		332,0 ⁽²⁾		333,0 ⁽⁶⁾	266,0	322,0 ⁽⁴⁾	256,0	310,0 ⁽³⁾	245,0	301,0 ⁽²⁾	236,0	
44	B				227,0 ⁽⁹⁾		231,0 ⁽⁹⁾	202,0	232,0 ⁽⁸⁾	227,0	234,0 ⁽¹⁾	217,0	226,0 ⁽¹⁾	212,0	
	BW				300,0 ⁽⁴⁾		301,0 ⁽⁶⁾	203,0	297,0 ⁽⁵⁾	232,0	290,0 ⁽⁴⁾	224,0	282,0 ⁽³⁾	217,0	
48	B				202,0 ⁽¹⁰⁾		206,0 ⁽¹⁰⁾		208,0 ⁽⁹⁾	200,0	210,0 ⁽¹⁾	199,0	210,0 ⁽¹⁾	194,0	
	BW				272,0 ⁽⁵⁾		271,0 ⁽⁷⁾		271,0 ⁽⁶⁾	199,0	265,0 ⁽⁴⁾	203,0	259,0 ⁽³⁾	197,0	
52	B				181,0 ⁽¹⁰⁾		182,0 ⁽¹¹⁾		187,0 ⁽¹¹⁾		188,0 ⁽⁹⁾	175,0	194,0 ⁽¹⁾	176,0	
	BW				244,0 ⁽⁵⁾		247,0 ⁽⁸⁾		244,0 ⁽⁶⁾		241,0 ⁽⁵⁾	175,0	237,0 ⁽³⁾	176,0	
56	B				161,0 ⁽¹⁰⁾		163,0 ⁽¹⁰⁾		167,0 ⁽¹¹⁾		172,0 ⁽¹⁰⁾	141,0	178,0 ⁽¹⁾	158,0	
	BW				218,0 ⁽⁶⁾		225,0 ⁽⁸⁾		224,0 ⁽⁸⁾		223,0 ⁽¹⁾	141,0	217,0 ⁽³⁾	158,0	
60	B				139,0 ⁽⁸⁾		145,0 ⁽¹⁰⁾		148,0 ⁽¹⁰⁾		155,0 ⁽¹¹⁾		162,0 ⁽¹⁾	134,0	
	BW				197,0 ⁽⁸⁾		203,0 ⁽⁸⁾		206,0 ⁽¹⁰⁾		206,0 ⁽¹⁾		200,0 ⁽⁴⁾	135,0	
64	B				125,0 ⁽⁸⁾		128,0 ⁽¹⁰⁾		133,0 ⁽¹⁰⁾		136,0 ⁽¹⁰⁾		145,0 ⁽¹⁾		
	BW				180,0 ⁽⁸⁾		182,0 ⁽⁹⁾		188,0 ⁽¹⁰⁾		188,0 ⁽⁸⁾		185,0 ⁽⁶⁾		
68	B				112,0 ⁽⁸⁾		112,0 ⁽⁸⁾		118,0 ⁽¹⁰⁾		123,0 ⁽¹⁰⁾		129,0 ⁽¹⁾		
	BW				164,0 ⁽⁸⁾		164,0 ⁽⁸⁾		170,0 ⁽¹⁰⁾		172,0 ⁽⁹⁾		171,0 ⁽⁷⁾		
72	B						99,7 ⁽⁸⁾		102,0 ⁽⁸⁾		110,0 ⁽¹⁰⁾		113,0 ⁽¹⁾		
	BW						150,0 ⁽⁸⁾		151,0 ⁽⁸⁾		157,0 ⁽⁹⁾		157,0 ⁽⁷⁾		
76	B						87,6 ⁽⁸⁾		91,1 ⁽⁸⁾		97,0 ⁽¹⁰⁾		100,0 ⁽¹⁰⁾		
	BW						135,0 ⁽⁸⁾		138,0 ⁽⁸⁾		142,0 ⁽¹⁰⁾		143,0 ⁽⁸⁾		
80	B								80,4 ⁽⁸⁾		84,6 ⁽⁸⁾		88,9 ⁽¹⁰⁾		
	BW								125,0 ⁽⁸⁾		128,0 ⁽⁸⁾		130,0 ⁽⁸⁾		
84	B										75,1 ⁽⁸⁾		76,0 ⁽⁸⁾		
	BW										117,0 ⁽⁸⁾		118,0 ⁽⁸⁾		
88	B										65,6 ⁽⁸⁾		67,5 ⁽⁸⁾		
	BW										106,0 ⁽⁸⁾		108,0 ⁽⁸⁾		
92	B										56,1 ⁽⁶⁾		59,0 ⁽⁸⁾		
	BW										94,5 ⁽⁶⁾		98,0 ⁽⁸⁾		
96	B										48,8 ⁽⁶⁾		49,3 ⁽⁶⁾		
	BW										85,7 ⁽⁶⁾		86,6 ⁽⁶⁾		
100	B												42,6 ⁽⁶⁾		
	BW												78,6 ⁽⁶⁾		
104	B												35,9 ⁽⁶⁾		
	BW												70,7 ⁽⁶⁾		
108	B													34,0 ⁽⁷⁾	
	BW													67,3 ⁽⁷⁾	

1) 12° 2) 17° 3) 22° 4) 27° 5) 32° 6) 37° 7) 42° 8) 47° 9) 52° 10) 57° 11) 62°

PDW3B/PDW3BW

P 78

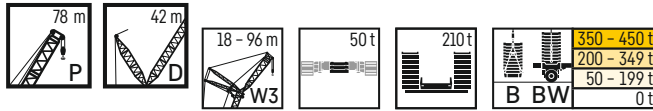

m	B BW	P 78 m													
		W3 60		W3 66		W3 72		W3 78		W3 84		W3 90		W3 96	
		87°/85	WVmax	87°/85	WVmax	87°/85	WVmax	87°/85	WVmax	87°/85	WVmax	87°/85	WVmax	87°/85	WVmax
26	B	255,0*	255,0*												
	BW	262,0*	262,0*												
28	B	246,0*	246,0*	227,0*	227,0*	209,0*	209,0*								
	BW	254,0*	254,0*	235,0*	235,0*	213,0*	213,0*								
30	B	257,0	257,0	220,0*	220,0*	204,0*	204,0*	186,0*	186,0*						
	BW	266,0	266,0	228,0*	228,0*	210,0*	210,0*	190,0*	190,0*						
32	B	250,0	250,0	230,0	230,0	198,0*	198,0*	182,0*	182,0*	167,0*	167,0*				
	BW	259,0	259,0	237,0	237,0	205,0*	205,0*	187,0*	187,0*	170,0*	170,0*				
34	B	242,0	242,0	225,0	225,0	206,0	206,0	177,0*	177,0*	163,0*	163,0*	150,0*	150,0*		
	BW	252,0	252,0	233,0	233,0	211,0	211,0	183,0*	183,0*	167,0*	167,0*	152,0*	152,0*		
36	B	234,0	236,0 ⁽²⁾	218,0	218,0	202,0	202,0	184,0	184,0	159,0*	159,0*	146,0*	146,0*	133,0*	133,0*
	BW	243,0	250,0 ⁽²⁾	227,0	227,0	208,0	208,0	189,0	189,0	164,0*	164,0*	150,0*	150,0*	135,0*	135,0*
38	B	225,0	229,0 ⁽²⁾	211,0	212,0 ⁽²⁾	197,0	197,0	180,0	180,0	164,0	164,0	143,0*	143,0*	131,0*	131,0*
	BW	235,0	250,0 ⁽²⁾	221,0	226,0 ⁽²⁾	205,0	205,0	186,0	186,0	169,0	169,0	147,0*	147,0*	134,0*	134,0*
40	B	217,0	223,0 ⁽²⁾	204,0	207,0 ⁽²⁾	190,0	192,0 ⁽²⁾	176,0	176,0	162,0	162,0	148,0	148,0	128,0*	128,0*
	BW	225,0	250,0 ⁽²⁾	214,0	225,0 ⁽²⁾	200,0	203,0 ⁽²⁾	183,0	183,0	166,0	166,0	151,0	151,0	132,0*	132,0*
44	B	201,0	210,0 ⁽²⁾	190,0	198,0 ⁽²⁾	179,0	184,0 ⁽²⁾	166,0	169,0 ⁽²⁾	155,0	155,0	143,0	143,0	130,0	130,0
	BW	208,0	250,0 ⁽²⁾	198,0	224,0 ⁽²⁾	188,0	202,0 ⁽²⁾	175,0	180,0 ⁽²⁾	161,0	162,0 ⁽²⁾	147,0	147,0	133,0	133,0
48	B	186,0	192,0 ⁽²⁾	176,0	188,0 ⁽²⁾	166,0	177,0 ⁽²⁾	156,0	164,0 ⁽²⁾	146,0	151,0 ⁽²⁾	136,0	138,0 ⁽²⁾	126,0	126,0
	BW	191,0	240,0 ⁽²⁾	183,0	223,0 ⁽²⁾	174,0	200,0 ⁽²⁾	165,0	179,0 ⁽²⁾	155,0	161,0 ⁽²⁾	143,0	145,0 ⁽²⁾	130,0	130,0
52	B	171,0	177,0 ⁽³⁾	164,0	171,0 ⁽³⁾	155,0	167,0 ⁽²⁾	146,0	159,0 ⁽²⁾	137,0	148,0 ⁽²⁾	128,0	135,0 ⁽²⁾	119,0	124,0 ⁽²⁾
	BW	174,0	226,0 ⁽²⁾	168,0	213,0 ⁽²⁾	161,0	197,0 ⁽²⁾	154,0	178,0 ⁽²⁾	145,0	160,0 ⁽²⁾	136,0	144,0 ⁽²⁾	126,0	129,0 ⁽²⁾
56	B	157,0	162,0 ⁽³⁾	151,0	158,0 ⁽⁴⁾	145,0	154,0 ⁽³⁾	136,0	148,0 ⁽²⁾	129,0	144,0 ⁽²⁾	120,0	133,0 ⁽²⁾	112,0	122,0 ⁽²⁾
	BW	157,0	211,0 ⁽²⁾	153,0	202,0 ⁽²⁾	149,0	190,0 ⁽²⁾	142,0	175,0 ⁽²⁾	136,0	158,0 ⁽²⁾	128,0	143,0 ⁽²⁾	120,0	128,0 ⁽²⁾
60	B	140,0	149,0 ⁽⁴⁾	138,0	146,0 ⁽³⁾	134,0	141,0 ⁽⁴⁾	127,0	137,0 ⁽³⁾	120,0	131,0 ⁽²⁾	112,0	128,0 ⁽²⁾	105,0	120,0 ⁽²⁾
	BW	141,0	196,0 ⁽²⁾	138,0	192,0 ⁽²⁾	135,0	183,0 ⁽²⁾	131,0	170,0 ⁽²⁾	126,0	155,0 ⁽²⁾	119,0	141,0 ⁽²⁾	113,0	126,0 ⁽²⁾
64	B	120,0	138,0 ⁽⁷⁾	125,0	135,0 ⁽⁶⁾	122,0	131,0 ⁽⁵⁾	118,0	126,0 ⁽⁴⁾	112,0	123,0 ⁽³⁾	105,0	116,0 ⁽³⁾	98,3	113,0 ⁽²⁾
	BW	121,0	181,0 ⁽³⁾	125,0	178,0 ⁽²⁾	122,0	175,0 ⁽²⁾	119,0	165,0 ⁽²⁾	117,0	151,0 ⁽²⁾	111,0	137,0 ⁽²⁾	105,0	124,0 ⁽²⁾
68	B	97,7	129,0 ⁽⁸⁾	109,0	125,0 ⁽⁷⁾	111,0	121,0 ⁽⁶⁾	107,0	117,0 ⁽⁵⁾	104,0	114,0 ⁽⁴⁾	97,3	108,0 ⁽³⁾	91,7	104,0 ⁽³⁾
	BW	97,3	166,0 ⁽³⁾	109,0	164,0 ⁽³⁾	112,0	162,0 ⁽²⁾	107,0	158,0 ⁽²⁾	105,0	147,0 ⁽²⁾	103,0	134,0 ⁽²⁾	98,5	121,0 ⁽²⁾
72	B		118,0 ⁽⁹⁾	91,7	116,0 ⁽⁸⁾	98,8	113,0 ⁽⁶⁾	98,7	109,0 ⁽⁵⁾	95,0	104,0 ⁽⁵⁾	90,0	101,0 ⁽⁴⁾	85,5	95,9 ⁽³⁾
	BW		154,0 ⁽⁴⁾	91,8	151,0 ⁽³⁾	98,8	149,0 ⁽²⁾	99,1	146,0 ⁽²⁾	95,8	140,0 ⁽²⁾	91,9	130,0 ⁽²⁾	90,7	118,0 ⁽²⁾
76	B		106,0 ⁽⁹⁾		107,0 ⁽⁹⁾	84,9	105,0 ⁽⁷⁾	88,4	102,0 ⁽⁶⁾	86,3	97,6 ⁽⁵⁾	83,1	92,2 ⁽⁵⁾	79,3	90,5 ⁽⁴⁾
	BW		141,0 ⁽⁴⁾		139,0 ⁽³⁾	85,3	136,0 ⁽²⁾	88,8	135,0 ⁽²⁾	88,1	130,0 ⁽²⁾	83,1	123,0 ⁽²⁾	82,1	115,0 ⁽²⁾
80	B		96,2 ⁽¹⁰⁾		97,2 ⁽⁹⁾	68,8	97,0 ⁽⁸⁾	77,7	93,9 ⁽⁷⁾	78,1	91,3 ⁽⁶⁾	75,1	86,3 ⁽⁵⁾	73,9	82,0 ⁽⁵⁾
	BW		129,0 ⁽⁵⁾		127,0 ⁽⁴⁾	68,7	125,0 ⁽³⁾	77,6	124,0 ⁽²⁾	79,2	120,0 ⁽²⁾	75,2	114,0 ⁽²⁾	74,1	108,0 ⁽²⁾
84	B		87,6 ⁽¹¹⁾		87,6 ⁽¹⁰⁾		87,8 ⁽⁹⁾	64,4	86,4 ⁽⁸⁾	69,8	83,0 ⁽⁷⁾	66,1	80,5 ⁽⁶⁾	65,5	76,9 ⁽⁵⁾
	BW		118,0 ⁽⁶⁾		116,0 ⁽⁴⁾		114,0 ⁽³⁾	64,6	112,0 ⁽²⁾	69,8	110,0 ⁽²⁾	69,0	106,0 ⁽²⁾	66,2	101,0 ⁽²⁾
88	B		78,2 ⁽¹¹⁾		80,7 ⁽¹¹⁾		79,6 ⁽⁹⁾	78,9 ⁽⁹⁾	78,9 ⁽⁹⁾	60,0	77,2 ⁽⁸⁾	59,5	72,4 ⁽⁶⁾	57,2	70,9 ⁽⁶⁾
	BW		109,0 ⁽⁷⁾		107,0 ⁽⁵⁾		105,0 ⁽⁴⁾	79,6 ⁽⁹⁾	103,0 ⁽³⁾	59,9	101,0 ⁽³⁾	61,8	97,7 ⁽²⁾	60,3	94,0 ⁽²⁾
92	B		68,8 ⁽¹¹⁾		72,3 ⁽¹¹⁾		72,8 ⁽¹⁰⁾	71,9 ⁽⁹⁾	71,9 ⁽⁹⁾	48,7	70,3 ⁽⁸⁾	52,6	65,6 ⁽⁷⁾	50,2	63,9 ⁽⁶⁾
	BW		102,0 ⁽⁸⁾		99,3 ⁽⁶⁾		96,8 ⁽⁵⁾	94,6 ⁽⁴⁾	94,6 ⁽⁴⁾	48,8	93,0 ⁽³⁾	53,9	89,4 ⁽²⁾	54,2	86,9 ⁽²⁾
96	B		58,2 ⁽⁹⁾		63,7 ⁽¹¹⁾		66,3 ⁽¹¹⁾	65,3 ⁽¹⁰⁾	65,3 ⁽¹⁰⁾		64,2 ⁽⁹⁾	44,1	60,8 ⁽⁸⁾	43,9	58,1 ⁽⁷⁾
	BW		95,2 ⁽⁹⁾		93,1 ⁽⁷⁾		90,1 ⁽⁵⁾	87,6 ⁽⁴⁾	87,6 ⁽⁴⁾		85,2 ⁽³⁾	44,3	82,4 ⁽³⁾	47,7	79,8 ⁽²⁾
100	B		50,8 ⁽⁹⁾		55,2 ⁽¹¹⁾		58,4 ⁽¹¹⁾	60,8 ⁽¹¹⁾	60,8 ⁽¹¹⁾		58,4 ⁽⁹⁾		55,7 ⁽⁹⁾	39,1	53,9 ⁽⁸⁾
	BW		86,7 ⁽⁹⁾		87,4 ⁽⁹⁾		84,4 ⁽⁶⁾	81,7 ⁽⁵⁾	81,7 ⁽⁵⁾		79,1 ⁽⁴⁾		76,0 ⁽³⁾	39,9	74,0 ⁽³⁾
104	B		43,5 ⁽⁹⁾		46,3 ⁽⁹⁾		50,5 ⁽¹¹⁾	53,5 ⁽¹¹⁾	53,5 ⁽¹¹⁾		54,1 ⁽¹⁰⁾		50,7 ⁽⁹⁾	31,2	49,4 ⁽⁸⁾
	BW		78,1 ⁽⁹⁾		80,6 ⁽⁹⁾		79,4 ⁽⁸⁾	76,4 ⁽⁶⁾	76,4 ⁽⁶⁾		73,5 ⁽⁵⁾		70,5 ⁽⁴⁾	31,2	68,2 ⁽³⁾
108	B		35,2 ⁽⁷⁾		39,6 ⁽⁹⁾		41,3 ⁽⁹⁾	46,3 ⁽¹¹⁾	46,3 ⁽¹¹⁾		48,6 ⁽¹¹⁾		46,6 ⁽¹⁰⁾		44,6 ⁽⁹⁾
	BW		68,5 ⁽⁷⁾		72,8 ⁽⁹⁾		74,4 ⁽⁹⁾	72,0 ⁽⁷⁾	72,0 ⁽⁷⁾		69,0 ⁽⁵⁾		65,5 ⁽⁴⁾		62,9 ⁽⁴⁾
112	B		29,4 ⁽⁷⁾		32,8 ⁽⁹⁾		34,9 ⁽⁹⁾	39,0 ⁽¹¹⁾	39,0 ⁽¹¹⁾		41,6 ⁽¹¹⁾		42,5 ⁽¹¹⁾		40,0 ⁽¹⁰⁾
	BW		61,6 ⁽⁷⁾		64,9 ⁽⁹⁾		67,1 ⁽⁹⁾	67,9 ⁽⁹⁾	67,9 ⁽⁹⁾		64,7 ⁽⁶⁾		61,4 ⁽⁵⁾		58,6 ⁽⁴⁾
116	B		23,6 ⁽⁷⁾		25,4 ⁽⁷⁾		28,5 ⁽⁹⁾	30,4 ⁽⁹⁾	30,4 ⁽⁹⁾		34,7 ⁽¹¹⁾		36,1 ⁽¹¹⁾		36,5 ⁽¹¹⁾
	BW		54,8 ⁽⁷⁾		56,7 ⁽⁷⁾		59,8 ⁽⁹⁾	62,0 ⁽⁹⁾	62,0 ⁽⁹⁾		61,0 ⁽⁸⁾		57,6 ⁽⁶⁾		54,6 ⁽⁵⁾
120	B				19,9 ⁽⁷⁾		20,5 ⁽⁷⁾	24,4 ⁽⁹⁾	24,4 ⁽⁹⁾		25,7 ⁽⁹⁾		29,7 ⁽¹¹⁾		32,0 ⁽¹¹⁾
	BW				50,4 ⁽⁷⁾		51,4 ⁽⁷⁾	55,3 ⁽⁹⁾	55,3 ⁽⁹⁾		56,5 ⁽⁹⁾		53,8 ⁽⁷⁾		50,8 ⁽⁶⁾
124	B						15,4 ⁽⁷⁾	18,4 ⁽⁹⁾	18,4 ⁽⁹⁾		20,0 ⁽⁹⁾		23,2 ⁽¹¹⁾		25,7 ⁽¹¹⁾
	BW						45,5 ⁽⁷⁾	48,6 ⁽⁹⁾	48,6 ⁽⁹⁾		50,3 ⁽⁹⁾		50,2 ⁽⁹⁾		47,0 ⁽⁶⁾
128	B						10,2 ⁽⁷⁾				14,4 ⁽⁹⁾				19,5 ⁽¹¹⁾
	BW						39,5 ⁽⁷⁾	41,2 ⁽⁷⁾	41,2 ⁽⁷⁾		44,1 ⁽⁹⁾		45,0 ⁽⁹⁾		42,2 ⁽⁷⁾
132	B														
	BW							35,6 ⁽⁷⁾	35,6 ⁽⁷⁾		36,6 ⁽⁷⁾		39,3 ⁽⁹⁾		38,5 ⁽⁹⁾
136	B														
	BW										31,3 ⁽⁷⁾		33,6 ⁽⁹⁾		33,7 ⁽⁹⁾
140	B														
	BW										26,1 ⁽⁷⁾		26,9 ⁽⁷⁾		28,9 ⁽⁹⁾
144	B														
	BW												22,0 ⁽⁷⁾		22,8 ⁽⁷⁾
148	B														
	BW														18,1 ⁽⁷⁾
152	B														
	BW														13,4 ⁽⁷⁾

1) 12° 2) 17° 3) 22° 4) 27° 5) 32° 6) 37° 7) 42° 8) 47° 9) 52° 10) 57° 11) 62°

PDW3B/PDW3BW

P 84

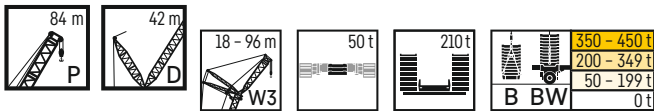

m		P 84 m													
		W3 18 m		W3 24 m		W3 30 m		W3 36 m		W3 42 m		W3 48 m		W3 54 m	
		87°/85	WVmax	87°/85	WVmax	87°/85	WVmax	87°/85	WVmax	87°/85	WVmax	87°/85	WVmax	87°/85	WVmax
14	B	491,0*	491,0*												
	BW	500,0*	500,0*												
16	B	468,0*	468,0*	438,0*	438,0*										
	BW	479,0*	479,0*	446,0*	446,0*										
18	B	488,0	488,0	418,0*	418,0*	393,0*	402,0 ⁽¹⁾	366,0*	366,0*						
	BW	501,0	501,0	424,0*	424,0*	401,0*	410,0 ⁽¹⁾	373,0*	373,0*						
20	B	467,0	467,0	439,0	439,0	377,0*	404,0 ⁽¹⁾	353,0*	364,0 ⁽¹⁾	330,0*	330,0*				
	BW	473,0	485,0 ⁽²⁾	447,0	447,0	385,0*	414,0 ⁽¹⁾	361,0*	373,0 ⁽¹⁾	337,0*	337,0*				
22	B	439,0	443,0 ⁽³⁾	418,0	420,0 ⁽²⁾	397,0	397,0	339,0*	366,0 ⁽¹⁾	319,0*	331,0 ⁽¹⁾	297,0*	297,0*		
	BW	443,0	475,0 ⁽²⁾	420,0	429,0 ⁽²⁾	408,0	411,0 ⁽¹⁾	347,0*	376,0 ⁽¹⁾	326,0*	328,0 ⁽¹⁾	304,0*	304,0*		
24	B	407,0	419,0 ⁽²⁾	394,0	400,0 ⁽²⁾	380,0	380,0	357,0	358,0 ⁽¹⁾	334,0	334,0	287,0*	290,0 ⁽¹⁾	267,0*	267,0*
	BW	410,0	465,0 ⁽²⁾	396,0	422,0 ⁽²⁾	394,0	405,0 ⁽¹⁾	369,0	373,0 ⁽¹⁾	320,0	321,0 ⁽¹⁾	295,0*	296,0 ⁽¹⁾	275,0*	275,0*
26	B	352,0	395,0 ⁽²⁾	369,0	380,0 ⁽²⁾	363,0	365,0 ⁽¹⁾	342,0	345,0 ⁽¹⁾	321,0	323,0 ⁽¹⁾	275,0*	283,0 ⁽¹⁾	259,0*	259,0*
	BW	352,0	456,0 ⁽²⁾	373,0	414,0 ⁽²⁾	378,0	399,0 ⁽¹⁾	356,0	369,0 ⁽¹⁾	335,0	335,0	284,0*	288,0 ⁽¹⁾	266,0*	266,0*
28	B	262,0	371,0 ⁽²⁾	342,0	361,0 ⁽²⁾	346,0	349,0 ⁽¹⁾	327,0	332,0 ⁽¹⁾	309,0	312,0 ⁽¹⁾	289,0	289,0	249,0*	249,0*
	BW	263,0	444,0 ⁽²⁾	343,0	406,0 ⁽²⁾	359,0	393,0 ⁽¹⁾	341,0	365,0 ⁽¹⁾	321,0	322,0 ⁽²⁾	301,0	301,0	256,0*	256,0*
30	B		347,0 ⁽³⁾	308,0	341,0 ⁽²⁾	329,0	334,0 ⁽¹⁾	312,0	320,0 ⁽¹⁾	296,0	301,0 ⁽¹⁾	279,0	279,0	262,0	262,0
	BW		426,0 ⁽⁴⁾	307,0	399,0 ⁽²⁾	339,0	387,0 ⁽¹⁾	324,0	361,0 ⁽¹⁾	308,0	320,0 ⁽²⁾	290,0	290,0	272,0	272,0
32	B		325,0 ⁽⁶⁾	271,0	320,0 ⁽²⁾	312,0	316,0 ⁽¹⁾	298,0	307,0 ⁽¹⁾	284,0	290,0 ⁽¹⁾	268,0	270,0 ⁽²⁾	253,0	253,0
	BW		406,0 ⁽⁴⁾	270,0	384,0 ⁽²⁾	321,0	375,0 ⁽¹⁾	306,0	357,0 ⁽¹⁾	293,0	318,0 ⁽²⁾	278,0	288,0 ⁽²⁾	262,0	262,0
34	B		306,0 ⁽⁸⁾	212,0	301,0 ⁽⁴⁾	296,0	297,0 ⁽⁵⁾	285,0	292,0 ⁽¹⁾	272,0	279,0 ⁽¹⁾	257,0	262,0 ⁽²⁾	244,0	246,0 ⁽²⁾
	BW		386,0 ⁽⁴⁾	210,0	369,0 ⁽²⁾	305,0	361,0 ⁽¹⁾	291,0	348,0 ⁽¹⁾	279,0	315,0 ⁽²⁾	266,0	286,0 ⁽²⁾	253,0	259,0 ⁽²⁾
36	B		288,0 ⁽⁹⁾		284,0 ⁽⁶⁾	280,0	282,0 ⁽⁶⁾	270,0	275,0 ⁽²⁾	260,0	268,0 ⁽¹⁾	247,0	253,0 ⁽²⁾	235,0	239,0 ⁽²⁾
	BW		367,0 ⁽⁵⁾		354,0 ⁽²⁾	287,0	347,0 ⁽¹⁾	276,0	335,0 ⁽¹⁾	266,0	313,0 ⁽²⁾	254,0	285,0 ⁽²⁾	242,0	258,0 ⁽²⁾
38	B		269,0 ⁽⁹⁾		268,0 ⁽⁷⁾	249,0	268,0 ⁽⁸⁾	256,0	260,0 ⁽³⁾	248,0	257,0 ⁽¹⁾	237,0	244,0 ⁽²⁾	226,0	232,0 ⁽²⁾
	BW		348,0 ⁽²⁾		339,0 ⁽²⁾	249,0	334,0 ⁽⁴⁾	264,0	323,0 ⁽¹⁾	254,0	311,0 ⁽²⁾	243,0	284,0 ⁽²⁾	232,0	257,0 ⁽²⁾
40	B		251,0 ⁽⁹⁾		255,0 ⁽⁹⁾	196,0	254,0 ⁽⁸⁾	245,0	247,0 ⁽⁵⁾	237,0	247,0 ⁽¹⁾	227,0	236,0 ⁽²⁾	217,0	226,0 ⁽²⁾
	BW		331,0 ⁽²⁾		324,0 ⁽²⁾	196,0	322,0 ⁽⁵⁾	253,0	311,0 ⁽¹⁾	241,0	301,0 ⁽²⁾	232,0	282,0 ⁽²⁾	222,0	256,0 ⁽²⁾
44	B		220,0 ⁽⁹⁾		226,0 ⁽⁹⁾		227,0 ⁽⁹⁾	211,0	224,0 ⁽⁹⁾	216,0	225,0 ⁽¹⁾	207,0	216,0 ⁽¹⁾	200,0	212,0 ⁽²⁾
	BW		299,0 ⁽⁷⁾		295,0 ⁽²⁾		296,0 ⁽⁸⁾	213,0	287,0 ⁽⁴⁾	221,0	279,0 ⁽²⁾	212,0	268,0 ⁽²⁾	204,0	254,0 ⁽²⁾
48	B		197,0 ⁽⁹⁾		198,0 ⁽¹⁰⁾		204,0 ⁽¹¹⁾		204,0 ⁽⁹⁾	198,0	203,0 ⁽¹⁾	191,0	201,0 ⁽¹⁾	184,0	194,0 ⁽³⁾
	BW		270,0 ⁽⁸⁾		268,0 ⁽⁶⁾		269,0 ⁽⁸⁾		262,0 ⁽⁵⁾	203,0	256,0 ⁽³⁾	195,0	249,0 ⁽²⁾	187,0	239,0 ⁽²⁾
52	B		174,0 ⁽⁹⁾		178,0 ⁽¹⁰⁾		181,0 ⁽¹¹⁾		185,0 ⁽¹⁰⁾	145,0	183,0 ⁽⁹⁾	175,0	186,0 ⁽¹⁾	169,0	177,0 ⁽⁴⁾
	BW		241,0 ⁽⁸⁾		243,0 ⁽⁶⁾		242,0 ⁽⁸⁾		240,0 ⁽⁸⁾	145,0	236,0 ⁽⁴⁾	177,0	231,0 ⁽²⁾	172,0	225,0 ⁽²⁾
56	B				159,0 ⁽¹⁰⁾		159,0 ⁽¹⁰⁾		166,0 ⁽¹¹⁾		168,0 ⁽¹⁰⁾	148,0	171,0 ⁽¹⁾	157,0	163,0 ⁽⁵⁾
	BW				219,0 ⁽⁷⁾		221,0 ⁽⁹⁾		220,0 ⁽⁸⁾		217,0 ⁽⁵⁾	148,0	213,0 ⁽³⁾	159,0	210,0 ⁽²⁾
60	B				140,0 ⁽¹⁰⁾		143,0 ⁽¹⁰⁾		145,0 ⁽¹⁰⁾		153,0 ⁽¹¹⁾		156,0 ⁽¹⁾	139,0	150,0 ⁽⁷⁾
	BW				196,0 ⁽⁸⁾		201,0 ⁽¹⁰⁾		202,0 ⁽⁹⁾		200,0 ⁽⁷⁾		196,0 ⁽⁴⁾	138,0	194,0 ⁽³⁾
64	B						126,0 ⁽¹⁰⁾		130,0 ⁽¹⁰⁾		136,0 ⁽¹¹⁾		141,0 ⁽¹⁾	107,0	139,0 ⁽⁸⁾
	BW						181,0 ⁽¹⁰⁾		185,0 ⁽¹⁰⁾		185,0 ⁽⁸⁾		182,0 ⁽⁶⁾	106,0	179,0 ⁽³⁾
68	B						108,0 ⁽⁸⁾		116,0 ⁽¹⁰⁾		120,0 ⁽¹⁰⁾		126,0 ⁽¹⁾		129,0 ⁽¹⁰⁾
	BW						160,0 ⁽⁸⁾		168,0 ⁽¹⁰⁾		171,0 ⁽¹⁰⁾		169,0 ⁽⁸⁾		166,0 ⁽⁵⁾
72	B						96,8 ⁽⁸⁾		102,0 ⁽¹⁰⁾		108,0 ⁽¹⁰⁾		112,0 ⁽¹⁾		117,0 ⁽¹¹⁾
	BW						146,0 ⁽⁸⁾		151,0 ⁽¹⁰⁾		156,0 ⁽¹⁰⁾		156,0 ⁽⁸⁾		154,0 ⁽⁶⁾
76	B						85,6 ⁽⁸⁾		87,9 ⁽⁸⁾		95,4 ⁽¹⁰⁾		99,0 ⁽¹⁰⁾		105,0 ⁽¹¹⁾
	BW						133,0 ⁽⁸⁾		135,0 ⁽⁸⁾		142,0 ⁽¹⁰⁾		143,0 ⁽⁹⁾		142,0 ⁽⁷⁾
80	B						74,4 ⁽⁸⁾		78,0 ⁽⁸⁾		81,2 ⁽⁸⁾		87,8 ⁽¹⁰⁾		93,8 ⁽¹¹⁾
	BW						119,0 ⁽⁸⁾		123,0 ⁽⁸⁾		126,0 ⁽⁸⁾		130,0 ⁽⁹⁾		131,0 ⁽⁷⁾
84	B								68,1 ⁽⁸⁾		72,3 ⁽⁸⁾		76,7 ⁽¹⁰⁾		83,7 ⁽¹¹⁾
	BW								111,0 ⁽⁸⁾		115,0 ⁽⁸⁾		118,0 ⁽¹⁰⁾		120,0 ⁽⁸⁾
88	B										63,4 ⁽⁸⁾		65,3 ⁽⁸⁾		73,7 ⁽¹¹⁾
	BW										104,0 ⁽⁸⁾		106,0 ⁽⁸⁾		110,0 ⁽⁹⁾
92	B										54,4 ⁽⁸⁾		57,2 ⁽⁸⁾		62,0 ⁽⁹⁾
	BW										93,4 ⁽⁸⁾		96,3 ⁽⁸⁾		99,9 ⁽⁹⁾
96	B										45,9 ⁽⁶⁾		49,1 ⁽⁸⁾		54,4 ⁽⁹⁾
	BW										83,3 ⁽⁶⁾		86,6 ⁽⁸⁾		91,0 ⁽⁹⁾
100	B										39,1 ⁽⁶⁾				46,8 ⁽⁹⁾
	BW										75,1 ⁽⁶⁾				82,1 ⁽⁹⁾
104	B														39,2 ⁽⁹⁾
	BW														73,2 ⁽⁹⁾
108	B														31,8 ⁽⁷⁾
	BW														64,6 ⁽⁷⁾
112	B														25,9 ⁽⁷⁾
	BW														57,6 ⁽⁷⁾

1) 12° 2) 17° 3) 22° 4) 27° 5) 32° 6) 37° 7) 42° 8) 47° 9) 52° 10) 57° 11) 62°

PDW3B/PDW3BW

P 84

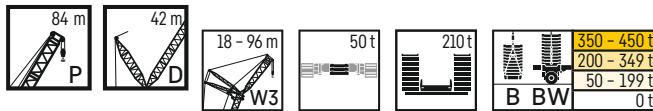

m		P 84 m													
		W3 60		W3 66		W3 72		W3 78		W3 84		W3 90		W3 96	
		87°/85	WVmax	87°/85	WVmax	87°/85	WVmax	87°/85	WVmax	87°/85	WVmax	87°/85	WVmax	87°/85	WVmax
26	B	240,0*	240,0*												
	BW	247,0*	247,0*												
28	B	232,0*	232,0*	216,0*	216,0*	173,0*	173,0*								
	BW	239,0*	239,0*	222,0*	222,0*	181,0*	181,0*								
30	B	243,0	243,0	209,0*	209,0*	193,0*	193,0*	178,0*	178,0*						
	BW	252,0	252,0	216,0*	216,0*	199,0*	199,0*	181,0*	181,0*						
32	B	235,0	235,0	219,0	219,0	187,0*	187,0*	174,0*	174,0*	158,0*	158,0*				
	BW	245,0	245,0	226,0	226,0	194,0*	194,0*	179,0*	179,0*	162,0*	162,0*				
34	B	228,0	228,0	213,0	213,0	196,0	196,0	169,0*	169,0*	154,0*	154,0*	142,0*	142,0*		
	BW	237,0	237,0	222,0	222,0	202,0	202,0	175,0*	175,0*	159,0*	159,0*	146,0*	146,0*		
36	B	220,0	222,0 ⁽²⁾	207,0	207,0	191,0	191,0	176,0	176,0	150,0*	150,0*	138,0*	138,0*	127,0*	127,0*
	BW	229,0	234,0 ⁽²⁾	216,0	216,0	199,0	199,0	181,0	181,0	155,0*	155,0*	143,0*	143,0*	130,0*	130,0*
38	B	213,0	216,0 ⁽²⁾	200,0	201,0 ⁽²⁾	186,0	186,0	173,0	173,0	157,0	157,0	135,0*	135,0*	124,0*	124,0*
	BW	220,0	233,0 ⁽²⁾	209,0	212,0 ⁽²⁾	194,0	194,0	179,0	179,0	161,0	161,0	139,0*	139,0*	128,0*	128,0*
40	B	205,0	211,0 ⁽²⁾	194,0	197,0 ⁽²⁾	180,0	180,0	168,0	168,0	154,0	154,0	141,0	141,0	121,0*	121,0*
	BW	211,0	232,0 ⁽²⁾	201,0	211,0 ⁽²⁾	188,0	190,0 ⁽²⁾	176,0	176,0	159,0	159,0	145,0	145,0	125,0*	125,0*
44	B	190,0	200,0 ⁽²⁾	180,0	189,0 ⁽²⁾	168,0	174,0 ⁽²⁾	159,0	161,0 ⁽²⁾	146,0	146,0	135,0	135,0	124,0	124,0
	BW	195,0	230,0 ⁽²⁾	186,0	210,0 ⁽²⁾	176,0	189,0 ⁽²⁾	166,0	172,0 ⁽²⁾	154,0	155,0 ⁽²⁾	141,0	141,0	128,0	128,0
48	B	175,0	186,0 ⁽²⁾	167,0	180,0 ⁽²⁾	157,0	167,0 ⁽²⁾	148,0	156,0 ⁽²⁾	138,0	142,0 ⁽²⁾	128,0	129,0 ⁽²⁾	118,0	118,0
	BW	179,0	226,0 ⁽²⁾	172,0	209,0 ⁽²⁾	163,0	187,0 ⁽²⁾	155,0	170,0 ⁽²⁾	145,0	153,0 ⁽²⁾	135,0	138,0 ⁽²⁾	124,0	124,0
52	B	161,0	171,0 ⁽³⁾	155,0	166,0 ⁽³⁾	146,0	161,0 ⁽³⁾	139,0	152,0 ⁽³⁾	129,0	139,0 ⁽³⁾	120,0	127,0 ⁽³⁾	112,0	116,0 ⁽³⁾
	BW	165,0	214,0 ⁽³⁾	159,0	203,0 ⁽³⁾	151,0	186,0 ⁽³⁾	145,0	169,0 ⁽³⁾	136,0	151,0 ⁽³⁾	128,0	136,0 ⁽³⁾	119,0	123,0 ⁽³⁾
56	B	150,0	157,0 ⁽⁴⁾	144,0	153,0 ⁽⁴⁾	136,0	146,0 ⁽⁴⁾	130,0	144,0 ⁽⁴⁾	121,0	136,0 ⁽⁴⁾	112,0	125,0 ⁽⁴⁾	106,0	115,0 ⁽⁴⁾
	BW	153,0	203,0 ⁽⁴⁾	147,0	194,0 ⁽⁴⁾	140,0	180,0 ⁽⁴⁾	134,0	166,0 ⁽⁴⁾	126,0	150,0 ⁽⁴⁾	119,0	135,0 ⁽⁴⁾	112,0	122,0 ⁽⁴⁾
60	B	138,0	146,0 ⁽⁵⁾	133,0	142,0 ⁽⁵⁾	127,0	135,0 ⁽⁵⁾	121,0	133,0 ⁽⁵⁾	113,0	126,0 ⁽⁵⁾	105,0	122,0 ⁽⁵⁾	98,5	113,0 ⁽⁵⁾
	BW	142,0	191,0 ⁽⁵⁾	136,0	186,0 ⁽⁵⁾	129,0	174,0 ⁽⁵⁾	125,0	162,0 ⁽⁵⁾	118,0	147,0 ⁽⁵⁾	111,0	134,0 ⁽⁵⁾	105,0	121,0 ⁽⁵⁾
64	B	123,0	134,0 ⁽⁶⁾	123,0	132,0 ⁽⁶⁾	117,0	126,0 ⁽⁶⁾	112,0	122,0 ⁽⁶⁾	105,0	118,0 ⁽⁶⁾	97,8	111,0 ⁽⁶⁾	91,7	109,0 ⁽⁶⁾
	BW	123,0	176,0 ⁽⁶⁾	127,0	174,0 ⁽⁶⁾	120,0	169,0 ⁽⁶⁾	115,0	158,0 ⁽⁶⁾	109,0	144,0 ⁽⁶⁾	103,0	130,0 ⁽⁶⁾	98,0	119,0 ⁽⁶⁾
68	B	101,0	125,0 ⁽⁶⁾	112,0	123,0 ⁽⁶⁾	109,0	117,0 ⁽⁶⁾	105,0	113,0 ⁽⁶⁾	97,6	108,0 ⁽⁶⁾	91,2	104,0 ⁽⁶⁾	85,6	97,8 ⁽⁶⁾
	BW	101,0	163,0 ⁽⁶⁾	113,0	162,0 ⁽⁶⁾	112,0	157,0 ⁽⁶⁾	107,0	154,0 ⁽⁶⁾	101,0	140,0 ⁽⁶⁾	96,2	127,0 ⁽⁶⁾	91,1	116,0 ⁽⁶⁾
72	B		116,0 ⁽⁶⁾	96,2	114,0 ⁽⁷⁾	99,1	109,0 ⁽⁶⁾	97,0	106,0 ⁽⁶⁾	90,7	99,9 ⁽⁶⁾	85,4	95,3 ⁽⁶⁾	79,9	91,9 ⁽⁶⁾
	BW		152,0 ⁽⁶⁾	95,4	150,0 ⁽⁶⁾	100,0	146,0 ⁽⁶⁾	101,0	143,0 ⁽⁶⁾	94,3	135,0 ⁽⁶⁾	88,9	124,0 ⁽⁶⁾	84,5	113,0 ⁽⁶⁾
76	B		106,0 ⁽¹⁰⁾	73,3	106,0 ⁽⁹⁾	86,9	102,0 ⁽⁷⁾	88,2	99,6 ⁽⁶⁾	83,9	93,9 ⁽⁶⁾	79,3	87,8 ⁽⁴⁾	74,6	85,2 ⁽⁴⁾
	BW		140,0 ⁽⁶⁾	73,2	138,0 ⁽⁴⁾	87,0	135,0 ⁽⁵⁾	91,8	134,0 ⁽⁵⁾	88,1	126,0 ⁽³⁾	82,8	119,0 ⁽²⁾	78,6	110,0 ⁽²⁾
80	B		95,0 ⁽¹¹⁾		97,2 ⁽¹⁰⁾	71,1	95,2 ⁽⁸⁾	79,9	93,0 ⁽⁷⁾	75,9	87,7 ⁽⁶⁾	73,5	82,7 ⁽⁵⁾	68,8	77,8 ⁽⁴⁾
	BW		129,0 ⁽⁶⁾		127,0 ⁽⁴⁾	71,4	124,0 ⁽³⁾	80,9	124,0 ⁽³⁾	80,3	119,0 ⁽³⁾	75,9	111,0 ⁽²⁾	73,0	105,0 ⁽²⁾
84	B		85,5 ⁽¹¹⁾		87,8 ⁽¹⁰⁾		88,0 ⁽⁹⁾	67,6	87,3 ⁽⁸⁾	68,0	81,5 ⁽⁷⁾	64,8	76,9 ⁽⁴⁾	63,2	73,6 ⁽⁵⁾
	BW		118,0 ⁽⁶⁾		117,0 ⁽⁵⁾		114,0 ⁽⁴⁾	67,5	114,0 ⁽³⁾	71,1	110,0 ⁽³⁾	68,4	103,0 ⁽³⁾	66,9	99,2 ⁽³⁾
88	B		76,4 ⁽¹¹⁾		79,1 ⁽¹¹⁾		79,0 ⁽¹⁰⁾	51,6	80,5 ⁽⁹⁾	60,4	76,0 ⁽⁸⁾	57,9	71,0 ⁽⁷⁾	55,9	68,0 ⁽⁶⁾
	BW		108,0 ⁽⁶⁾		107,0 ⁽⁵⁾		105,0 ⁽⁴⁾	51,7	104,0 ⁽³⁾	61,2	101,0 ⁽³⁾	61,9	96,1 ⁽³⁾	59,8	92,7 ⁽³⁾
92	B		67,2 ⁽¹¹⁾		71,1 ⁽¹¹⁾		71,0 ⁽¹⁰⁾		72,1 ⁽⁹⁾	50,4	69,9 ⁽⁹⁾	51,8	65,6 ⁽⁷⁾	49,0	62,2 ⁽⁷⁾
	BW		99,8 ⁽⁶⁾		98,6 ⁽⁶⁾		95,4 ⁽⁵⁾		94,9 ⁽⁴⁾	50,4	92,5 ⁽³⁾	54,3	88,8 ⁽³⁾	52,7	86,1 ⁽³⁾
96	B		58,1 ⁽¹¹⁾		62,8 ⁽¹¹⁾		64,4 ⁽¹¹⁾		64,9 ⁽¹⁰⁾		63,6 ⁽⁹⁾	45,5	61,4 ⁽⁸⁾	43,0	58,5 ⁽⁷⁾
	BW		92,0 ⁽⁹⁾		91,5 ⁽⁸⁾		87,9 ⁽⁶⁾		86,9 ⁽⁴⁾		84,2 ⁽⁴⁾	45,9	81,4 ⁽³⁾	46,8	79,5 ⁽³⁾
100	B		48,5 ⁽⁹⁾		54,4 ⁽¹¹⁾		56,5 ⁽¹¹⁾		58,8 ⁽¹¹⁾		56,6 ⁽¹⁰⁾	33,1	56,1 ⁽⁹⁾	38,2	55,0 ⁽⁸⁾
	BW		84,2 ⁽⁹⁾		84,9 ⁽⁸⁾		81,7 ⁽⁷⁾		80,2 ⁽⁵⁾		77,3 ⁽⁴⁾	33,0	74,1 ⁽⁴⁾	40,6	72,9 ⁽³⁾
104	B		41,4 ⁽⁹⁾		44,3 ⁽⁹⁾		48,7 ⁽¹¹⁾		52,5 ⁽¹¹⁾		50,9 ⁽¹⁰⁾		49,6 ⁽¹⁰⁾	32,6	50,5 ⁽⁹⁾
	BW		76,0 ⁽⁹⁾		78,8 ⁽⁹⁾		76,2 ⁽⁸⁾		74,3 ⁽⁶⁾		71,1 ⁽⁵⁾		68,2 ⁽⁴⁾	32,7	66,2 ⁽³⁾
108	B		34,3 ⁽⁹⁾		37,6 ⁽⁹⁾		40,9 ⁽¹¹⁾		45,1 ⁽¹¹⁾		46,3 ⁽¹¹⁾		44,2 ⁽¹⁰⁾		44,0 ⁽⁹⁾
	BW		67,8 ⁽⁹⁾		71,3 ⁽⁹⁾		71,0 ⁽⁹⁾		69,1 ⁽⁷⁾		65,6 ⁽⁶⁾		62,5 ⁽⁵⁾		60,8 ⁽⁴⁾
112	B		26,0 ⁽⁷⁾		31,0 ⁽⁹⁾		31,7 ⁽⁹⁾		37,7 ⁽¹¹⁾		39,4 ⁽¹¹⁾		39,8 ⁽¹¹⁾		38,7 ⁽¹⁰⁾
	BW		58,9 ⁽⁷⁾		63,8 ⁽⁹⁾		64,9 ⁽⁹⁾		64,9 ⁽⁸⁾		61,1 ⁽⁶⁾		57,9 ⁽⁵⁾		55,6 ⁽⁴⁾
116	B		20,4 ⁽⁷⁾		24,4 ⁽⁹⁾		25,5 ⁽⁹⁾		28,1 ⁽⁹⁾		32,4 ⁽¹¹⁾		34,0 ⁽¹¹⁾		33,7 ⁽¹¹⁾
	BW		52,4 ⁽⁷⁾		56,2 ⁽⁹⁾		57,9 ⁽⁹⁾		60,6 ⁽⁹⁾		57,2 ⁽⁷⁾		53,8 ⁽⁶⁾		51,3 ⁽⁵⁾
120	B		14,9 ⁽⁷⁾		17,2 ⁽⁷⁾		19,4 ⁽⁹⁾		22,3 ⁽⁹⁾		25,5 ⁽¹¹⁾		27,6 ⁽¹¹⁾		29,6 ⁽¹¹⁾
	BW		45,9 ⁽⁷⁾		48,5 ⁽⁷⁾		50,9 ⁽⁹⁾		54,0 ⁽⁹⁾		53,7 ⁽⁹⁾		50,0 ⁽⁷⁾		47,3 ⁽⁵⁾
124	B				11,9 ⁽⁷⁾				16,5 ⁽⁹⁾				21,1 ⁽¹¹⁾		23,5 ⁽¹¹⁾
	BW				42,5 ⁽⁷⁾		43,0 ⁽⁷⁾		47,5 ⁽⁹⁾		48,5 ⁽⁹⁾		47,0 ⁽⁸⁾		44,1 ⁽⁶⁾
128	B								10,7 ⁽⁹⁾						17,4 ⁽¹¹⁾
	BW						37,3 ⁽⁷⁾		41,0 ⁽⁹⁾		42,4 ⁽⁹⁾		43,4 ⁽⁹⁾		41,1 ⁽⁷⁾
132	B														11,2 ⁽¹¹⁾
	BW						31,7 ⁽⁷⁾		34,0 ⁽⁷⁾		36,3 ⁽⁹⁾		37,7 ⁽⁹⁾		38,3 ⁽⁹⁾
136	B														
	BW								28,7 ⁽⁷⁾		29,0 ⁽⁷⁾		32,0 ⁽⁹⁾		33,6 ⁽⁹⁾
140	B														
	BW										24,1 ⁽⁷⁾		26,3 ⁽⁹⁾		28,2 ⁽⁹⁾
144	B														
	BW										19,1 ⁽⁷⁾		19,8 ⁽⁷⁾		22,8 ⁽⁹⁾
148	B														
	BW												15,1 ⁽⁹⁾		12,1 ⁽⁴⁾
152	B														
	BW														8,0 ⁽⁴⁾

1) 12° 2) 17° 3) 22° 4) 27° 5) 32° 6) 37° 7) 42° 8) 47° 9) 52° 10) 57° 11) 62°

PDW3B/PDW3BW

P 90

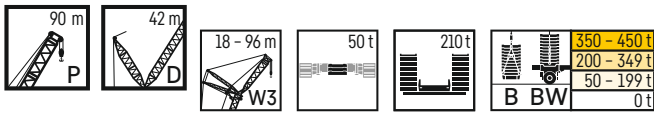

m	B BW	P 90 m													
		W3 18 m		W3 24 m		W3 30 m		W3 36 m		W3 42 m		W3 48 m		W3 54 m	
		87°/85	WVmax	87°/85	WVmax	87°/85	WVmax	87°/85	WVmax	87°/85	WVmax	87°/85	WVmax	87°/85	WVmax
16	B	433,0*	433,0*	403,0*	403,0*										
	BW	442,0*	442,0*	410,0*	410,0*										
18	B	451,0	451,0	386,0*	386,0*	362,0*	362,0*								
	BW	463,0	463,0	392,0*	392,0*	369,0*	369,0*								
20	B	433,0	433,0	404,0	404,0	348,0*	368,0 ⁽¹⁾	325,0*	332,0 ⁽¹⁾	303,0*	303,0*				
	BW	440,0	447,0 ⁽²⁾	414,0	414,0	355,0*	378,0 ⁽¹⁾	331,0*	339,0 ⁽¹⁾	309,0*	309,0*				
22	B	412,0	414,0 ⁽²⁾	389,0	389,0	366,0	366,0	313,0*	333,0 ⁽¹⁾	294,0*	302,0 ⁽¹⁾	272,0*	272,0*		
	BW	414,0	440,0 ⁽²⁾	391,0	394,0 ⁽²⁾	377,0	378,0 ⁽¹⁾	320,0*	342,0 ⁽¹⁾	300,0*	301,0 ⁽¹⁾	278,0*	278,0*		
24	B	388,0	397,0 ⁽²⁾	372,0	373,0 ⁽¹⁾	350,0	354,0 ⁽¹⁾	328,0	329,0 ⁽¹⁾	282,0*	301,0 ⁽¹⁾	262,0*	271,0 ⁽¹⁾	245,0*	245,0*
	BW	389,0	432,0 ⁽²⁾	369,0	372,0 ⁽²⁾	364,0	374,0 ⁽¹⁾	340,0	343,0 ⁽¹⁾	290,0*	269,0 ⁽¹⁾	269,0*	269,0*	251,0*	251,0*
26	B	361,0	379,0 ⁽²⁾	351,0	358,0 ⁽²⁾	334,0	343,0 ⁽¹⁾	314,0	320,0 ⁽¹⁾	295,0	296,0 ⁽¹⁾	273,0	273,0	236,0*	236,0*
	BW	364,0	425,0 ⁽²⁾	348,0	387,0 ⁽²⁾	350,0	371,0 ⁽¹⁾	329,0	341,0 ⁽¹⁾	307,0	307,0	260,0*	260,0*	243,0*	243,0*
28	B	291,0	362,0 ⁽²⁾	328,0	344,0 ⁽¹⁾	319,0	332,0 ⁽¹⁾	301,0	311,0 ⁽¹⁾	284,0	286,0 ⁽¹⁾	264,0	264,0	228,0*	228,0*
	BW	290,0	418,0 ⁽²⁾	327,0	383,0 ⁽²⁾	333,0	368,0 ⁽¹⁾	315,0	340,0 ⁽¹⁾	296,0	296,0	275,0	275,0	235,0*	235,0*
30	B		340,0 ⁽²⁾	306,0	329,0 ⁽²⁾	304,0	321,0 ⁽¹⁾	288,0	302,0 ⁽¹⁾	273,0	277,0 ⁽¹⁾	254,0	255,0 ⁽¹⁾	240,0	240,0
	BW		404,0 ⁽²⁾	309,0	379,0 ⁽²⁾	315,0	365,0 ⁽¹⁾	300,0	338,0 ⁽¹⁾	284,0	293,0 ⁽²⁾	266,0	266,0	249,0	249,0
32	B		319,0 ⁽⁴⁾	282,0	313,0 ⁽²⁾	288,0	309,0 ⁽¹⁾	276,0	293,0 ⁽¹⁾	262,0	268,0 ⁽²⁾	245,0	247,0 ⁽²⁾	232,0	232,0
	BW		388,0 ⁽²⁾	281,0	372,0 ⁽²⁾	298,0	360,0 ⁽¹⁾	284,0	337,0 ⁽¹⁾	271,0	292,0 ⁽²⁾	256,0	262,0 ⁽²⁾	241,0	241,0
34	B		300,0 ⁽⁶⁾	233,0	295,0 ⁽³⁾	272,0	291,0 ⁽²⁾	263,0	284,0 ⁽¹⁾	251,0	261,0 ⁽²⁾	236,0	242,0 ⁽²⁾	224,0	225,0 ⁽²⁾
	BW		372,0 ⁽⁶⁾	233,0	358,0 ⁽⁴⁾	284,0	348,0 ⁽¹⁾	270,0	335,0 ⁽¹⁾	259,0	292,0 ⁽²⁾	245,0	262,0 ⁽²⁾	232,0	237,0 ⁽²⁾
36	B		283,0 ⁽¹⁰⁾		278,0 ⁽⁴⁾	254,0	274,0 ⁽²⁾	250,0	268,0 ⁽¹⁾	240,0	253,0 ⁽²⁾	227,0	236,0 ⁽²⁾	216,0	221,0 ⁽²⁾
	BW		356,0 ⁽²⁾		345,0 ⁽⁴⁾	271,0	335,0 ⁽¹⁾	257,0	324,0 ⁽¹⁾	247,0	291,0 ⁽²⁾	234,0	261,0 ⁽²⁾	223,0	237,0 ⁽²⁾
38	B		266,0 ⁽¹⁰⁾		263,0 ⁽⁶⁾	242,0	259,0 ⁽⁴⁾	236,0	254,0 ⁽²⁾	230,0	246,0 ⁽²⁾	218,0	230,0 ⁽²⁾	207,0	216,0 ⁽²⁾
	BW		340,0 ⁽⁶⁾		330,0 ⁽²⁾	257,0	323,0 ⁽³⁾	245,0	312,0 ⁽²⁾	236,0	291,0 ⁽²⁾	223,0	261,0 ⁽²⁾	214,0	237,0 ⁽²⁾
40	B		250,0 ⁽¹⁰⁾		250,0 ⁽⁸⁾	214,0	246,0 ⁽⁵⁾	222,0	241,0 ⁽³⁾	219,0	237,0 ⁽²⁾	210,0	224,0 ⁽²⁾	200,0	211,0 ⁽²⁾
	BW		323,0 ⁽⁶⁾		317,0 ⁽²⁾	214,0	312,0 ⁽⁵⁾	235,0	302,0 ⁽³⁾	225,0	288,0 ⁽²⁾	214,0	261,0 ⁽²⁾	205,0	237,0 ⁽²⁾
44	B				224,0 ⁽¹⁰⁾		222,0 ⁽⁷⁾	203,0	218,0 ⁽⁵⁾	198,0	214,0 ⁽³⁾	192,0	207,0 ⁽²⁾	185,0	202,0 ⁽²⁾
	BW				289,0 ⁽²⁾		293,0 ⁽⁷⁾	212,0	281,0 ⁽⁴⁾	205,0	269,0 ⁽³⁾	196,0	254,0 ⁽²⁾	188,0	237,0 ⁽²⁾
48	B				197,0 ⁽¹⁰⁾		202,0 ⁽¹¹⁾		198,0 ⁽⁷⁾	180,0	196,0 ⁽⁵⁾	173,0	189,0 ⁽⁴⁾	170,0	185,0 ⁽³⁾
	BW				263,0 ⁽⁶⁾		266,0 ⁽⁸⁾		258,0 ⁽⁵⁾	190,0	250,0 ⁽³⁾	180,0	239,0 ⁽²⁾	174,0	228,0 ⁽²⁾
52	B				175,0 ⁽¹⁰⁾		180,0 ⁽¹¹⁾		181,0 ⁽⁹⁾	159,0	178,0 ⁽⁶⁾	158,0	174,0 ⁽⁵⁾	157,0	171,0 ⁽⁴⁾
	BW				241,0 ⁽⁸⁾		240,0 ⁽⁸⁾		238,0 ⁽⁸⁾	160,0	231,0 ⁽⁴⁾	166,0	224,0 ⁽²⁾	160,0	216,0 ⁽²⁾
56	B				157,0 ⁽¹⁰⁾		157,0 ⁽¹⁰⁾		164,0 ⁽¹¹⁾		164,0 ⁽⁸⁾	147,0	160,0 ⁽²⁾	142,0	158,0 ⁽⁵⁾
	BW				219,0 ⁽⁸⁾		218,0 ⁽¹⁰⁾		218,0 ⁽⁹⁾		214,0 ⁽⁶⁾	151,0	208,0 ⁽²⁾	149,0	205,0 ⁽²⁾
60	B				139,0 ⁽¹⁰⁾		141,0 ⁽¹⁰⁾		145,0 ⁽¹¹⁾		152,0 ⁽¹¹⁾		148,0 ⁽⁸⁾	131,0	146,0 ⁽⁶⁾
	BW				197,0 ⁽⁹⁾		199,0 ⁽¹⁰⁾		199,0 ⁽⁹⁾		197,0 ⁽⁸⁾		192,0 ⁽⁴⁾	137,0	190,0 ⁽³⁾
64	B				121,0 ⁽¹⁰⁾		125,0 ⁽¹⁰⁾		128,0 ⁽¹⁰⁾		135,0 ⁽¹¹⁾		137,0 ⁽¹⁰⁾	112,0	135,0 ⁽⁷⁾
	BW				175,0 ⁽¹⁰⁾		181,0 ⁽¹⁰⁾		183,0 ⁽¹⁰⁾		182,0 ⁽⁸⁾		178,0 ⁽⁶⁾	113,0	177,0 ⁽⁴⁾
68	B						110,0 ⁽¹⁰⁾		115,0 ⁽¹⁰⁾		119,0 ⁽¹⁰⁾		124,0 ⁽¹¹⁾		125,0 ⁽⁹⁾
	BW						162,0 ⁽¹⁰⁾		167,0 ⁽¹⁰⁾		169,0 ⁽¹⁰⁾		165,0 ⁽⁷⁾		164,0 ⁽⁵⁾
72	B						94,2 ⁽⁸⁾		101,0 ⁽¹⁰⁾		107,0 ⁽¹⁰⁾		110,0 ⁽¹¹⁾		116,0 ⁽¹¹⁾
	BW						144,0 ⁽⁸⁾		151,0 ⁽¹⁰⁾		155,0 ⁽¹⁰⁾		153,0 ⁽⁹⁾		152,0 ⁽⁶⁾
76	B						83,7 ⁽⁸⁾		87,6 ⁽¹⁰⁾		94,6 ⁽¹⁰⁾		96,8 ⁽¹⁰⁾		104,0 ⁽¹¹⁾
	BW						131,0 ⁽⁸⁾		134,0 ⁽¹⁰⁾		142,0 ⁽¹¹⁾		142,0 ⁽¹⁰⁾		143,0 ⁽⁸⁾
80	B						73,1 ⁽⁸⁾		76,2 ⁽⁸⁾		82,7 ⁽¹⁰⁾		86,1 ⁽¹⁰⁾		91,7 ⁽¹¹⁾
	BW						118,0 ⁽⁸⁾		121,0 ⁽⁸⁾		130,0 ⁽¹¹⁾		130,0 ⁽¹⁰⁾		132,0 ⁽⁹⁾
84	B						62,5 ⁽⁸⁾		66,8 ⁽⁸⁾		70,4 ⁽⁸⁾		75,4 ⁽¹⁰⁾		81,9 ⁽¹¹⁾
	BW						105,0 ⁽⁸⁾		110,0 ⁽⁸⁾		118,0 ⁽¹¹⁾		117,0 ⁽¹⁰⁾		121,0 ⁽⁹⁾
88	B								57,5 ⁽⁸⁾		61,9 ⁽⁸⁾		64,8 ⁽¹⁰⁾		72,2 ⁽¹¹⁾
	BW								98,2 ⁽⁸⁾		106,0 ⁽¹¹⁾		105,0 ⁽¹⁰⁾		110,0 ⁽⁹⁾
92	B										53,5 ⁽⁸⁾		54,7 ⁽⁸⁾		62,4 ⁽¹¹⁾
	BW										94,6 ⁽¹¹⁾		93,6 ⁽⁸⁾		99,5 ⁽¹⁰⁾
96	B										43,4 ⁽⁶⁾		46,9 ⁽⁸⁾		51,8 ⁽⁹⁾
	BW										82,8 ⁽¹¹⁾		84,0 ⁽⁸⁾		89,3 ⁽⁹⁾
100	B										37,0 ⁽⁶⁾		39,1 ⁽⁸⁾		44,4 ⁽⁹⁾
	BW										72,7 ⁽⁶⁾		74,4 ⁽⁸⁾		80,6 ⁽⁹⁾
104	B										30,5 ⁽⁶⁾				37,1 ⁽⁹⁾
	BW										65,3 ⁽⁶⁾				71,8 ⁽⁹⁾
108	B										24,1 ⁽⁶⁾				29,7 ⁽⁹⁾
	BW										57,8 ⁽⁶⁾				63,0 ⁽⁹⁾
112	B														22,5 ⁽⁷⁾
	BW														54,3 ⁽⁷⁾
116	B														16,8 ⁽⁷⁾
	BW														47,9 ⁽⁷⁾
120	B														11,2 ⁽⁷⁾
	BW														41,5 ⁽⁷⁾

1) 12° 2) 17° 3) 22° 4) 27° 5) 32° 6) 37° 7) 42° 8) 47° 9) 52° 10) 57° 11) 62°

PDW3B/PDW3BW

P 90

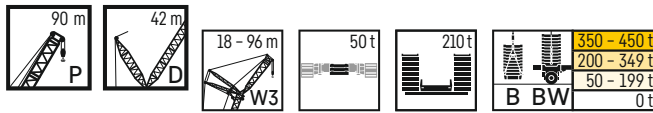

m	P 90 m													
	W3 60		W3 66		W3 72		W3 78		W3 84		W3 90		W3 96	
	87°/85	WVmax	87°/85	WVmax	87°/85	WVmax	87°/85	WVmax	87°/85	WVmax	87°/85	WVmax	87°/85	WVmax
26	B	219,0*	219,0*	176,0*	176,0*									
	BW	224,0*	224,0*											
28	B	212,0*	212,0*	197,0*	197,0*	157,0*	157,0*							
	BW	219,0*	219,0*	202,0*	202,0*									
30	B	205,0*	205,0*	191,0*	191,0*	176,0*	176,0*	162,0*	162,0*					
	BW	212,0*	212,0*	197,0*	197,0*	180,0*	180,0*	165,0*	165,0*					
32	B	216,0	216,0	184,0*	184,0*	171,0*	171,0*	157,0*	157,0*	143,0*	143,0*			
	BW	224,0	224,0	191,0*	191,0*	175,0*	175,0*	162,0*	162,0*	147,0*	147,0*			
34	B	209,0	209,0	194,0	194,0	179,0	179,0	153,0*	153,0*	140,0*	140,0*	130,0*	130,0*	
	BW	217,0	217,0	202,0	202,0	170,0*	170,0*	158,0*	158,0*	144,0*	144,0*	133,0*	133,0*	
36	B	202,0	203,0 ⁽²⁾	189,0	189,0	175,0	175,0	160,0	160,0	136,0*	136,0*	127,0*	127,0*	115,0*
	BW	210,0	214,0 ⁽²⁾	196,0	196,0	181,0	181,0	166,0	166,0	140,0*	140,0*	130,0*	130,0*	117,0*
38	B	195,0	199,0 ⁽²⁾	183,0	183,0	170,0	170,0	156,0	156,0	142,0	142,0	123,0*	123,0*	112,0*
	BW	203,0	214,0 ⁽²⁾	190,0	193,0 ⁽²⁾	176,0	176,0	164,0	164,0	148,0	148,0	127,0*	127,0*	115,0*
40	B	188,0	196,0 ⁽²⁾	177,0	179,0 ⁽²⁾	165,0	165,0	152,0	152,0	139,0	139,0	130,0	130,0	109,0*
	BW	195,0	214,0 ⁽²⁾	184,0	193,0 ⁽²⁾	172,0	172,0	160,0	160,0	146,0	146,0	133,0	133,0	112,0*
44	B	175,0	189,0 ⁽²⁾	165,0	175,0 ⁽²⁾	155,0	161,0 ⁽²⁾	144,0	146,0 ⁽²⁾	132,0	132,0	123,0	123,0	112,0
	BW	180,0	214,0 ⁽²⁾	171,0	193,0 ⁽²⁾	160,0	173,0 ⁽²⁾	151,0	156,0 ⁽²⁾	140,0	140,0	129,0	129,0	117,0
48	B	162,0	181,0 ⁽²⁾	153,0	170,0 ⁽²⁾	146,0	157,0 ⁽²⁾	136,0	144,0 ⁽²⁾	125,0	130,0 ⁽²⁾	117,0	118,0 ⁽²⁾	107,0
	BW	166,0	213,0 ⁽²⁾	158,0	193,0 ⁽²⁾	149,0	173,0 ⁽²⁾	141,0	156,0 ⁽²⁾	132,0	139,0 ⁽²⁾	124,0	126,0 ⁽²⁾	112,0
52	B	151,0	166,0 ⁽³⁾	142,0	160,0 ⁽³⁾	134,0	154,0 ⁽³⁾	127,0	142,0 ⁽³⁾	117,0	128,0 ⁽³⁾	110,0	117,0 ⁽²⁾	101,0
	BW	153,0	204,0 ⁽³⁾	146,0	190,0 ⁽³⁾	138,0	173,0 ⁽³⁾	131,0	156,0 ⁽³⁾	123,0	138,0 ⁽³⁾	117,0	125,0 ⁽²⁾	107,0
56	B	139,0	153,0 ⁽⁴⁾	133,0	148,0 ⁽³⁾	125,0	142,0 ⁽²⁾	118,0	139,0 ⁽²⁾	110,0	127,0 ⁽²⁾	104,0	117,0 ⁽²⁾	95,1
	BW	142,0	195,0 ⁽²⁾	135,0	184,0 ⁽²⁾	128,0	170,0 ⁽²⁾	122,0	156,0 ⁽²⁾	115,0	138,0 ⁽²⁾	109,0	125,0 ⁽²⁾	101,0
60	B	126,0	142,0 ⁽³⁾	123,0	137,0 ⁽⁴⁾	117,0	132,0 ⁽³⁾	109,0	125,0 ⁽³⁾	103,0	122,0 ⁽²⁾	97,7	116,0 ⁽²⁾	88,9
	BW	132,0	187,0 ⁽²⁾	125,0	178,0 ⁽²⁾	119,0	165,0 ⁽²⁾	113,0	153,0 ⁽²⁾	107,0	137,0 ⁽²⁾	102,0	125,0 ⁽²⁾	94,7
64	B	117,0	132,0 ⁽⁴⁾	112,0	127,0 ⁽³⁾	109,0	123,0 ⁽⁴⁾	102,0	117,0 ⁽³⁾	94,7	112,0 ⁽³⁾	91,3	108,0 ⁽²⁾	83,1
	BW	122,0	173,0 ⁽³⁾	117,0	170,0 ⁽²⁾	110,0	161,0 ⁽²⁾	106,0	150,0 ⁽²⁾	99,0	135,0 ⁽²⁾	94,7	123,0 ⁽²⁾	88,1
68	B	105,0	122,0 ⁽⁷⁾	102,0	118,0 ⁽⁴⁾	99,4	114,0 ⁽³⁾	95,4	109,0 ⁽⁴⁾	87,7	102,0 ⁽³⁾	84,2	101,0 ⁽³⁾	77,8
	BW	106,0	161,0 ⁽⁴⁾	108,0	158,0 ⁽³⁾	103,0	153,0 ⁽²⁾	98,2	147,0 ⁽²⁾	91,6	132,0 ⁽²⁾	87,7	121,0 ⁽²⁾	81,9
72	B		113,0 ⁽⁸⁾	93,9	111,0 ⁽⁷⁾	90,2	106,0 ⁽⁴⁾	85,7	102,0 ⁽⁵⁾	81,6	96,0 ⁽⁴⁾	77,6	90,8 ⁽³⁾	72,6
	BW		150,0 ⁽³⁾	96,8	147,0 ⁽⁴⁾	95,6	143,0 ⁽³⁾	91,6	140,0 ⁽²⁾	85,3	130,0 ⁽²⁾	81,6	119,0 ⁽²⁾	76,2
76	B		105,0 ⁽¹⁰⁾	77,3	101,0 ⁽⁸⁾	83,7	98,7 ⁽⁷⁾	79,4	94,1 ⁽⁴⁾	75,3	89,6 ⁽³⁾	72,1	85,7 ⁽⁴⁾	66,8
	BW		140,0 ⁽⁴⁾	77,3	137,0 ⁽³⁾	87,2	133,0 ⁽⁴⁾	85,2	131,0 ⁽³⁾	80,2	123,0 ⁽³⁾	75,7	117,0 ⁽²⁾	71,2
80	B		94,9 ⁽¹¹⁾		94,0 ⁽¹⁰⁾	74,7	90,7 ⁽⁸⁾	74,0	87,2 ⁽⁷⁾	69,0	82,2 ⁽⁴⁾	66,1	80,2 ⁽³⁾	61,4
	BW		130,0 ⁽⁷⁾		127,0 ⁽³⁾	73,7	123,0 ⁽⁴⁾	79,6	122,0 ⁽⁴⁾	74,7	119,0 ⁽³⁾	69,8	113,0 ⁽³⁾	65,6
84	B		84,8 ⁽¹¹⁾		85,7 ⁽¹¹⁾		84,0 ⁽⁹⁾	67,9	80,9 ⁽⁷⁾	64,2	76,0 ⁽⁴⁾	61,1	73,1 ⁽⁴⁾	56,5
	BW		120,0 ⁽⁸⁾		117,0 ⁽⁴⁾		113,0 ⁽⁴⁾	69,1	113,0 ⁽⁴⁾	69,0	110,0 ⁽³⁾	65,3	108,0 ⁽³⁾	60,2
88	B		75,4 ⁽¹¹⁾		77,6 ⁽¹¹⁾		77,8 ⁽¹¹⁾	54,1	74,5 ⁽⁹⁾	58,6	71,4 ⁽⁷⁾	56,2	68,2 ⁽⁴⁾	52,0
	BW		110,0 ⁽⁸⁾		108,0 ⁽⁴⁾		104,0 ⁽⁵⁾	54,4	104,0 ⁽⁴⁾	61,8	101,0 ⁽³⁾	60,6	99,7 ⁽³⁾	56,3
92	B		66,3 ⁽¹¹⁾		69,4 ⁽¹¹⁾		70,4 ⁽¹¹⁾		69,4 ⁽¹⁰⁾	51,0	64,7 ⁽⁸⁾	50,2	64,2 ⁽⁷⁾	46,7
	BW		101,0 ⁽⁸⁾		98,8 ⁽⁹⁾		95,7 ⁽⁵⁾		95,3 ⁽⁴⁾	51,9	92,2 ⁽⁴⁾	55,3	91,4 ⁽³⁾	51,6
96	B		57,3 ⁽¹¹⁾		61,0 ⁽¹¹⁾		63,0 ⁽¹¹⁾		62,6 ⁽¹¹⁾		59,6 ⁽¹⁰⁾	44,3	57,9 ⁽⁸⁾	41,0
	BW		91,5 ⁽⁹⁾		91,1 ⁽⁸⁾		87,8 ⁽⁷⁾		87,0 ⁽⁵⁾		84,4 ⁽⁴⁾	48,8	83,2 ⁽³⁾	45,6
100	B		48,2 ⁽¹¹⁾		52,5 ⁽¹¹⁾		55,3 ⁽¹¹⁾		56,4 ⁽¹¹⁾		55,4 ⁽¹¹⁾	35,9	53,1 ⁽⁹⁾	36,3
	BW		83,1 ⁽¹⁰⁾		83,3 ⁽⁹⁾		81,0 ⁽⁸⁾		79,5 ⁽⁵⁾		76,7 ⁽⁵⁾	36,0	75,8 ⁽⁴⁾	40,8
104	B		39,1 ⁽⁹⁾		44,1 ⁽¹¹⁾		47,4 ⁽¹¹⁾		49,8 ⁽¹¹⁾		49,4 ⁽¹¹⁾		49,0 ⁽¹⁰⁾	31,9
	BW		74,7 ⁽⁹⁾		76,4 ⁽⁹⁾		74,6 ⁽⁸⁾		72,9 ⁽⁶⁾		70,2 ⁽⁵⁾		68,9 ⁽⁴⁾	33,9
108	B		32,3 ⁽⁹⁾		34,4 ⁽⁹⁾		39,6 ⁽¹¹⁾		42,6 ⁽¹¹⁾		43,4 ⁽¹¹⁾		44,1 ⁽¹¹⁾	41,6 ⁽¹⁰⁾
	BW		66,8 ⁽⁹⁾		69,0 ⁽⁹⁾		68,3 ⁽⁹⁾		67,4 ⁽⁸⁾		64,1 ⁽⁴⁾		62,9 ⁽⁵⁾	60,0 ⁽⁴⁾
112	B		25,4 ⁽⁹⁾		28,0 ⁽⁹⁾		31,8 ⁽¹¹⁾		35,4 ⁽¹¹⁾		36,8 ⁽¹¹⁾		38,5 ⁽¹¹⁾	37,2 ⁽¹¹⁾
	BW		58,8 ⁽⁹⁾		61,2 ⁽⁹⁾		63,0 ⁽¹¹⁾		62,6 ⁽⁹⁾		59,3 ⁽⁷⁾		57,8 ⁽⁴⁾	54,5 ⁽⁵⁾
116	B				21,7 ⁽⁹⁾		23,5 ⁽⁹⁾		28,1 ⁽¹¹⁾		30,1 ⁽¹¹⁾		32,7 ⁽¹¹⁾	32,2 ⁽¹¹⁾
	BW		50,2 ⁽⁷⁾		53,3 ⁽⁹⁾		55,5 ⁽⁹⁾		57,9 ⁽⁹⁾		54,8 ⁽⁸⁾		52,9 ⁽⁴⁾	49,6 ⁽⁵⁾
120	B				15,4 ⁽⁹⁾		17,6 ⁽⁹⁾				23,3 ⁽¹¹⁾		26,3 ⁽¹¹⁾	10,7 ⁽⁵⁾
	BW		44,2 ⁽⁷⁾		45,5 ⁽⁹⁾		48,2 ⁽⁹⁾		52,0 ⁽⁹⁾		50,7 ⁽⁹⁾		48,6 ⁽⁸⁾	45,3 ⁽⁴⁾
124	B						11,6 ⁽⁹⁾				16,6 ⁽¹¹⁾		19,9 ⁽¹¹⁾	
	BW		38,3 ⁽⁷⁾		38,3 ⁽⁷⁾		40,8 ⁽⁹⁾		45,3 ⁽⁹⁾		46,8 ⁽¹¹⁾		45,0 ⁽⁹⁾	41,5 ⁽⁷⁾
128	B												13,6 ⁽¹¹⁾	
	BW				33,5 ⁽⁷⁾		32,7 ⁽⁷⁾		38,5 ⁽⁹⁾		40,1 ⁽⁹⁾		41,7 ⁽⁹⁾	38,2 ⁽⁸⁾
132	B													
	BW				28,7 ⁽⁷⁾		27,8 ⁽⁷⁾		31,8 ⁽⁹⁾		33,6 ⁽⁹⁾		36,6 ⁽⁹⁾	35,2 ⁽⁹⁾
136	B													
	BW						22,9 ⁽⁷⁾		25,3 ⁽⁷⁾		27,0 ⁽⁹⁾		30,6 ⁽⁹⁾	32,1 ⁽¹¹⁾
140	B													
	BW								20,5 ⁽⁷⁾		19,7 ⁽⁷⁾		24,5 ⁽⁹⁾	26,3 ⁽⁹⁾
144	B													
	BW								15,8 ⁽⁷⁾		15,7 ⁽⁷⁾		18,5 ⁽⁹⁾	20,7 ⁽⁹⁾
148	B													
	BW										11,8 ⁽⁷⁾		8,3 ⁽³⁾	15,0 ⁽⁹⁾

1) 12° 2) 17° 3) 22° 4) 27° 5) 32° 6) 37° 7) 42° 8) 47° 9) 52° 10) 57° 11) 62°

PDW3B/PDW3BW

P 96

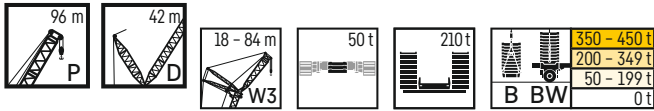

		P 96 m																										
		W3 18 m		W3 24 m		W3 30 m		W3 36 m		W3 42 m		W3 48 m		W3 54 m		W3 60 m		W3 66 m		W3 72 m		W3 78 m		W3 84 m				
		87°/85	WVmax	87°/85	WVmax	87°/85	WVmax	87°/85	WVmax	87°/85	WVmax	87°/85	WVmax	87°/85	WVmax	87°/85	WVmax	87°/85	WVmax	87°/85	WVmax	87°/85	WVmax	87°/85	WVmax	87°/85	WVmax	
16	B	401.0*	401.0*																									
	BW	409.0*	409.0*																									
18	B	383.0*	403.0 ⁽²⁾	357.0*	357.0*	333.0*	333.0*																					
	BW	388.0*	411.0 ⁽²⁾	362.0*	362.0*	339.0*	339.0*																					
20	B	403.0	403.0	341.0*	358.0 ⁽²⁾	322.0*	337.0 ⁽¹⁾	299.0*	299.0*	278.0*	278.0*																	
	BW	410.0	411.0 ⁽²⁾	343.0*	363.0 ⁽²⁾	328.0*	345.0 ⁽¹⁾	305.0*	305.0*	260.0*	260.0*																	
22	B	386.0	388.0 ⁽²⁾	360.0	360.0	337.0	337.0	289.0*	303.0 ⁽³⁾	270.0*	274.0 ⁽¹⁾	248.0*	248.0*															
	BW	387.0	406.0 ⁽²⁾	364.0	364.0	346.0	347.0 ⁽¹⁾	295.0*	312.0 ⁽³⁾	275.0*	275.0*																	
24	B	368.0	375.0 ⁽²⁾	345.0	348.0 ⁽²⁾	324.0	328.0 ⁽¹⁾	302.0	302.0	259.0*	273.0 ⁽¹⁾	241.0*	241.0*	224.0*	224.0*													
	BW	364.0	403.0 ⁽²⁾	344.0	361.0 ⁽²⁾	337.0	345.0 ⁽¹⁾	312.0	313.0 ⁽¹⁾	267.0*	267.0*	247.0*	247.0*	229.0*	229.0*													
26	B	351.0	362.0 ⁽²⁾	329.0	338.0 ⁽²⁾	310.0	320.0 ⁽¹⁾	290.0	296.0 ⁽¹⁾	270.0	271.0 ⁽¹⁾	232.0*	235.0 ⁽³⁾	217.0*	217.0*	200.0*	200.0*	163.0*	163.0*									
	BW	343.0	400.0 ⁽²⁾	325.0	360.0 ⁽²⁾	324.0	344.0 ⁽¹⁾	303.0	311.0 ⁽¹⁾	281.0	281.0	239.0*	239.0*	222.0*	222.0*	205.0*	205.0*											
28	B	313.0	349.0 ⁽²⁾	312.0	327.0 ⁽²⁾	296.0	313.0 ⁽¹⁾	279.0	290.0 ⁽¹⁾	261.0	264.0 ⁽¹⁾	243.0	243.0	209.0*	209.0*	194.0*	194.0*	179.0*	179.0*	144.0*	144.0*							
	BW	312.0	396.0 ⁽²⁾	306.0	359.0 ⁽²⁾	309.0	342.0 ⁽¹⁾	290.0	310.0 ⁽¹⁾	271.0	271.0	252.0	252.0	215.0*	215.0*	199.0*	199.0*	183.0*	183.0*									
30	B	334.0 ⁽²⁾	295.0	317.0 ⁽²⁾	284.0	305.0 ⁽¹⁾	267.0	284.0 ⁽¹⁾	251.0	256.0 ⁽¹⁾	234.0	234.0	220.0	220.0	187.0*	187.0*	175.0*	175.0*	160.0*	160.0*	125.0*	125.0*						
	BW	390.0 ⁽²⁾	288.0	358.0 ⁽²⁾	293.0	341.0 ⁽¹⁾	277.0	309.0 ⁽¹⁾	261.0	267.0 ⁽¹⁾	244.0	244.0	227.0	227.0	193.0*	193.0*	178.0*	178.0*	164.0*	164.0*								
32	B	314.0 ⁽³⁾	279.0	306.0 ⁽²⁾	272.0	297.0 ⁽¹⁾	256.0	277.0 ⁽¹⁾	242.0	249.0 ⁽¹⁾	227.0	228.0 ⁽²⁾	213.0	213.0	197.0	197.0	170.0*	170.0*	155.0*	155.0*	143.0*	143.0*						
	BW	376.0 ⁽²⁾	274.0	357.0 ⁽²⁾	278.0	339.0 ⁽¹⁾	264.0	307.0 ⁽¹⁾	250.0	266.0 ⁽²⁾	235.0	239.0 ⁽²⁾	220.0	220.0	204.0	204.0	173.0*	173.0*	159.0*	159.0*	146.0*	146.0*	134.0*	134.0*				
34	B	295.0 ⁽³⁾	249.0	290.0 ⁽³⁾	261.0	283.0 ⁽¹⁾	246.0	271.0 ⁽¹⁾	232.0	243.0 ⁽¹⁾	218.0	224.0 ⁽¹⁾	206.0	206.0	191.0	191.0	178.0	178.0	151.0*	151.0*	139.0*	139.0*						
	BW	361.0 ⁽²⁾	247.0	346.0 ⁽²⁾	265.0	332.0 ⁽¹⁾	251.0	306.0 ⁽¹⁾	239.0	266.0 ⁽²⁾	226.0	239.0 ⁽²⁾	213.0	215.0 ⁽²⁾	198.0	198.0	183.0	183.0	155.0*	155.0*	142.0*	142.0*	131.0*	131.0*				
36	B	279.0 ⁽³⁾		274.0 ⁽⁴⁾	248.0	268.0 ⁽²⁾	236.0	261.0 ⁽¹⁾	223.0	238.0 ⁽²⁾	210.0	220.0 ⁽²⁾	199.0	203.0 ⁽²⁾	185.0	185.0	173.0	173.0	158.0	158.0	135.0*	135.0*						
	BW	347.0 ⁽²⁾		334.0 ⁽²⁾	253.0	321.0 ⁽²⁾	239.0	300.0 ⁽¹⁾	229.0	265.0 ⁽²⁾	216.0	238.0 ⁽²⁾	205.0	215.0 ⁽²⁾	192.0	194.0 ⁽²⁾	179.0	179.0	165.0	165.0	138.0*	138.0*	127.0*	127.0*				
38	B	263.0 ⁽⁴⁾		259.0 ⁽³⁾	236.0	255.0 ⁽¹⁾	226.0	248.0 ⁽²⁾	215.0	233.0 ⁽²⁾	202.0	216.0 ⁽²⁾	192.0	201.0 ⁽²⁾	179.0	182.0 ⁽²⁾	168.0	168.0	154.0	154.0	143.0	143.0						
	BW	332.0 ⁽²⁾		321.0 ⁽²⁾	242.0	311.0 ⁽³⁾	229.0	292.0 ⁽²⁾	218.0	264.0 ⁽²⁾	207.0	238.0 ⁽²⁾	197.0	215.0 ⁽²⁾	186.0	194.0 ⁽²⁾	174.0	174.0	161.0	161.0	147.0	147.0	124.0*	124.0*				
40	B	248.0 ⁽¹⁾⁽³⁾		246.0 ⁽⁷⁾	224.0	242.0 ⁽⁴⁾	215.0	235.0 ⁽³⁾	206.0	228.0 ⁽²⁾	195.0	212.0 ⁽²⁾	185.0	198.0 ⁽²⁾	173.0	180.0 ⁽²⁾	163.0	165.0 ⁽²⁾	150.0	150.0	138.0	138.0						
	BW	317.0 ⁽⁴⁾		309.0 ⁽²⁾	229.0	300.0 ⁽¹⁾	220.0	283.0 ⁽²⁾	208.0	264.0 ⁽²⁾	198.0	238.0 ⁽²⁾	189.0	215.0 ⁽²⁾	179.0	194.0 ⁽²⁾	168.0	174.0 ⁽²⁾	157.0	157.0	144.0	144.0	131.0	131.0				
44	B	216.0 ⁽¹⁾⁽⁴⁾		222.0 ⁽¹⁾⁽³⁾		218.0 ⁽⁴⁾	197.0	213.0 ⁽⁴⁾	192.0	208.0 ⁽²⁾	180.0	202.0 ⁽²⁾	172.0	193.0 ⁽²⁾	161.0	177.0 ⁽²⁾	153.0	163.0 ⁽²⁾	142.0	147.0 ⁽²⁾	131.0	132.0 ⁽²⁾						
	BW	286.0 ⁽³⁾		284.0 ⁽²⁾		278.0 ⁽¹⁾⁽¹⁾	201.0	266.0 ⁽²⁾	191.0	252.0 ⁽²⁾	182.0	235.0 ⁽²⁾	174.0	215.0 ⁽²⁾	165.0	193.0 ⁽²⁾	156.0	174.0 ⁽²⁾	147.0	157.0 ⁽²⁾	137.0	140.0 ⁽²⁾	126.0	126.0				
48	B			196.0 ⁽¹⁾⁽¹⁾		199.0 ⁽¹⁾⁽³⁾		195.0 ⁽⁶⁾	174.0	192.0 ⁽¹⁾	166.0	184.0 ⁽³⁾	159.0	180.0 ⁽²⁾	149.0	173.0 ⁽²⁾	142.0	161.0 ⁽²⁾	133.0	146.0 ⁽²⁾	123.0	131.0 ⁽²⁾						
	BW			259.0 ⁽³⁾		255.0 ⁽⁸⁾		249.0 ⁽²⁾	176.0	238.0 ⁽²⁾	168.0	225.0 ⁽²⁾	160.0	210.0 ⁽²⁾	153.0	193.0 ⁽²⁾	145.0	174.0 ⁽²⁾	137.0	157.0 ⁽²⁾	129.0	140.0 ⁽²⁾	120.0	125.0 ⁽²⁾				
52	B			172.0 ⁽¹⁾⁽³⁾		178.0 ⁽¹⁾⁽¹⁾		178.0 ⁽⁸⁾	160.0	178.0 ⁽¹⁾	153.0	168.0 ⁽⁴⁾	148.0	165.0 ⁽³⁾	139.0	158.0 ⁽³⁾	132.0	156.0 ⁽²⁾	124.0	145.0 ⁽²⁾	116.0	131.0 ⁽²⁾						
	BW			238.0 ⁽¹⁾⁽³⁾		235.0 ⁽¹⁾⁽³⁾		229.0 ⁽²⁾	162.0	225.0 ⁽²⁾	155.0	215.0 ⁽²⁾	149.0	203.0 ⁽²⁾	141.0	189.0 ⁽²⁾	134.0	173.0 ⁽²⁾	127.0	157.0 ⁽²⁾	120.0	140.0 ⁽²⁾	113.0	125.0 ⁽²⁾				
56	B			155.0 ⁽¹⁾⁽³⁾		157.0 ⁽¹⁾⁽¹⁾		163.0 ⁽¹⁾⁽¹⁾	143.0	157.0 ⁽³⁾	137.0	152.0 ⁽³⁾	129.0	145.0 ⁽⁴⁾	123.0	144.0 ⁽³⁾	115.0	137.0 ⁽²⁾	109.0	131.0 ⁽²⁾								
	BW			218.0 ⁽¹⁾⁽³⁾		215.0 ⁽³⁾		211.0 ⁽⁹⁾	160.0	208.0 ⁽¹⁾	143.0	204.0 ⁽²⁾	138.0	196.0 ⁽²⁾	131.0	184.0 ⁽²⁾	124.0	170.0 ⁽²⁾	118.0	155.0 ⁽²⁾	112.0	141.0 ⁽²⁾	105.0	126.0 ⁽²⁾				
60	B			138.0 ⁽¹⁾⁽³⁾		139.0 ⁽¹⁾⁽³⁾		145.0 ⁽¹⁾	150.0	150.0 ⁽¹⁾	144.0 ⁽⁷⁾	127.0	142.0 ⁽⁶⁾	121.0	135.0 ⁽³⁾	115.0	132.0 ⁽⁴⁾	107.0	127.0 ⁽³⁾	102.0	120.0 ⁽²⁾							
	BW			197.0 ⁽¹⁾⁽³⁾		197.0 ⁽¹⁾⁽³⁾		196.0 ⁽⁸⁾	192.0 ⁽⁵⁾	192.0 ⁽⁵⁾	189.0 ⁽³⁾	128.0	186.0 ⁽²⁾	122.0	179.0 ⁽²⁾	115.0	167.0 ⁽²⁾	110.0	154.0 ⁽²⁾	104.0	139.0 ⁽²⁾	98.4	125.0 ⁽²⁾					
64	B			121.0 ⁽¹⁾⁽³⁾		125.0 ⁽¹⁾⁽³⁾		127.0 ⁽¹⁾⁽³⁾	135.0 ⁽¹⁾	135.0 ⁽¹⁾	132.0 ⁽⁹⁾	118.0	133.0 ⁽⁷⁾	112.0	126.0 ⁽⁴⁾	107.0	122.0 ⁽³⁾	100.0	117.0 ⁽⁴⁾	93.7	113.0 ⁽³⁾							
	BW			177.0 ⁽¹⁾⁽³⁾		180.0 ⁽¹⁾⁽³⁾		181.0 ⁽¹⁾⁽³⁾	179.0 ⁽⁷⁾	179.0 ⁽⁷⁾	175.0 ⁽⁵⁾	116.0	172.0 ⁽³⁾	113.0	169.0 ⁽²⁾	108.0	164.0 ⁽²⁾	102.0	152.0 ⁽²⁾	96.7	137.0 ⁽²⁾	91.1	124.0 ⁽²⁾					
68	B			110.0 ⁽¹⁾⁽³⁾		114.0 ⁽¹⁾⁽³⁾		121.0 ⁽¹⁾	121.0 ⁽¹⁾	121.0 ⁽¹⁾	122.0 ⁽¹⁾⁽⁴⁾	102.0	120.0 ⁽⁹⁾	102.0	116.0 ⁽⁷⁾	98.8	114.0 ⁽⁶⁾	93.2	108.0 ⁽³⁾	87.3	105.0 ⁽⁴⁾							
	BW			162.0 ⁽¹⁾⁽³⁾		166.0 ⁽¹⁾⁽³⁾		166.0 ⁽¹⁾⁽³⁾	160.0 ⁽¹⁾	160.0 ⁽¹⁾	163.																	

PDW3B/PDW3BW

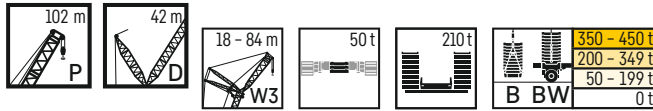

		P 102 m																										
		W3 18 m		W3 24 m		W3 30 m		W3 36 m		W3 42 m		W3 48 m		W3 54 m		W3 60 m		W3 66 m		W3 72 m		W3 78 m		W3 84 m				
		87°/85	WVmax	87°/85	WVmax	87°/85	WVmax	87°/85	WVmax	87°/85	WVmax	87°/85	WVmax	87°/85	WVmax	87°/85	WVmax	87°/85	WVmax	87°/85	WVmax	87°/85	WVmax	87°/85	WVmax	87°/85	WVmax	
16	B	368,0*	368,0*																									
	BW	375,0*	375,0*																									
18	B	353,0*	367,0 ⁽²⁾	328,0*	328,0*																							
	BW	358,0*	374,0 ⁽²⁾	334,0*	334,0*	310,0*	310,0*																					
20	B	370,0	370,0	315,0*	326,0 ⁽²⁾																							
	BW	378,0	378,0	316,0*	330,0 ⁽²⁾	301,0*	312,0 ⁽³⁾	278,0*	278,0*																			
22	B	356,0	358,0 ⁽²⁾	331,0	331,0																							
	BW	357,0	373,0 ⁽²⁾	332,0	332,0	315,0	315,0	270,0*	273,0 ⁽¹⁾	251,0*	251,0*	207,0*	207,0*															
24	B	340,0	349,0 ⁽²⁾	318,0	322,0 ⁽²⁾																							
	BW	338,0	372,0 ⁽²⁾	315,0	327,0 ⁽²⁾	309,0	313,0 ⁽³⁾	260,0*	269,0 ⁽²⁾	243,0*	243,0*	224,0*	224,0*	186,0*	186,0*													
26	B	325,0	341,0 ⁽²⁾	304,0	315,0 ⁽²⁾																							
	BW	319,0	371,0 ⁽²⁾	299,0	327,0 ⁽²⁾	298,0	311,0 ⁽³⁾	275,0	275,0	234,0*	241,0 ⁽²⁾	217,0*	217,0*	202,0*	202,0*	184,0*	184,0*											
28	B	310,0	332,0 ⁽²⁾	290,0	307,0 ⁽²⁾																							
	BW	303,0	369,0 ⁽²⁾	282,0	326,0 ⁽²⁾	284,0	310,0 ⁽³⁾	265,0	269,0 ⁽²⁾	245,0	245,0	226,0	226,0	195,0*	195,0*	178,0*	178,0*	165,0*	165,0*	132,0*	132,0*							
30	B	323,0 ⁽²⁾	276,0	300,0 ⁽²⁾																								
	BW	368,0 ⁽²⁾	266,0	326,0 ⁽²⁾	270,0	309,0 ⁽³⁾	254,0	268,0 ⁽²⁾	237,0	239,0 ⁽²⁾	219,0	219,0	203,0	203,0	173,0*	173,0*	160,0*	160,0*	146,0*	146,0*	118,0*	118,0*						
32	B	307,0 ⁽²⁾	262,0	293,0 ⁽²⁾																								
	BW	359,0 ⁽²⁾	256,0	326,0 ⁽²⁾	257,0	307,0 ⁽¹⁾	242,0	267,0 ⁽²⁾	229,0	239,0 ⁽²⁾	212,0	213,0 ⁽²⁾	197,0	197,0	181,0	181,0	155,0*	155,0*	142,0*	142,0*	131,0*	131,0*						
34	B	289,0 ⁽⁴⁾	249,0	283,0 ⁽²⁾																								
	BW	347,0 ⁽²⁾	241,0	321,0 ⁽²⁾	245,0	305,0 ⁽¹⁾	231,0	266,0 ⁽²⁾	220,0	239,0 ⁽²⁾	204,0	213,0 ⁽²⁾	192,0	192,0	177,0	177,0	164,0	164,0	138,0*	138,0*	127,0*	127,0*	115,0*	115,0*				
36	B	274,0 ⁽⁶⁾		268,0 ⁽³⁾																								
	BW	334,0 ⁽²⁾		312,0 ⁽²⁾	233,0	297,0 ⁽¹⁾	221,0	265,0 ⁽²⁾	210,0	239,0 ⁽²⁾	197,0	213,0 ⁽²⁾	185,0	192,0 ⁽²⁾	171,0	171,0	159,0	159,0	146,0	146,0	124,0*	124,0*	112,0*	112,0*				
38	B	259,0 ⁽⁹⁾		254,0 ⁽⁴⁾																								
	BW	322,0 ⁽²⁾		304,0 ⁽²⁾	225,0	290,0 ⁽¹⁾	211,0	265,0 ⁽²⁾	201,0	239,0 ⁽²⁾	189,0	213,0 ⁽²⁾	179,0	192,0 ⁽²⁾	166,0	171,0 ⁽²⁾	155,0	155,0	142,0	142,0	131,0	131,0	109,0*	109,0*				
40	B	245,0 ⁽¹¹⁾		241,0 ⁽⁶⁾																								
	BW	310,0 ⁽²⁾		295,0 ⁽²⁾	215,0	283,0 ⁽¹⁾	202,0	260,0 ⁽²⁾	193,0	239,0 ⁽²⁾	181,0	213,0 ⁽²⁾	173,0	192,0 ⁽²⁾	161,0	171,0 ⁽²⁾	151,0	154,0 ⁽²⁾	138,0	138,0	128,0	128,0	116,0	116,0				
44	B	215,0 ⁽¹¹⁾		219,0 ⁽¹⁰⁾																								
	BW	284,0 ⁽²⁾		277,0 ⁽²⁾	269,0 ⁽¹⁾	186,0	249,0 ⁽²⁾	176,0	233,0 ⁽²⁾	167,0	213,0 ⁽²⁾	160,0	191,0 ⁽²⁾	150,0	170,0 ⁽²⁾	142,0	154,0 ⁽²⁾	131,0	137,0 ⁽²⁾	122,0	124,0 ⁽²⁾	111,0	111,0					
48	B	187,0 ⁽⁹⁾		195,0 ⁽¹¹⁾																								
	BW	259,0 ⁽⁶⁾		254,0 ⁽³⁾	249,0 ⁽¹⁾		238,0 ⁽²⁾	164,0	225,0 ⁽²⁾	154,0	207,0 ⁽²⁾	148,0	190,0 ⁽²⁾	139,0	170,0 ⁽²⁾	132,0	153,0 ⁽²⁾	124,0	136,0 ⁽²⁾	115,0	123,0 ⁽²⁾	105,0	109,0 ⁽²⁾					
52	B	169,0 ⁽⁹⁾		171,0 ⁽¹¹⁾																								
	BW	236,0 ⁽⁹⁾		233,0 ⁽⁸⁾	228,0 ⁽⁴⁾		223,0 ⁽²⁾	151,0	217,0 ⁽²⁾	143,0	202,0 ⁽²⁾	136,0	187,0 ⁽²⁾	129,0	169,0 ⁽²⁾	123,0	153,0 ⁽²⁾	115,0	136,0 ⁽²⁾	109,0	123,0 ⁽²⁾	100,0	109,0 ⁽²⁾					
56	B	150,0 ⁽⁹⁾		153,0 ⁽¹⁰⁾																								
	BW	213,0 ⁽⁹⁾		214,0 ⁽¹⁰⁾	211,0 ⁽⁷⁾		206,0 ⁽⁴⁾		203,0 ⁽²⁾	132,0	197,0 ⁽²⁾	128,0	185,0 ⁽²⁾	120,0	168,0 ⁽²⁾	114,0	152,0 ⁽²⁾	107,0	136,0 ⁽²⁾	102,0	123,0 ⁽²⁾	94,5	109,0 ⁽²⁾					
60	B	131,0 ⁽⁹⁾		137,0 ⁽¹⁰⁾																								
	BW	190,0 ⁽⁹⁾		195,0 ⁽¹⁰⁾	194,0 ⁽⁸⁾		190,0 ⁽⁶⁾		188,0 ⁽⁴⁾		183,0 ⁽⁵⁾	118,0	181,0 ⁽²⁾	111,0	166,0 ⁽²⁾	106,0	151,0 ⁽²⁾	99,6	134,0 ⁽²⁾	94,6	122,0 ⁽²⁾	88,1	108,0 ⁽²⁾					
64	B			121,0 ⁽¹⁰⁾																								
	BW			176,0 ⁽¹⁰⁾	178,0 ⁽¹⁰⁾		177,0 ⁽⁹⁾		175,0 ⁽⁶⁾		170,0 ⁽⁴⁾	110,0	169,0 ⁽³⁾	104,0	162,0 ⁽²⁾	99,6	150,0 ⁽²⁾	92,1	133,0 ⁽²⁾	87,9	121,0 ⁽²⁾	82,0	107,0 ⁽²⁾					
68	B			105,0 ⁽¹⁰⁾																								
	BW			157,0 ⁽¹⁰⁾	161,0 ⁽¹⁰⁾		163,0 ⁽¹⁰⁾		163,0 ⁽⁸⁾		158,0 ⁽⁶⁾		157,0 ⁽⁴⁾	96,6	153,0 ⁽⁵⁾	92,5	144,0 ⁽²⁾	86,3	132,0 ⁽²⁾	81,9	119,0 ⁽²⁾	76,5	106,0 ⁽²⁾					
72	B																											
	BW				144,0 ⁽¹⁰⁾		148,0 ⁽¹⁰⁾		151,0 ⁽¹⁰⁾		148,0 ⁽⁷⁾		146,0 ⁽⁵⁾		142,0 ⁽⁴⁾	85,7	140,0 ⁽³⁾	80,5	129,0 ⁽⁵⁾	76,9	118,0 ⁽²⁾	70,7	104,0 ⁽²⁾					
76	B																											
	BW				126,0 ⁽⁸⁾		134,0 ⁽¹⁰⁾		139,0 ⁽¹⁰⁾		138,0 ⁽¹⁰⁾		137,0 ⁽⁷⁾		133,0 ⁽⁵⁾	80,4	131,0 ⁽⁴⁾	75,2	126,0 ⁽⁵⁾	71,9	116,0 ⁽³⁾	65,6	102,0 ⁽²⁾					
80	B																											
	BW				115,0 ⁽⁸⁾		119,0 ⁽¹⁰⁾		126,0 ⁽¹⁰⁾		127,0 ⁽¹⁰⁾		128,0 ⁽⁹⁾		124,0 ⁽⁶⁾		123,0 ⁽⁵⁾	69,4	119,0 ⁽⁴⁾	66,4	112,0 ⁽³⁾	61,4	102,0 ⁽³⁾					
84	B																											
	BW				103,0 ⁽⁸⁾		105,0 ⁽⁸⁾		113,0 ⁽¹⁰⁾		115,0 ⁽¹⁰⁾		120,0 ⁽¹¹⁾		117,0 ⁽⁸⁾		115,0 ⁽⁴⁾		111,0 ⁽⁵⁾	61,8	109,0 ⁽⁴⁾	57,3	98,0 ⁽⁴⁾					
88	B																											
	BW				91,3 ⁽⁸⁾		94,1 ⁽⁸⁾		98,4 ⁽⁸⁾		104,0 ⁽¹⁰⁾		109,0 ⁽¹¹⁾		109,0 ⁽¹⁰⁾		107,0 ⁽⁸⁾		104,0 ⁽⁶⁾	58,0	103,0 ⁽³⁾	53,4	97,2 ⁽⁴⁾					
92	B																											
	BW						83,2 ⁽⁸⁾		88,5 ⁽⁸⁾		92,6 ⁽¹⁰⁾		99,3 ⁽¹¹⁾		99,6 ⁽¹⁰⁾		101,0 ⁽⁹⁾		97,3 ⁽⁷⁾	96,7 ⁽⁶⁾	49,8	91,9 ⁽⁵⁾						
96	B																											
	BW						72,3 ⁽⁸⁾		78,7 ⁽⁸⁾		80,9 ⁽⁸⁾		89,0 ⁽¹¹⁾		90,5 ⁽¹⁰⁾		92,6 ⁽⁹⁾		91,0 ⁽⁸⁾	89,9 ⁽⁷⁾		85,2 ⁽⁵⁾						
100	B																											
	BW								68,8 ⁽⁸⁾		71,9 ⁽⁸⁾		77,6 ⁽⁹⁾		81,4 ⁽¹⁰⁾		84,2 ⁽⁹⁾		83,7 ⁽⁹⁾	82,9 ⁽⁸⁾		79,1 ⁽⁶⁾						
104	B																											
	BW								57,5 ⁽⁶⁾		62,9 ⁽⁸⁾		68,9 ⁽⁹⁾		72,3 ⁽¹⁰⁾		75,9 ⁽¹⁰⁾		76,2 ⁽⁹⁾	76,2 ⁽								

PDW3B/PDW3BW

P 108

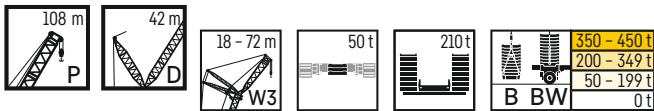

		P 108 m																			
m	B BW	W3 18 m		W3 24 m		W3 30 m		W3 36 m		W3 42 m		W3 48 m		W3 54 m		W3 60 m		W3 66 m		W3 72 m	
		87°/85	WVmax	87°/85	WVmax	87°/85	WVmax	87°/85	WVmax	87°/85	WVmax	87°/85	WVmax	87°/85	WVmax	87°/85	WVmax	87°/85	WVmax	87°/85	WVmax
16	B	336,0*	336,0*																		
	BW	341,0*	341,0*																		
18	B	323,0*	332,0 ⁽²⁾																		
	BW	328,0*	334,0 ⁽²⁾	302,0*	302,0*	279,0*	279,0*														
20	B	337,0	337,0																		
	BW	333,0	333,0	289,0*	294,0 ⁽²⁾	272,0*	278,0 ⁽¹⁾	250,0*	250,0*												
22	B	326,0	326,0																		
	BW	316,0	326,0 ⁽²⁾	293,0	293,0	264,0*	277,0 ⁽¹⁾	244,0*	244,0*	224,0*	224,0*										
24	B	312,0	320,0 ⁽³⁾																		
	BW	299,0	328,0 ⁽²⁾	278,0	285,0 ⁽²⁾	271,0	276,0 ⁽¹⁾	235,0*	239,0 ⁽²⁾	217,0*	217,0*	198,0*	198,0*	165,0*	165,0*						
26	B	298,0	313,0 ⁽²⁾																		
	BW	281,0	329,0 ⁽²⁾	263,0	287,0 ⁽²⁾	261,0	275,0 ⁽¹⁾	240,0	240,0	210,0*	213,0 ⁽²⁾	191,0*	191,0*	177,0*	177,0*	145,0*	145,0*				
28	B	285,0	306,0 ⁽²⁾																		
	BW	271,0	330,0 ⁽²⁾	248,0	289,0 ⁽²⁾	250,0	274,0 ⁽¹⁾	232,0	233,0 ⁽²⁾	215,0	215,0	185,0*	188,0 ⁽²⁾	172,0*	172,0*	156,0*	156,0*	143,0*	143,0*	116,0*	116,0*
30	B	268,0	300,0 ⁽²⁾																		
	BW	256,0	332,0 ⁽²⁾	235,0	291,0 ⁽²⁾	239,0	273,0 ⁽¹⁾	223,0	234,0 ⁽²⁾	207,0	207,0	190,0	190,0	166,0*	168,0 ⁽²⁾	152,0*	152,0*	139,0*	139,0*	127,0*	127,0*
32	B		292,0 ⁽²⁾																		
	BW		331,0 ⁽²⁾	229,0	293,0 ⁽²⁾	229,0	272,0 ⁽¹⁾	214,0	234,0 ⁽²⁾	200,0	208,0 ⁽²⁾	184,0	184,0	171,0	171,0	157,0	157,0	135,0*	135,0*	124,0*	124,0*
34	B		275,0 ⁽²⁾																		
	BW		323,0 ⁽²⁾	215,0	295,0 ⁽²⁾	220,0	272,0 ⁽¹⁾	205,0	234,0 ⁽²⁾	193,0	209,0 ⁽²⁾	178,0	185,0 ⁽²⁾	166,0	166,0	152,0	152,0	140,0	140,0	120,0*	120,0*
36	B		259,0 ⁽²⁾																		
	BW		315,0 ⁽²⁾	204,0	290,0 ⁽²⁾	210,0	268,0 ⁽¹⁾	197,0	235,0 ⁽²⁾	185,0	209,0 ⁽²⁾	172,0	185,0 ⁽²⁾	161,0	166,0 ⁽²⁾	148,0	148,0	136,0	136,0	125,0	125,0
38	B		244,0 ⁽⁴⁾																		
	BW		306,0 ⁽²⁾		284,0 ⁽²⁾	207,0	265,0 ⁽¹⁾	189,0	235,0 ⁽²⁾	178,0	210,0 ⁽²⁾	166,0	186,0 ⁽²⁾	156,0	166,0 ⁽²⁾	143,0	147,0 ⁽²⁾	132,0	132,0	122,0	122,0
40	B		230,0 ⁽⁵⁾																		
	BW		298,0 ⁽²⁾		279,0 ⁽²⁾	198,0	262,0 ⁽¹⁾	183,0	235,0 ⁽²⁾	172,0	211,0 ⁽²⁾	160,0	186,0 ⁽²⁾	151,0	167,0 ⁽²⁾	139,0	147,0 ⁽²⁾	128,0	130,0 ⁽²⁾	118,0	118,0
44	B		206,0 ⁽⁷⁾																		
	BW		275,0 ⁽⁵⁾		267,0 ⁽²⁾		255,0 ⁽¹⁾	172,0	230,0 ⁽²⁾	159,0	210,0 ⁽²⁾	149,0	188,0 ⁽²⁾	141,0	168,0 ⁽²⁾	130,0	148,0 ⁽²⁾	121,0	131,0 ⁽²⁾	111,0	117,0 ⁽²⁾
48	B		185,0 ⁽¹¹⁾																		
	BW		252,0 ⁽¹¹⁾		249,0 ⁽²⁾		241,0 ⁽²⁾	159,0	224,0 ⁽²⁾	151,0	206,0 ⁽²⁾	138,0	185,0 ⁽²⁾	131,0	169,0 ⁽²⁾	122,0	149,0 ⁽²⁾	113,0	132,0 ⁽²⁾	105,0	117,0 ⁽²⁾
52	B																				
	BW				229,0 ⁽⁶⁾		223,0 ⁽³⁾		219,0 ⁽²⁾	140,0	202,0 ⁽²⁾	132,0	182,0 ⁽²⁾	123,0	166,0 ⁽²⁾	114,0	148,0 ⁽²⁾	106,0	132,0 ⁽²⁾	99,0	118,0 ⁽²⁾
56	B																				
	BW				211,0 ⁽⁷⁾		206,0 ⁽⁶⁾		202,0 ⁽³⁾		196,0 ⁽²⁾	122,0	179,0 ⁽²⁾	117,0	163,0 ⁽²⁾	106,0	146,0 ⁽²⁾	99,7	131,0 ⁽²⁾	92,7	118,0 ⁽²⁾
60	B																				
	BW				192,0 ⁽⁷⁾		190,0 ⁽⁷⁾		187,0 ⁽⁵⁾		184,0 ⁽³⁾	114,0	172,0 ⁽²⁾	109,0	160,0 ⁽²⁾	102,0	144,0 ⁽²⁾	93,2	129,0 ⁽²⁾	86,8	116,0 ⁽²⁾
64	B																				
	BW				174,0 ⁽¹⁰⁾		173,0 ⁽⁷⁾		174,0 ⁽⁷⁾		172,0 ⁽⁵⁾		163,0 ⁽⁴⁾	102,0	154,0 ⁽³⁾	95,0	141,0 ⁽²⁾	89,3	127,0 ⁽²⁾	81,7	114,0 ⁽²⁾
68	B																				
	BW				157,0 ⁽¹⁰⁾		158,0 ⁽¹⁰⁾		159,0 ⁽⁷⁾		158,0 ⁽⁵⁾		154,0 ⁽⁵⁾		147,0 ⁽⁴⁾	88,4	136,0 ⁽⁵⁾	83,5	125,0 ⁽²⁾	78,5	112,0 ⁽²⁾
72	B																				
	BW				140,0 ⁽¹⁰⁾		143,0 ⁽¹⁰⁾		145,0 ⁽⁷⁾		145,0 ⁽⁶⁾		142,0 ⁽⁶⁾		139,0 ⁽⁵⁾	83,7	130,0 ⁽⁴⁾	78,1	122,0 ⁽⁵⁾	73,8	110,0 ⁽⁵⁾
76	B																				
	BW						127,0 ⁽¹⁰⁾		131,0 ⁽¹⁰⁾		132,0 ⁽⁷⁾		130,0 ⁽⁶⁾		130,0 ⁽⁶⁾		124,0 ⁽⁵⁾	73,4	116,0 ⁽⁴⁾	68,0	109,0 ⁽⁵⁾
80	B																				
	BW								118,0 ⁽¹⁰⁾		121,0 ⁽¹⁰⁾		119,0 ⁽⁷⁾		120,0 ⁽⁷⁾		118,0 ⁽⁶⁾		110,0 ⁽⁵⁾	63,7	103,0 ⁽⁴⁾
84	B																				
	BW								104,0 ⁽⁸⁾		110,0 ⁽¹⁰⁾		109,0 ⁽¹⁰⁾		111,0 ⁽⁷⁾		108,0 ⁽⁸⁾		105,0 ⁽⁶⁾	60,2	98,1 ⁽⁵⁾
88	B																				
	BW								88,7 ⁽⁵⁾		98,7 ⁽¹⁰⁾		99,6 ⁽¹⁰⁾		101,0 ⁽⁷⁾		98,9 ⁽⁶⁾		97,6 ⁽⁶⁾		93,1 ⁽⁶⁾
92	B																				
	BW								73,7 ⁽⁸⁾		83,5 ⁽⁸⁾		90,1 ⁽¹⁰⁾		92,5 ⁽¹¹⁾		91,8 ⁽¹¹⁾		89,5 ⁽⁷⁾		87,5 ⁽⁶⁾
96	B																				
	BW								58,7 ⁽⁸⁾		70,2 ⁽⁸⁾		80,4 ⁽⁹⁾		84,0 ⁽¹¹⁾		84,2 ⁽¹¹⁾		82,9 ⁽¹¹⁾		80,2 ⁽⁷⁾
100	B																				
	BW								43,6 ⁽⁸⁾		56,9 ⁽⁸⁾		67,9 ⁽⁹⁾		75,4 ⁽¹¹⁾		76,5 ⁽¹¹⁾		76,1 ⁽¹¹⁾		75,1 ⁽¹⁰⁾
104	B																				
	BW																				
108	B																				
	BW																				
112	B																				
	BW																				
116	B																				
	BW																				
120	B																				
	BW																				
124	B																				
	BW																				
128	B																				
	BW																				

1) 12° 2) 17° 3) 22° 4) 27° 5) 32° 6) 37° 7) 42° 8) 47° 9) 52° 10) 57° 11) 62°

PDW3B/PDW3BW

P 114 - 120

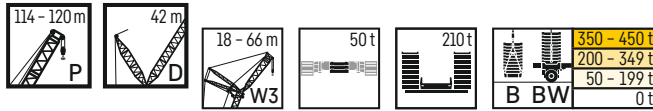

m	P 114 m										P 120 m												
	W3 18 m		W3 24 m		W3 30 m		W3 36 m		W3 42 m		W3 48 m		W3 54 m		W3 60 m		W3 66 m		W3 18 m		W3 24 m		
	87*/85	WVmax	87*/85	WVmax	87*/85	WVmax	87*/85	WVmax	87*/85	WVmax	87*/85	WVmax	87*/85	WVmax	87*/85	WVmax	87*/85	WVmax	87*/85	WVmax	87*/85	WVmax	
16	309,0*	309,0*																		272,0*	272,0*		
18	294,0*	298,0 ⁽²⁾	270,0*	270,0*	233,0*	233,0*														263,0*	265,0 ⁽¹⁾	241,0*	241,0*
20	279,0*	291,0 ⁽²⁾	258,0*	261,0 ⁽²⁾	247,0*	250,0 ⁽¹⁾	225,0*	225,0*												249,0*	259,0 ⁽¹⁾	230,0*	230,0*
22	281,0	284,0 ⁽²⁾	260,0	260,0	239,0*	246,0 ⁽¹⁾	218,0*	221,0 ⁽¹⁾	200,0*	200,0*										250,0	253,0 ⁽¹⁾	219,0*	225,0 ⁽²⁾
24	266,0	280,0 ⁽²⁾	248,0	249,0 ⁽²⁾	240,0	243,0 ⁽¹⁾	211,0*	217,0 ⁽¹⁾	194,0*	197,0 ⁽¹⁾	177,0*	177,0*	162,0*	162,0*						236,0	247,0 ⁽¹⁾	219,0	220,0 ⁽¹⁾
26	250,0	276,0 ⁽²⁾	233,0	245,0 ⁽²⁾	231,0	240,0 ⁽¹⁾	213,0	213,0	187,0*	193,0 ⁽¹⁾	171,0*	174,0 ⁽¹⁾	157,0*	158,0 ⁽¹⁾	143,0*	143,0*				223,0	240,0 ⁽¹⁾	207,0	215,0 ⁽¹⁾
28	236,0	272,0 ⁽²⁾	221,0	242,0 ⁽²⁾	221,0	237,0 ⁽¹⁾	205,0	209,0 ⁽¹⁾	190,0	190,0	165,0*	170,0 ⁽¹⁾	152,0*	154,0 ⁽¹⁾	138,0*	139,0 ⁽¹⁾	128,0*	128,0*	208,0	234,0 ⁽¹⁾	196,0	211,0 ⁽¹⁾	
30	226,0	267,0 ⁽²⁾	208,0	238,0 ⁽²⁾	212,0	233,0 ⁽¹⁾	197,0	205,0 ⁽¹⁾	183,0	186,0 ⁽¹⁾	169,0	169,0	148,0*	151,0 ⁽¹⁾	134,0*	135,0 ⁽¹⁾	124,0*	124,0*	202,0	228,0 ⁽¹⁾	184,0	206,0 ⁽¹⁾	
32		263,0 ⁽²⁾	200,0	234,0 ⁽²⁾	202,0	230,0 ⁽¹⁾	189,0	201,0 ⁽¹⁾	176,0	182,0 ⁽¹⁾	163,0	163,0	151,0	151,0	130,0*	130,0*	121,0*	121,0*		222,0 ⁽¹⁾	174,0	202,0 ⁽¹⁾	
34		263,0 ⁽²⁾	191,0	230,0 ⁽²⁾	194,0	227,0 ⁽¹⁾	181,0	197,0 ⁽¹⁾	170,0	178,0 ⁽¹⁾	158,0	160,0 ⁽²⁾	147,0	147,0	135,0	135,0	117,0*	117,0*		216,0 ⁽¹⁾	170,0	197,0 ⁽¹⁾	
36		265,0 ⁽²⁾	178,0	229,0 ⁽²⁾	186,0	224,0 ⁽¹⁾	174,0	194,0 ⁽²⁾	163,0	175,0 ⁽²⁾	152,0	158,0 ⁽²⁾	142,0	143,0 ⁽²⁾	131,0	131,0	122,0	122,0		210,0 ⁽¹⁾	158,0	193,0 ⁽¹⁾	
38		266,0 ⁽²⁾		232,0 ⁽²⁾	182,0	220,0 ⁽¹⁾	167,0	191,0 ⁽²⁾	156,0	172,0 ⁽²⁾	146,0	156,0 ⁽²⁾	137,0	142,0 ⁽²⁾	127,0	128,0 ⁽²⁾	118,0	118,0		205,0 ⁽²⁾		188,0 ⁽¹⁾	
40		268,0 ⁽²⁾		236,0 ⁽²⁾	175,0	217,0 ⁽¹⁾	161,0	188,0 ⁽²⁾	151,0	170,0 ⁽²⁾	141,0	154,0 ⁽²⁾	132,0	140,0 ⁽²⁾	122,0	126,0 ⁽²⁾	114,0	115,0 ⁽²⁾		203,0 ⁽²⁾		183,0 ⁽¹⁾	
44		270,0 ⁽²⁾		243,0 ⁽²⁾		217,0 ⁽²⁾	152,0	190,0 ⁽²⁾	140,0	166,0 ⁽²⁾	131,0	150,0 ⁽²⁾	123,0	136,0 ⁽²⁾	114,0	123,0 ⁽²⁾	107,0	112,0 ⁽²⁾		199,0 ⁽²⁾		175,0 ⁽²⁾	
48		249,0 ⁽²⁾		243,0 ⁽²⁾		221,0 ⁽²⁾	139,0	193,0 ⁽²⁾	134,0	168,0 ⁽²⁾	122,0	149,0 ⁽²⁾	115,0	133,0 ⁽²⁾	106,0	120,0 ⁽²⁾	100,0	109,0 ⁽²⁾		191,0 ⁽²⁾		171,0 ⁽²⁾	
52		228,0 ⁽²⁾		224,0 ⁽²⁾		216,0 ⁽²⁾		196,0 ⁽²⁾	123,0	171,0 ⁽²⁾	117,0	150,0 ⁽²⁾	107,0	133,0 ⁽²⁾	99,5	117,0 ⁽²⁾	93,9	106,0 ⁽²⁾		181,0 ⁽²⁾		164,0 ⁽²⁾	
56		209,0 ⁽²⁾		207,0 ⁽²⁾		201,0 ⁽²⁾		194,0 ⁽²⁾		174,0 ⁽²⁾	108,0	152,0 ⁽²⁾	104,0	134,0 ⁽²⁾	92,3	118,0 ⁽²⁾	87,2	105,0 ⁽²⁾		171,0 ⁽²⁾		157,0 ⁽²⁾	
60		189,0 ⁽²⁾		191,0 ⁽²⁾		186,0 ⁽²⁾		182,0 ⁽²⁾		170,0 ⁽²⁾	99,5	153,0 ⁽²⁾	96,4	136,0 ⁽²⁾	89,1	119,0 ⁽²⁾	81,6	106,0 ⁽²⁾		160,0 ⁽²⁾		149,0 ⁽²⁾	
64		169,0 ⁽²⁾		174,0 ⁽²⁾		172,0 ⁽²⁾		170,0 ⁽²⁾		162,0 ⁽²⁾		149,0 ⁽²⁾	88,7	134,0 ⁽²⁾	83,2	120,0 ⁽²⁾	78,9	106,0 ⁽²⁾		150,0 ⁽²⁾		141,0 ⁽²⁾	
68		150,0 ⁽²⁾		157,0 ⁽²⁾		157,0 ⁽²⁾		157,0 ⁽²⁾		155,0 ⁽²⁾		143,0 ⁽²⁾		131,0 ⁽²⁾	77,5	117,0 ⁽²⁾	74,2	107,0 ⁽²⁾		140,0 ⁽²⁾		134,0 ⁽²⁾	
72				140,0 ⁽²⁾		142,0 ⁽²⁾		143,0 ⁽²⁾		143,0 ⁽²⁾		139,0 ⁽²⁾		127,0 ⁽²⁾	72,1	115,0 ⁽²⁾	68,3	104,0 ⁽²⁾				126,0 ⁽²⁾	
76				124,0 ⁽²⁾		128,0 ⁽²⁾		131,0 ⁽²⁾		132,0 ⁽²⁾		131,0 ⁽²⁾		123,0 ⁽²⁾		111,0 ⁽²⁾	63,7	102,0 ⁽²⁾				118,0 ⁽²⁾	
80				113,0 ⁽²⁾		113,0 ⁽²⁾		118,0 ⁽²⁾		121,0 ⁽²⁾		121,0 ⁽²⁾		119,0 ⁽²⁾		106,0 ⁽²⁾		98,9 ⁽²⁾				109,0 ⁽²⁾	
84				102,0 ⁽²⁾		101,0 ⁽²⁾		105,0 ⁽²⁾		110,0 ⁽²⁾		111,0 ⁽²⁾		111,0 ⁽²⁾		105,0 ⁽²⁾		95,8 ⁽²⁾				99,1 ⁽²⁾	
88				91,7 ⁽²⁾		90,8 ⁽²⁾		92,6 ⁽²⁾		98,6 ⁽²⁾		101,0 ⁽²⁾		103,0 ⁽²⁾		99,3 ⁽²⁾		91,9 ⁽²⁾				89,2 ⁽²⁾	
92						81,1 ⁽²⁾		83,7 ⁽²⁾		87,5 ⁽²⁾		91,5 ⁽²⁾		94,1 ⁽²⁾		93,7 ⁽²⁾		90,1 ⁽²⁾				79,2 ⁽²⁾	
96						71,3 ⁽²⁾		74,8 ⁽²⁾		77,5 ⁽²⁾		81,6 ⁽²⁾		85,5 ⁽²⁾		85,8 ⁽²⁾		85,8 ⁽²⁾					
100								65,9 ⁽²⁾		69,4 ⁽²⁾		71,0 ⁽²⁾		76,9 ⁽²⁾		77,9 ⁽²⁾		80,0 ⁽²⁾					
104								55,9 ⁽²⁾		61,2 ⁽²⁾		63,5 ⁽²⁾		68,2 ⁽²⁾		70,1 ⁽²⁾		72,8 ⁽²⁾					
108								49,5 ⁽²⁾		53,1 ⁽²⁾		56,0 ⁽²⁾		59,9 ⁽²⁾		62,3 ⁽²⁾		65,7 ⁽²⁾					
112								43,0 ⁽²⁾				48,5 ⁽²⁾		52,8 ⁽²⁾		53,8 ⁽²⁾		58,6 ⁽²⁾					
116								36,6 ⁽²⁾				39,7 ⁽²⁾		45,8 ⁽²⁾		47,3 ⁽²⁾		51,4 ⁽²⁾					
120												34,1 ⁽²⁾		38,8 ⁽²⁾		40,7 ⁽²⁾		44,0 ⁽²⁾					
124												28,5 ⁽²⁾		31,5 ⁽²⁾		34,1 ⁽²⁾		37,8 ⁽²⁾					
128												23,0 ⁽²⁾		26,2 ⁽²⁾		26,5 ⁽²⁾		31,6 ⁽²⁾					
132														20,9 ⁽²⁾		21,5 ⁽²⁾		25,5 ⁽²⁾					
136														15,6 ⁽²⁾		16,5 ⁽²⁾							
140																11,5 ⁽²⁾							

1) 12° 2) 17° 3) 22° 4) 27° 5) 32° 6) 37° 7) 42° 8) 47° 9) 52° 10) 57° 11) 62°

Hubhöhen

PDW3B/PDW3BW

Lifting heights • Hauteurs de levage • Altezze di sollevamento • Alturas de elevación • Высота подъема

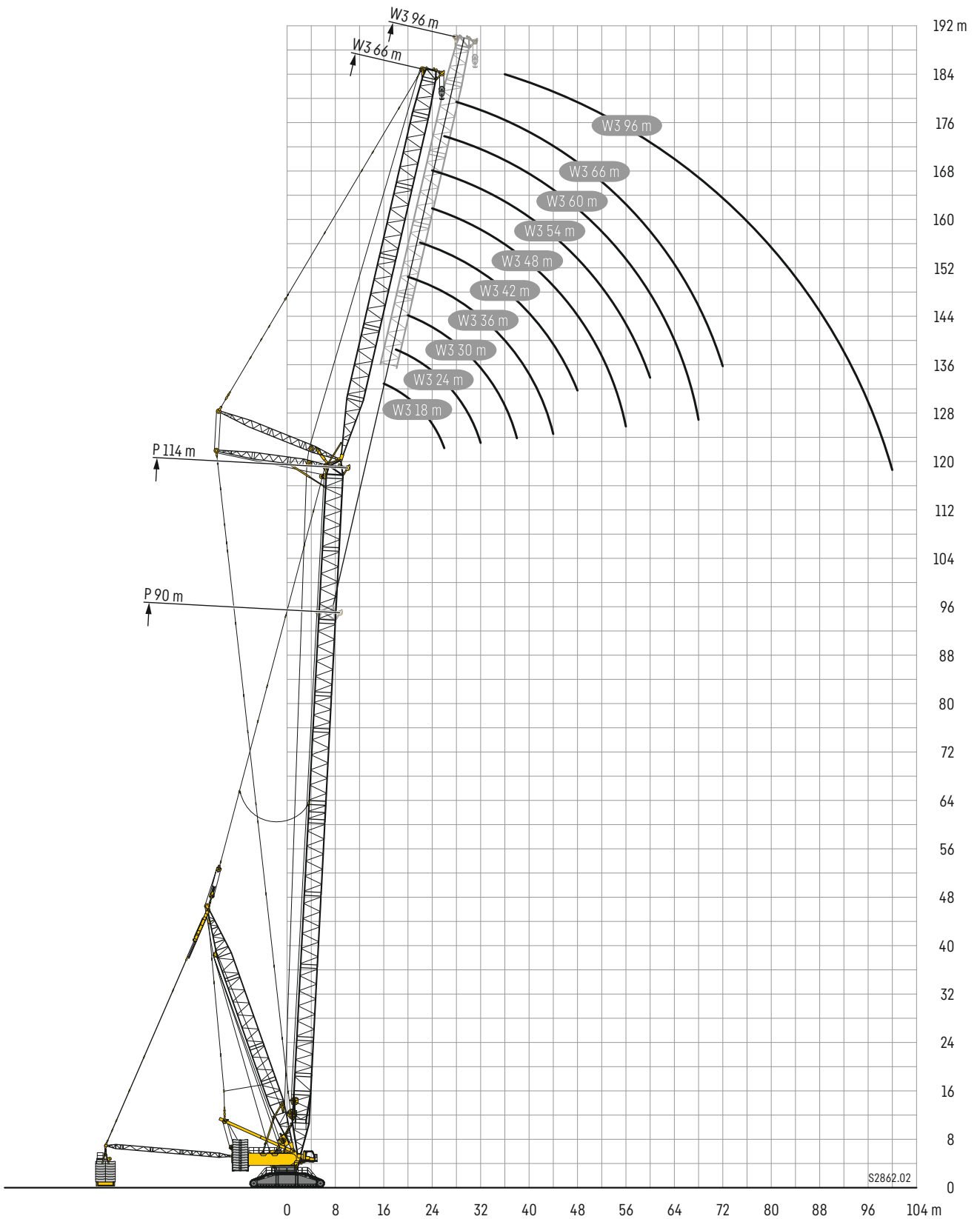

SL8F2

SL8 84 - 90



m	SL8 84 m		
	F2 12 m	F2 15 m	F2 18 m
	10°	10°	10°
15	253		
16	248		
17	233	232	
18	253	219	218
19	253	206	207
20	249	249	196
21	236	236	207
22	225	224	203
24	204	203	195
26	186	186	186
28	170	170	172
30	156	157	158
32	144	145	146
34	134	134	136
36	124	124	126
38	115	116	117
40	108	108	110
44	94	94,3	96,2
48	82,5	83	84,7
52	71,8	72,7	74,6
56	62,6	63,4	65,4
60	54,8	55,6	57,4
64	48	48,7	50,5
68	42,2	42,8	44,5
72	37	37,6	39,2
76	32,4	32,9	34,4
80	28,4	28,9	30,2
84			26,6

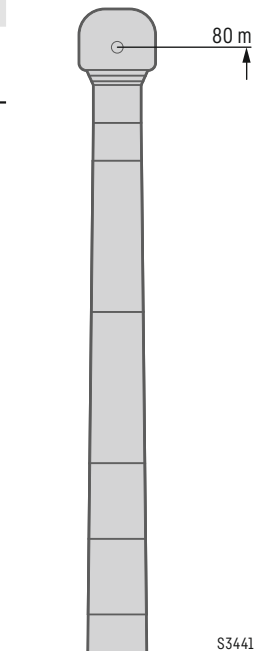

m	SL8 90 m		
	F2 12 m	F2 15 m	F2 18 m
	10°	10°	10°
16	240		
17	225	179	
18	253	211	
19	253	251	201
20	242	242	190
21	230	229	208
22	218	218	204
24	198	198	196
26	180	180	182
28	165	165	167
30	152	152	154
32	140	140	142
34	129	130	131
36	120	120	122
38	112	112	114
40	104	104	106
44	90,4	91	92,7
48	79,3	79,7	81,4
52	69,7	70	71,8
56	60,8	61,6	63,5
60	53	53,8	55,7
64	46,2	46,9	48,8
68	40,3	41	42,7
72	35,1	35,7	37,3
76	30,4	30,9	32,4
80	26,5	27	28,5
84	22,7	23,2	24,8
88		19,7	21
92			18,2
96			

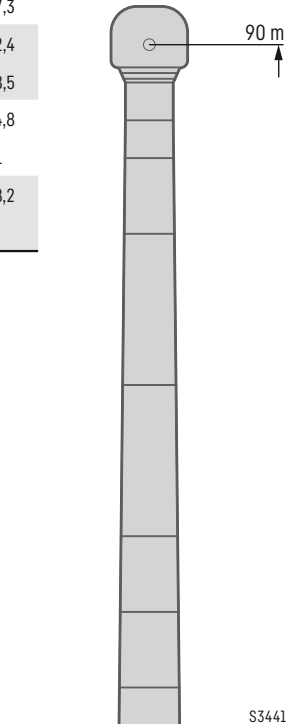

SL8F2

SL8 102

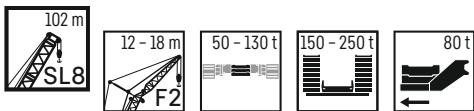

m	SL8 102 m		
	F2 12 m	F2 15 m	F2 18 m
	10°	10°	10°
17	253		
18	250		
19	240	231	
20	227	226	210
21	215	215	207
22	204	205	203
24	185	186	187
26	169	169	171
28	154	155	157
30	142	142	144
32	130	131	133
34	120	121	123
36	111	112	114
38	103	103	106
40	95,5	96	98,1
44	82,5	83	85,1
48	71,5	72,2	74,1
52	62,1	62,8	64,7
56	54,1	54,6	56,6
60	47,1	47,6	49,5
64	40,9	41,3	43,2
68	35,4	35,8	37,7
72	30,2	30,7	32,6
76	25,8	26,4	28,1
80	21,5	21,9	24
84	17,9	18,3	19,6
88	14,8	15,3	16,7
92	11,8	12,2	13,8
96	9,1	9,5	11
100			8,4

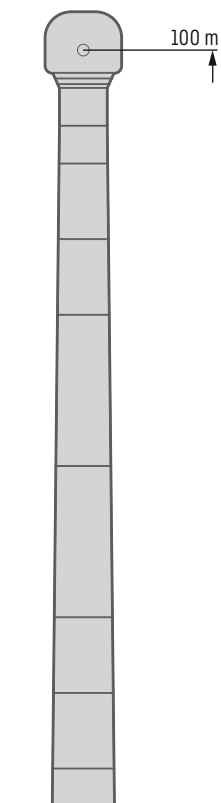

SL8F2



m	SL8 108 m		
	F2 12 m	F2 15 m	F2 18 m
	10°	10°	10°
18	233		
19	229	212	
20	219	210	
21	208	207	193
22	197	199	192
24	179	181	181
26	163	165	165
28	149	151	151
30	136	138	139
32	125	127	128
34	115	117	118
36	106	108	109
38	98,2	100	101
40	90,9	92,9	93,8
44	78,1	80,1	81
48	67,4	69,3	70,1
52	58,2	60	60,9
56	50,1	51,9	52,9
60	43,2	44,9	45,8
64	37	38,7	39,6
68	31,6	33,2	34,1
72	26,7	28,3	29,1
76	22,4	23,9	24,7
80	18,5	19,9	20,7
84	15	16,4	17,1
88	11,8	13,1	13,9
92	8,9	10,2	10,9
96	6,2	7,5	8,2
100			5,7

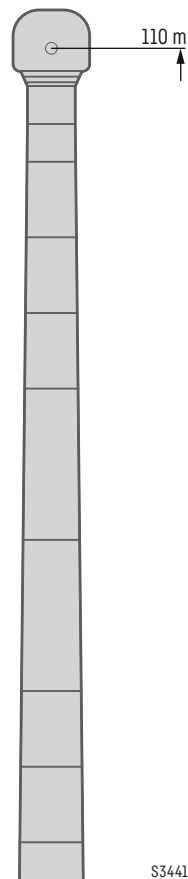

S3441

SL8 108

m	SL8 108 m	
	F2 18 m	
	10°	
18		
19		
20		
21	193	
22	192	
24	181	
26	165	
28	151	
30	139	
32	128	
34	118	
36	109	
38	101	
40	93,8	
44	81	
48	70,1	
52	60,9	
56	52,9	
60	45,8	
64	39,6	
68	34,1	
72	29,1	
76	24,7	
80	20,7	
84	17,1	
88	13,9	
92	10,9	
96	8,2	
100	5,7	

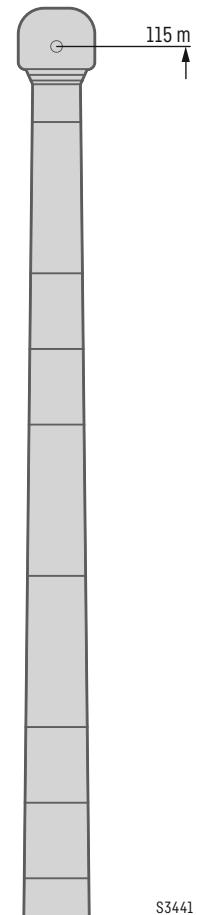

S3441

SL8F2

SL8 102

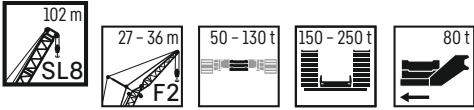

m	SL8 102	
	F2 27 m	F2 30 m
	10°	10°
17		
18		
19		
20		
21		
22		
24	140	
26	135	127
28	130	123
30	126	119
32	122	115
34	119	112
36	114	109
38	107	105
40	99,9	102
44	87	88,8
48	76,1	78
52	66,7	68,7
56	58,7	60,6
60	51,6	53,5
64	45,3	47,2
68	39,8	41,7
72	34,8	36,6
76	30,2	31,9
80	26,2	27,8
84	21,6	23,9
88	18,5	20
92	15,8	17,2
96	13,1	14,7
100	10,4	12
104	8	9,6
108	5,8	7,3
112		5,2

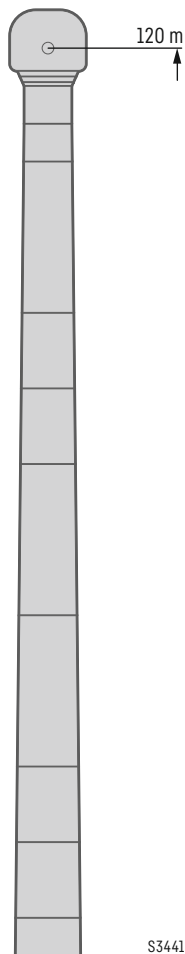

S3441

m	SL8 102	
	F2 36 m	
	10°	
17		
18		
19		
20		
21		
22		
24		
26	113	
28	109	
30	105	
32	102	
34	98,2	
36	95,3	
38	92,3	
40	89,4	
44	84,4	
48	77,5	
52	68,3	
56	60,3	
60	53,4	
64	47,2	
68	41,7	
72	36,7	
76	32,2	
80	28,2	
84	24,2	
88	20,4	
92	17,6	
96	15,1	
100	12,6	
104	10,1	
108	7,9	
112	5,8	

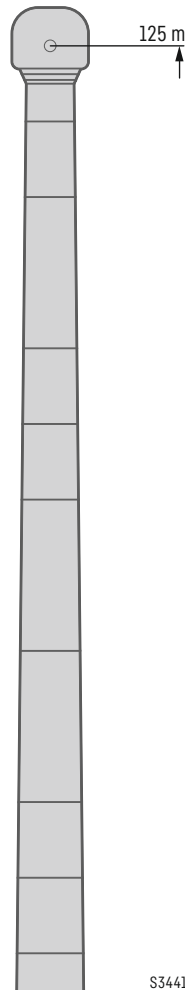

S3441

Hubhöhen

SL8F2

Lifting heights • Hauteurs de levage • Altezze di sollevamento • Alturas de elevación • Высота подъема

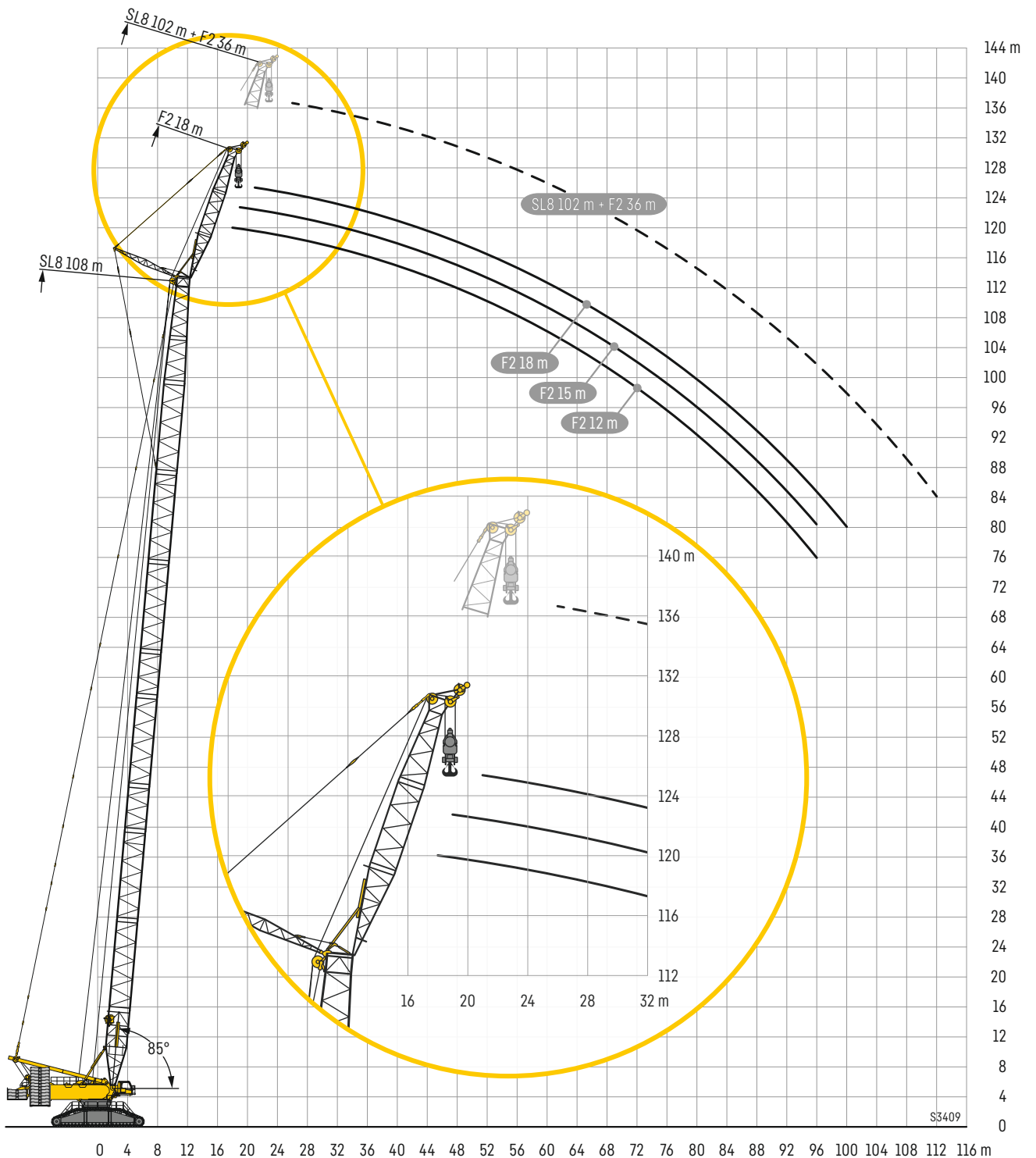

SL10DF2B/BV

SL10 150

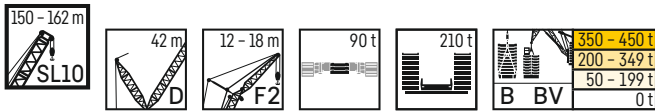

m	SL10 150 m		
	F2 12 m 10°	F2 15 m 10°	F2 18 m 10°
20	114		
B	172		
BV			
22	112	114	
B	182	170	
BV	183		
24	99,2	101	103
B	181	169	159
BV	183	172	
26	87,5	89,5	91,3
B	179	168	158
BV	183	171	160
28	77,3	79,3	81
B	177	167	157
BV	182	171	159
30	68,3	70	72
B	175	165	155
BV	182	170	158
32	60,1	61,9	63,7
B	174	164	154
BV	181	169	157
34	52,6	54,5	56,1
B	173	163	153
BV	180	169	157
36	46,1	47,7	49,5
B	171	161	151
BV	179	168	155
38	40	41,6	43,4
B	169	160	150
BV	178	166	154
40	34,4	36,1	37,7
B	168	158	148
BV	177	164	153
44	24,6	26,1	27,8
B	163	153	144
BV	173	161	150
48	16,2	17,7	19,3
B	157	148	140
BV	169	157	147
52	10,4	12	12
B	152	143	135
BV	164	153	143
56	146	137	130
B	159	148	139
60	139	133	125
B	154	143	134
64	128	126	120
B	150	139	130
68	116	117	114
B	145	135	126
72	106	107	108
B	141	131	123
76	96,6	98	99,3
B	136	127	119
80	88	89,2	90,7
B	130	123	115
88	73,2	74,1	75,5
B	114	113	109
96	60,7	61,8	63
B	98,1	99,1	100
104	50	50,8	52
B	84,7	85,3	86,6
112	40,7	41,4	42,7
B	73,1	73,8	75,2
120	32,6	33,3	34,4
B	62,8	63,8	65
128	25,4	26	26,9
B	50,9	54,2	56
136			20,5
B			47,8
144			
B			
BV			

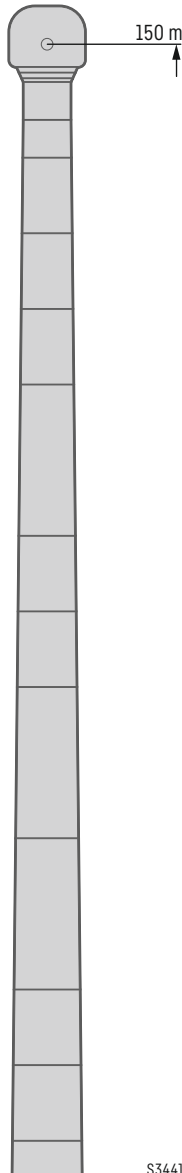

S3441

m	SL10 162 m		
	F2 12 m 10°	F2 15 m 10°	F2 18 m 10°
24			
B			
BV	156		
26			
B			
BV	155	146	138
28			
B			
BV	155	145	138
30			
B			
BV	154	145	137
32			
B			
BV	153	144	137
34			
B			
BV	152	143	136
36			
B			
BV	152	143	135
38			
B			
BV	151	142	135
40			
B			
BV	150	141	134
44			
B			
BV	149	140	133
48			
B			
BV	147	139	131
52			
B			
BV	146	137	128
56			
B			
BV	143	134	126
60			
B			
BV	140	131	123
64			
B			
BV	136	127	120
68			
B			
BV	133	124	117
72			
B			
BV	130	121	114
76			
B			
BV	127	119	112
80			
B			
BV	122	115	109
88			
B			
BV	106	106	104
96			
B			
BV	91	91,9	94
104			
B			
BV	77,7	78,8	81,3
112			
B			
BV	66,2	67,1	69,3
120			
B			
BV	56,1	56,8	59,3
128			
B			
BV	47,3	48,1	50,4
136			
B			
BV	39,6	40,3	42,3
144			
B			
BV		33,3	35,3
152			
B			
BV			

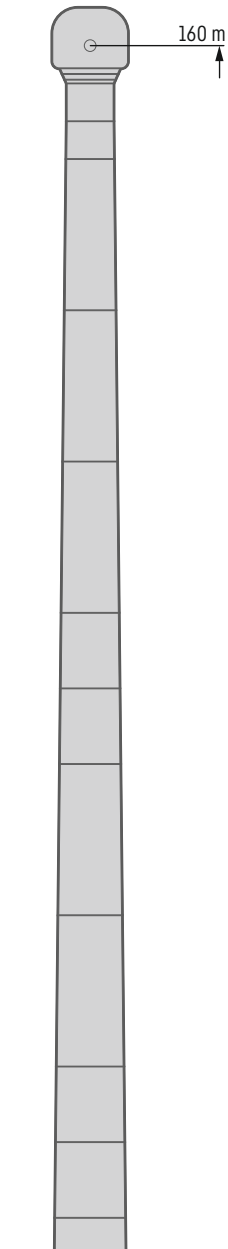

SL10DF2B/BV

SL10 162 - 168

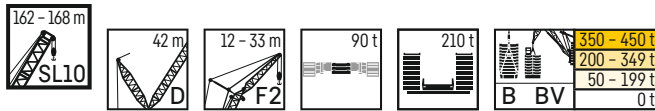

m	SL10 168 m		
	F2 12 m 10°	F2 15 m 10°	F2 18 m 10°
24	140		
26	139	132	118
28	139	131	124
30	138	131	123
32	137	130	123
34	136	129	122
36	136	129	122
38	135	128	121
40	134	127	121
44	133	126	119
48	131	125	118
52	130	123	116
56	128	121	113
60	125	118	111
64	122	115	109
68	119	112	106
72	116	110	104
76	113	107	102
80	110	105	99,3
88	102	99,6	94,8
96	87,7	89,9	88,8
104	75	77,2	78,2
112	63,2	65,4	66,8
120	53,2	55,4	56,6
128	44,1	46,4	47,6
136	33,3	37,7	39,5
144	20,1	24,6	29,2
152			18,5

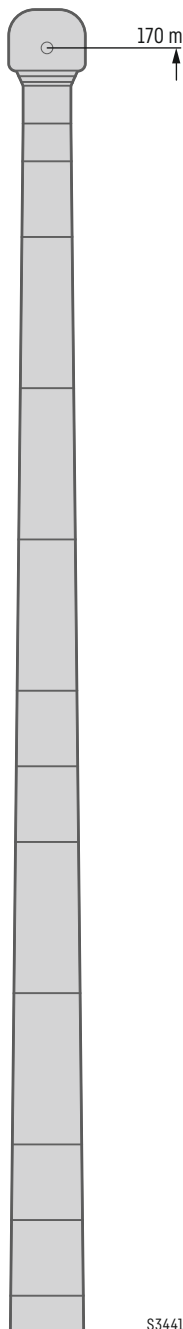

S3441

m	SL10 162 m		
	F2 27 m 10°	F2 30 m 10°	F2 33 m 10°
30	114	107	
32	113	106	98,7
34	113	105	97,9
36	112	104	97,1
38	111	103	96,3
40	110	103	95,4
44	108	101	93,7
48	107	99,3	92,1
52	105	97,1	89,9
56	102	93,7	86,4

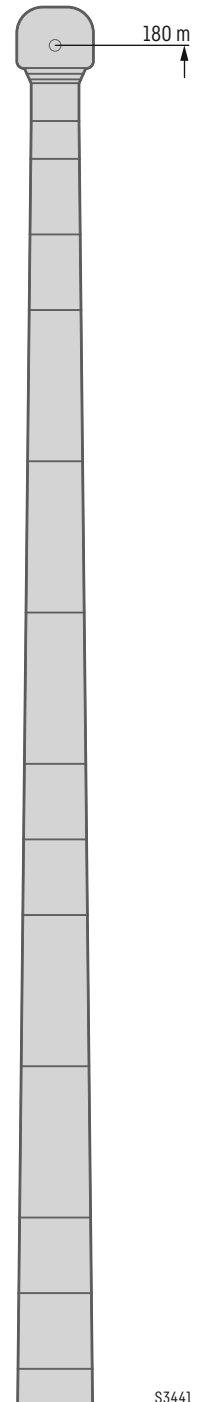

S3441

m	SL10 168 m		
	F2 18 m 10°	F2 21 m 10°	F2 24 m 10°
24			
26	118		
28	124	117	
30	123	116	110
32	123	116	110
34	122	115	109
36	122	115	109
38	121	114	108
40	121	114	108
44	119	112	106

SL10DF2B/BV

SL10 162

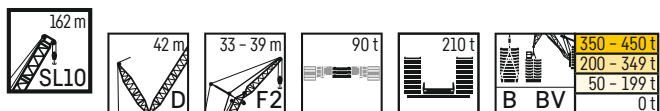

m	SL10 162 m		
	F2 33 m 10°	F2 36 m 10°	F2 39 m 10°
30			
B			
BV			
32			
B	98,7	92,6	86,5
BV			
34			
B	97,9	91,7	85,7
BV			
36			
B	97,1	90,9	85
BV			
38			
B	96,3	90,1	84,2
BV			
40			
B	95,4	89,2	83,4
BV			
44			
B	93,7	87,6	81,8
BV			
48			
B	92,1	86	80,2
BV			
52			
B	89,9	84	78,5
BV			
56			
B	86,4	80,7	75,9
BV			
60			
B	83,1	77,4	72,7
BV			
64			
B	80	74,4	69,8
BV			
68			
B	76,9	71,5	66,9
BV			
72			
B	74	68,7	64,3
BV			
76			
B	71,3	66	61,7
BV			
80			
B	68,9	63,8	59,4
BV			
88			
B	64,8	59,7	55,5
BV			
96			
B	61,1	56,1	52
BV			
104			
B	57,7	53	48,8
BV			
112			
B	54,9	50,3	46,2
BV			
120			
B	52,3	47,9	43,9
BV			
128			
B	49,3	45,7	41,7
BV			
136			
B	45,5	43,8	40
BV			
144			
B	39	39	37,2
BV			
152			
B	32,5	33,2	33,2
BV			
160			
B	26,7	27,4	27,7
BV			

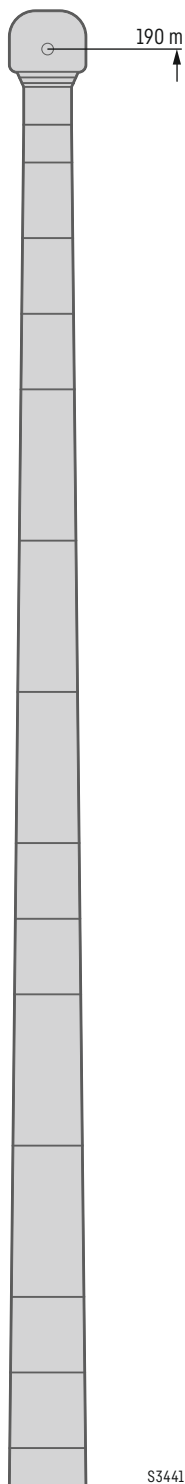

S3441



Hubhöhen

SL10DF2B/BV

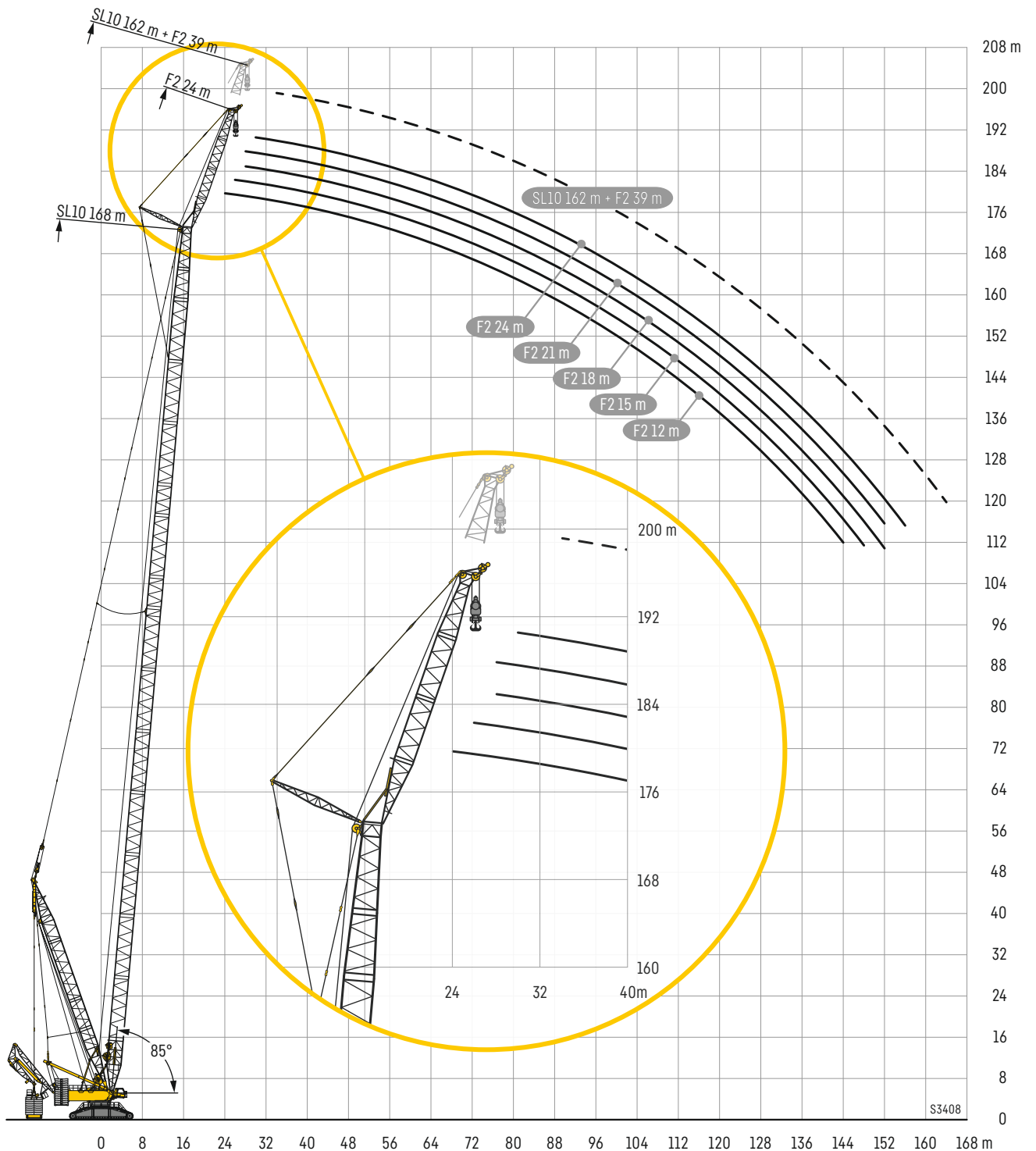
Lifting heights • Hauteurs de levage • Altezze di sollevamento • Alturas de elevación • Высота подъема

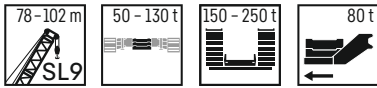



		SL9 78 - 102 m						
 m		78 m	84 m	90 m	96 m	102 m	 m	
11		386						11
12		351	338					12
13		409	310	298	288			13
14		378	365	353	341	330		14
15		351	340	328	318	307		15
16		326	317	306	297	287		16
17		305	296	286	278	269		17
18		286	278	268	261	252		18
19		269	261	253	245	238		19
20		253	246	238	232	224		20
21		239	233	225	219	212		21
22		226	220	213	207	201		22
24		204	198	191	186	181		24
26		184	179	173	169	163		26
28		168	163	158	153	148		28
30		153	149	144	140	135		30
32		141	136	132	128	123		32
34		129	126	121	117	113		34
36		119	116	111	108	104		36
38		110	107	102	99,4	95,2		38
40		102	98,9	94,6	91,5	87,8		40
44		86,2	84,9	81,1	78,2	74,6		44
48		73,5	72,2	69,7	67	63,4		48
52		63	61,7	59,4	57,4	53,9		52
56		54,2	52,9	50,5	49,1	45,9		56
60		46,8	45,3	42,9	41,5	38,8		60
64		40,5	38,9	36,4	35	32,6		64
68		35,1	33,4	30,8	29,3	27		68
72			28,6	25,9	24,3	22		72
76				21,6	20	17,5		76
80					16,1	13,6		80
84					12,7	10,1		84
88						7,1		88

Hubhöhen

SL9

Lifting heights • Hauteurs de levage • Altezze di sollevamento • Alturas de elevación • Высота подъема

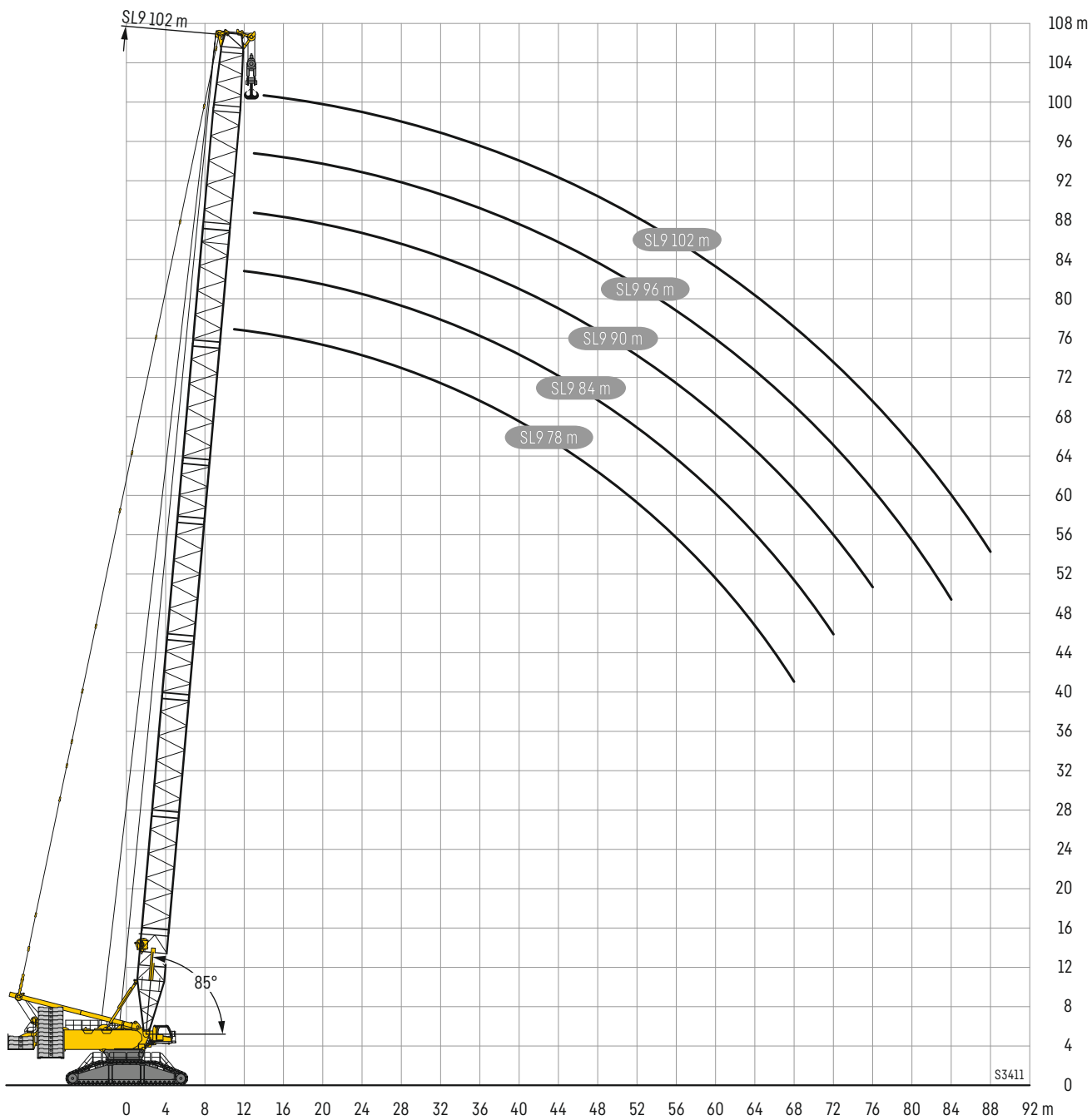

SL11DB/BV

SL11 66 - 162

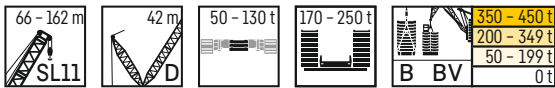

		SL11 66 - 162 m																
m		66 m	72 m	78 m	84 m	90 m	96 m	102 m	108 m	114 m	120 m	126 m	132 m	138 m	144 m	150 m	156 m	162 m
10	B	650																
	BV																	
11	B	650	650	650														
	BV																	
12	B	650	650	650	641	590												
	BV																	
13	B	650	650	650	639	589	536	488										
	BV																	
14	B	650	650	650	637	586	534	486	442	400								
	BV																	
15	B	650	650	650	628	585	533	485	440	399	372	338						
	BV																	
16	B	650	650	644	612	579	531	484	440	398	371	337	307	272				
	BV	650	650	650	650	598	549	498	450	407	378	343						
17	B	650	643	625	597	567	530	483	439	397	371	337	307	275	249			
	BV																	
18	B	641	628	606	581	554	523	481	437	396	370	336	306	276	249			
	BV	650	650	650	633	596	550	499	451	408	379	343	312	279	252	234	209	
19	B	618	606	587	564	539	512	479	436	396	369	336	306	275	247			
	BV																	
20	B	588	580	568	546	524	500	474	435	395	368	335	305	275	246			
	BV	650	650	631	605	576	544	499	452	408	380	344	312	280	253	231	209	188
22	B	536	529	521	510	498	480	457	427	392	366	333	303	272	246			
	BV	624	618	600	576	553	526	496	452	409	380	344	312	280	253	230	208	187
24	B	491	485	478	471	464	455	439	410	387	363	330	300	270	243			
	BV	575	570	567	550	530	507	482	447	409	380	344	311	280	253	229	207	185
26	B	451	447	441	435	429	423	415	394	375	357	326	296	267	241			
	BV	544	530	522	519	507	488	466	435	407	380	343	309	279	252	227	206	184
28	B	418	413	408	403	399	392	387	377	361	347	321	293	264	239			
	BV	517	504	489	480	478	467	450	424	398	377	338	307	277	251	226	204	183
30	B	388	384	379	375	370	366	361	354	345	334	317	289	260	236			
	BV	491	480	466	453	444	441	433	407	387	370	332	305	275	249	224	203	182
32	B	361	358	353	349	346	341	338	332	326	318	307	286	257	233			
	BV	466	457	445	433	423	412	408	391	375	360	325	303	273	247	223	202	180
34	B	338	334	330	326	323	319	316	311	306	300	292	280	254	230			
	BV	440	433	424	414	405	394	384	368	360	349	319	301	271	245	221	200	179
36	B	317	313	309	305	303	299	297	292	288	282	276	270	249	227			
	BV	414	410	403	395	387	378	368	349	341	334	311	299	269	244	220	199	178
38	B	298	295	290	286	284	281	279	275	271	266	261	257	242	223			
	BV	391	387	381	376	370	362	354	334	324	318	302	296	267	242	218	198	178
40	B	281	278	273	270	267	264	262	259	256	251	247	244	233	217			
	BV	370	366	361	356	353	346	339	322	312	303	292	286	264	240	217	197	177
44	B	247	248	244	241	238	235	234	230	228	223	220	218	212	204			
	BV	332	329	324	320	318	314	310	299	291	283	273	268	254	235	215	195	175
48	B	216	220	220	216	214	211	209	206	204	200	197	196	191	188			
	BV	302	298	294	289	287	284	281	276	270	263	256	253	242	229	213	194	173
52	B	187	197	198	196	193	190	188	186	183	179	177	176	171	170			
	BV	269	272	267	264	261	258	256	249	244	238	236	228	220	208	191	171	
56	B	166	174	176	177	176	173	171	168	165	161	159	158	154	153			
	BV	241	249	245	241	239	236	233	230	227	223	220	219	212	208	199	188	169
60	B		155	158	161	159	157	155	152	150	146	144	143	138	138			
	BV		223	225	222	219	217	215	211	208	204	202	201	196	193	186	180	166
64	B		136	141	143	142	143	142	139	136	132	130	130	125	124			
	BV		200	206	205	203	199	198	194	191	187	185	184	179	178	172	169	159
68	B			123	126	129	130	130	127	124	121	118	117	113	112			
	BV			186	189	187	184	182	179	177	173	170	169	165	164	157	156	151
72	B				115	117	119	119	116	114	110	108	107	102	102			
	BV				171	174	171	169	166	163	160	157	156	151	150	145	143	140
76	B					107	108	107	107	104	100	98,3	97,3	92,6	91,8			
	BV					160	159	157	154	151	147	145	144	139	138	133	132	129
80	B						93,5	93,8	96,8	94,2	91,8	89,4	88,8	84,2	83,2			
	BV						148	146	143	140	136	134	134	129	128	122	121	118
88	B							77,2	78	78,3	76,9	74,6	73,6	69	68,6			
	BV							125	124	122	118	115	114	110	109	103	102	99,4
96	B								65,2	64,4	62,2	60,9	56,7	55,9				
	BV								106	102	99,6	98,5	94,3	93	87,2	87,1	84,2	
104	B									52,8	51,8	50,5	46,2	45,1				
	BV									86,4	86,5	85,2	81	78	74,3	73,5	70,2	
112	B												41,5	37,2	36,1			
	BV												73,7	69,6	62,4	62,9	61,7	57,1
120	B													29,5	28,3			
	BV													59,8	50,8	52,9	52	43,2
128	B															44,4	42,4	30
	BV																	
136	B																	
	BV																	20

Hubhöhen



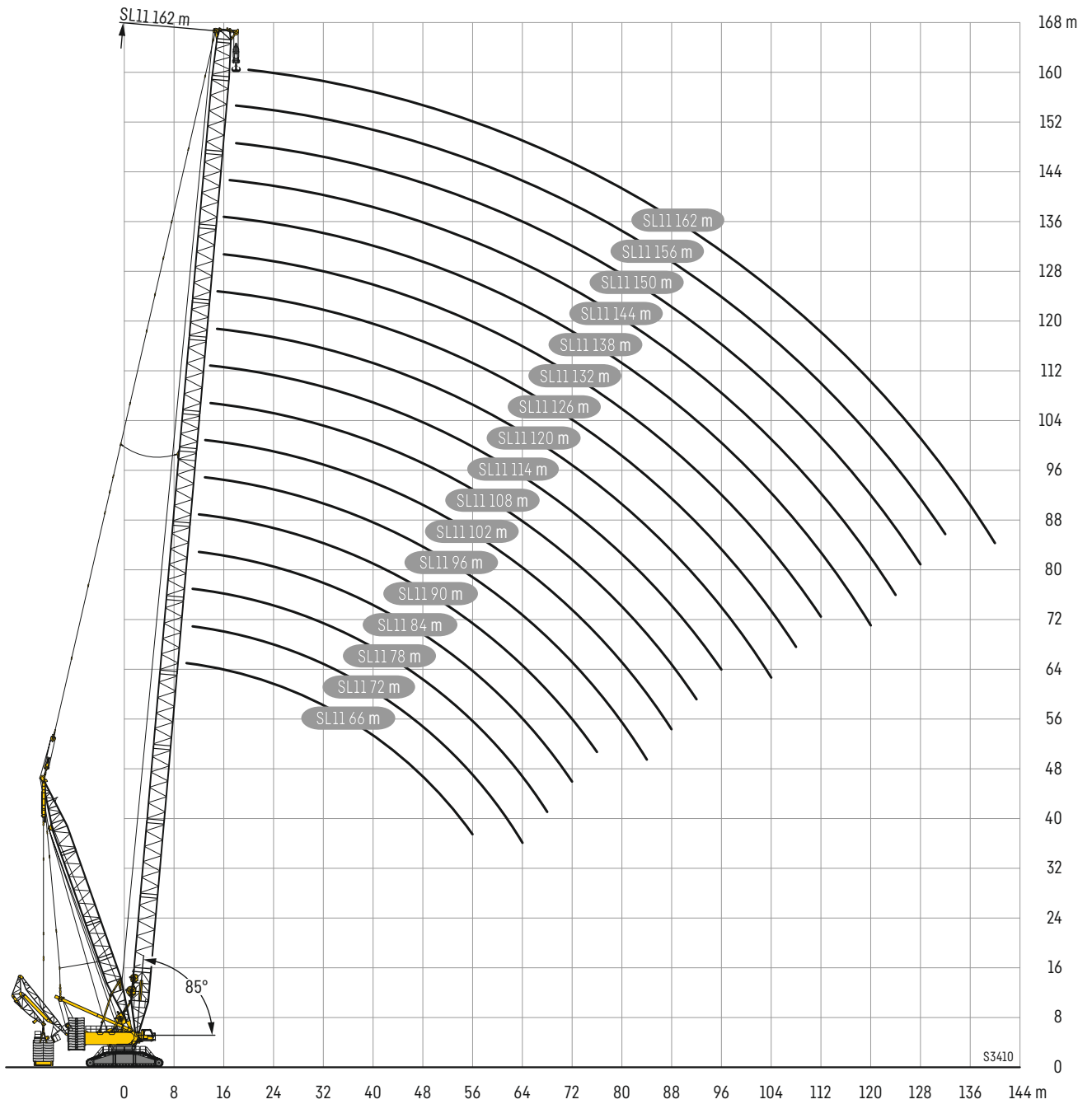

SL11DB/BV

Lifting heights • Hauteurs de levage • Altezze di sollevamento • Alturas de elevación • Высота подъема



Symbolerklärung

Description of symbols · Explication des symboles · Legenda simboli
 Descripción de los símbolos · Объяснение символов

	Max. Tragkraft Max. capacity Capacité max. Capacità max. Máx. capacidad de carga Макс. грузоподъемность		Gewicht Weight Poids Peso Peso Собст. вес
	Maximale Länge Hauptausleger Max. boom length Longueur maxi. de la fleche principale Massima lunghezza braccio principale Longitud maxima pluma principal Максимальная длина основной стрелы		Stränge No. of lines Brins Tratti portanti Reenvios Запасовка
	Maximale Länge Auslegersystem Max. boom system length Longueur maxi. du système de fleche Massima lunghezza sistema braccio Longitud maxima sistema de plumas Максимальная длина стреловой системы		Rollen No. of sheaves Poulies Pulegge Poleas Канатных блоков
	Gegengewicht Counter weight Contrepoids Contrappeso Contrapeso Противовес		Ausladung Radius Portée Raggio di lavoro Radio de trabajo Вылет стрелы
	Zentralballast Central ballast Contrepoids central Zavorra centrale Contrapeso central Центральный балласт		Hauptausleger SL/SL2/SL8/SL9/SL10/SL11 Main boom SL/SL2/SL8/SL9/SL10/SL11 Fleche principale SL/SL2/SL8/SL9/SL10/SL11 Braccio principale SL/SL2/SL8/SL9/SL10/SL11 Pluma principal SL/SL2/SL8/SL9/SL10/SL11 Основная стрела SL/SL2/SL8/SL9/SL10/SL11
	Breite Raupenfahrwerk Width crawler chassis Largeur du train de chenilles Larghezza carro cingolato Chasis sobre cadenas ancho Ширина гусеничного механизма перемещения		Hauptausleger S/S2 Main boom S/S2 Fleche principale S/S2 Braccio principale S/S2 Pluma principal S/S2 Основная стрела S/S2
	Hubwerk Hoist gear Treuil de levage Argano Cabrestante Механизм подъема		Derricksystem D Derrick system D Système derrick D Sistema Derrick D Sistema Derrick D Дerrick-система D
	Geschwindigkeiten Working speeds Vitesses Velocità Velocidades Скорости		Hauptausleger P Main boom P Fleche principale P Braccio principale P Pluma principal P Основная стрела P
	Max. Seilzug Max. single line pull Effort au brin maxi. Mass. tiro diretto fune Tiro max. en cable Макс. тяговое усилие		Hauptausleger SL Main boom SL Fleche principale SL Braccio principale SL Pluma principal SL Основная стрела SL
	Seildurchmesser Rope diameter Diamètre Diametro Diámetro Диаметр		Hauptausleger SL Main boom SL Fleche principale SL Braccio principale SL Pluma principal SL Основная стрела SL
	Seillänge Rope length Longueur du câble Lunghezza fune Longitud cable Длина каната		Feste Gitterspitze F2 Fixed lattice jib F2 Flechette a treillis fixe F2 Falcone tralicciato fisso F2 Plumin fijo de celosia F2 Неподвижный решетчатый удлинитель F2
	Drehgeschwindigkeiten Slewing speeds Vitesses d'orientation Velocità di rotazione Velocidades de giro Скорости вращения		Ballastpalette B Counterweight frame B Palette de lest B Telaio per contrappeso B Bandeja de contrapeso B Основание противовеса B
	Fahrgeschwindigkeit Driving speed Vitesse de translation Velocità su strada Velocidad Скорость передвижения		Schwebeballast V-frame Suspended ballast V-frame V-Frame de contrepoids suspendu Telaio a V per zavorra sospesa Bandeja de contrapeso V suspendida Подвесной балласт V-frame
	Traglast Load Forces de levage Portata Capacidad de carga Грузоподъемность		Ballastwagen BW Counterweight trailer BW Remorque à contrepoids BW Carrello contrappeso BW Carro de contrapeso BW Балластная тележка BW
	Hakenflasche/Traglast Hookblock/Capacity Moufle à crochet/Capacité de charge Bozzello/Portata Pasteca/Capacidad de carga Крюковая подвеска/грузоподъемность		Drehbühnenballastverlängerung Extension of slewing platform ballast Extension de lest de partie tournante Prolongamento zavorra piattaforma girevole Prolongación de contrapeso en superestructura Удлинение рамы балласта поворотной платформы

Anmerkungen

1. Die Traglasttabellen sind berechnet nach EN 13000.
2. Bei der Berechnung der Traglasttabellen ist mindestens eine Windgeschwindigkeit von 9 m/s (39,9 km/h) und bezüglich der Last eine Windfläche von 1 m² pro Tonne Last und ein Windwiderstandsbeiwert der Last von 1,2 berücksichtigt. Beim Heben von Lasten mit großer Windangriffsfläche und/oder hohen Windwiderstandsbeiwerten muss die in den Traglasttabellen angegebene max. Wind-geschwindigkeit reduziert werden.
3. Traglasten für Einsatz als Montagekran (entspricht Kraneinstufung nach ISO 4301-1, Krangruppe A1).
4. Die Traglasten sind in Tonnen angegeben.
5. Das Gewicht des Lashakens bzw. der Hakenflasche ist Teil der Last und ist daher von den Traglasten abzuziehen.
6. Die Ausladungen sind von der Drehmitte aus gemessen.
7. Die Aufstandsfläche muß eben und tragfähig sein.
8. Traglaständerungen vorbehalten.
9. Die Daten dieser Broschüre dienen zur allgemeinen Information. Sämtliche Angaben erfolgen ohne Gewähr. Anweisungen zur ordnungsgemäßen Inbetriebnahme des Krans entnehmen Sie bitte der Betriebsanleitung und dem Traglasttabellenbuch.
10. Die Abbildungen enthalten auch Zubehör und Sonderausstattungen, die nicht zum serienmäßigen Lieferumfang gehören.

Remarques

1. Les tableaux des charges sont calculés selon EN 13000.
2. Une vitesse de vent de 9 m/s (33 km/h) minimum, une surface de prise au vent de 1 m² par tonne ainsi qu'un coefficient de résistance au vent de la charge 1,2 sont pris en compte pour le calcul des tableaux de charge. Lorsque des charges ayant une surface de prise au vent et/ou un coefficient de résistance au vent plus élevé(e)s sont levées, la vitesse de vent maximale indiquée dans les tableaux de charge doit être réduite.
3. Forces de levage pour application de grue de montage (correspond à la classification de grues selon ISO 4301-1, groupe de grues A1).
4. Les charges sont indiquées en tonnes.
5. Le poids du crochet de levage resp. de la moufle à crochet est une partie de la charge et doit donc être déduit de la capacité de charge.
6. Les portées sont calculées à partir de l'axe de rotation.
7. Le sol doit être plat et résistant.
8. Charges données sous réserve de modification.
9. Les données de cette brochure sont données à titre informatif. Ces renseignements sont sans garantie. Les consignes relatives à la bonne mise en service de la grue sont disponibles dans le manuel d'utilisation et le manuel de tableaux de charge.
10. Les figures contiennent également des accessoires et des équipements spéciaux non inclus de série dans la livraison.

Observaciones

1. Las tablas de carga se calculan según EN 13000.
2. En el cálculo de las tablas de carga se ha tenido en cuenta una velocidad del viento mínima de 9 m/s (39,9 km/h) y con respecto a la carga una superficie expuesta al viento de 1 m² por tonelada de carga y un coeficiente de la resistencia del viento de la carga de 1,2. A la hora de elevar cargas con superficies grandes expuestas al viento y/o coeficientes altos de la resistencia al viento hay que reducir las velocidades máx. del viento indicadas en las tablas de cargas.
3. Capacidades de carga para uso como grúa de montaje (de acuerdo con la clasificación de grúas conforme a la norma ISO 4301-1, grupo de grúas A1).
4. Las capacidades de carga se indican en toneladas.
5. El peso del gancho o de la pasteca está incluido en la carga y debe de ser restado de la capacidad de carga.
6. Los radios de trabajo deben de ser medidos desde el centro.
7. La superficie de apoyo ha de ser llana y firme.
8. Las capacidades de carga están sujetas a modificaciones.
9. Los datos de este folleto sirven de información general y están sujetos a modificaciones. Rogamos consulten las instrucciones sobre el correcto funcionamiento de la grúa en el manual y el listado de tablas de carga.
10. Las ilustraciones incluyen equipamiento adicional y especial, que no vienen de serie.

Remarks

1. The load charts are calculated according to EN 13000.
2. For the calculation of the load charts at least a wind speed of 9 m/s (39.9 km/h) and regarding the load a sail area of 1 m² per ton load and a wind resistance coefficient of 1.2 on the load have been taken into account. For lifting of loads with large sail areas and/or high wind resistance coefficients the maximum wind speed as stated in the load charts has to be reduced.
3. The lifting capacities stated are valid for lifting operation only (corresponding with crane classification according to ISO 4301-1, crane group A1).
4. Lifting capacities are given in metric tons.
5. The weight of the hook blocks and hooks is part of the load and therefore it must be deducted from the lifting capacities.
6. Working radii are measured from the slewing centre.
7. The subsoil must be even and of good bearing capacity.
8. Subject to modification of lifting capacities.
9. The data of this brochure serves only for general information. All information is provided without warranty. Instructions for the correct commissioning of the crane please take from the operation manual and the load chart book.
10. The pictures contain also accessories and special equipment not included in the standard scope of delivery.

Note

1. Le tabelle sono calcolate secondo la norma EN 13000.
2. Per il calcolo delle tabelle di portata bisogna considerare una velocità minima del vento di 9 m/s (39,9 km/h) e relativamente al carico, una superficie esposta al vento di 1 m² per tonnellata sollevata e un coefficiente di resistenza al vento di 1,2 sul carico. Durante il sollevamento del carico con superficie esposta al vento molto vasta e/o coefficienti di resistenza del vento molto alti, la velocità massima del vento indicata nelle tabelle di portata deve essere ridotta.
3. Carichi massimi per l'impiego come gru da montaggi (corrisponde alla classificazione ISO 4301-1, gruppo A1).
4. Le portate sono indicate in tonnellate.
5. Il peso del gancio e/o del bozzello sono da considerarsi parte del carico, per cui sono da sottrarre dalle tabelle.
6. I raggi di lavoro sono misurati dal centro ralla.
7. La superficie adibita al montaggio deve essere piana e in grado di sopportare il carico.
8. Con riserva di modifiche delle portate.
9. I dati di questo prospetto sono utili come informazione generale. Tutte le indicazioni vengono fornite senza garanzia. Si prega di desumere le istruzioni per la messa in servizio della gru dal manuale di istruzioni per l'uso e dal manuale delle tabelle di carico.
10. Le illustrazioni contengono anche accessori ed equipaggiamento speciale che non appartengono alle dotazioni di serie.

Замечания

1. Таблицы грузоподъемности рассчитаны согласно EN 13000.
2. При расчете таблиц грузоподъемности приняты минимальная скорость ветра 9 м/с (39,9 км/час), парусность (ветровая площадь) груза 1 кв. м на тонну поднимаемого груза и коэффициент воздушного сопротивления груза 1,2. При подъеме грузов с большей парусностью и/или с высоким коэффициентом воздушного сопротивления необходимо уменьшить указанное в таблицах грузоподъемности значение максимальной скорости ветра.
3. При использовании в качестве монтажного крана таблицы грузоподъемности отвечают требованиям ИСО 4301-1, группа крана А1.
4. Значения грузоподъемности даны в тоннах.
5. Вес грузового крюка и/или крюковой подвески является частью груза и поэтому должен быть вычтен из значения грузоподъемности.
6. Вылет измерен от центра вращения.
7. Изменения значений грузоподъемности возможны.
8. Возможно изменение значений грузоподъемности.
9. Данная брошюра предназначена для общего информирования. Все без исключения данные приведены без обязательств по их соблюдению. Инструкции по надлежащему вводу крана в эксплуатацию находятся в руководстве по эксплуатации и в таблицах грузоподъемности.
10. На иллюстрациях изображены комплектующие узлы и специальное оборудование, не относящиеся к объему серийных поставок.

Customer Service

Persönlich. Kompetent. Zuverlässig.

Personal. Competent. Reliable.

Personnalisé. Compétent. Fiable.

Personalizzato. Competente. Affidabile.

Personalizado. Cualificado. Fiable.

Персонально. Грамотно. Надежно.

Damit Ihr Liebherr ein Liebherr bleibt.

To ensure your Liebherr remains a Liebherr.

De sorte que votre Liebherr reste une Liebherr.

Così la tua Liebherr rimane una Liebherr.

Para que tu Liebherr siga siendo Liebherr.

Ваш Либхерр всегда остается Либхерром.

- **Kranübergabe und Einweisung durch erfahrene Service Monteure**
- **Weltweites Servicenetz mit über 80 eigenen Standorten**
- **24/7 technischer Support weltweit**
- **Schnelle Verfügbarkeit von Ersatzteilen**
- **Attraktive Pakete für Wartungs- und Serviceleistungen**

- Mise en route et formation effectuées par des techniciens qualifiés
- Service-Après-Vente Mondial représenté par plus de 80 correspondants
- Assistance Technique 24/24 et 7/7 jours
- Rapide disponibilité des pièces de rechanges
- Kits d'entretiens pour révisions et maintenances à un prix attractif

- Entrega de las grúas e instrucciones de manejo realizado por técnicos de servicio experimentados.
- Red de servicio mundial con presencia en más de 80 ubicaciones.
- 24/7 de soporte técnico a nivel mundial
- Disponibilidad inmediata de piezas de repuesto
- Ofertas atractivas de paquetes de mantenimiento y servicio

- Commission and training by experienced service technicians
- Worldwide service network with over 80 branches
- 24/7 technical support worldwide
- Fast availability of spare parts
- Attractive packages for maintenance and service

- Consegna della gru e formazione da parte di tecnici esperti di assistenza
- Rete di assistenza in tutto il mondo, con oltre 80 sedi
- Supporto tecnico 24/7 in tutto il mondo
- Ricambi disponibili in tempi rapidi
- Pacchetti interessanti di servizi di manutenzione e assistenza

- Передача крана и обучение опытными специалистами по обслуживанию
- Всемирная сервисная сеть с более чем 80 собственными офисами
- 24/7 техническая поддержка по всему миру
- Быстрая доступность запчастей
- Привлекательные пакеты для обслуживания и услуг

Änderungen vorbehalten · Subject to modification · Sous réserve de modifications · Con riserva di modifiche · Salvo modificaciones · Возможны изменения

Liebherr-Werk Ehingen GmbH · Postfach 1361 · 89582 Ehingen, Germany
Phone +49 73 91 5 02-0 · www.liebherr.com

**Get Your
Contact**

